

Disclaimer

The following online version of the Owner's Manual describes all models as well as all the standard and optional equipment of your vehicle. Country-specific differences in the language variants are possible. Note that your vehicle may not be fitted with all features described. This is also the case for safety-relevant systems and functions. Please contact your authorised Mercedes-Benz dealer if you would like to have a printed Owner's Manual for other vehicle models and vehicle model years. The online version is the current valid Owner's Manual version. Possible variations to your vehicle may not be taken into account as Mercedes-Benz constantly updates their vehicles and equipment to the state of the art and introduces changes in design and equipment. Please also read the printed Owner's Manual, any supplementary documents and the digital Owner's Manual in the vehicle.

Copyright

All Rights Reserved. All texts, images, graphics, are subject to Copyright and other laws for the protection of intellectual property. They may not be copied for commercial purposes or for transmission, nor changed and used on other websites.





A-Class

Owner's Manual

Mercedes-Benz



Symbols

In this manual, you will find the following symbols:

WARNING

Warning notes make you aware of dangers which could pose a threat to your health or life, or to the health and life of others.

Environmental note

Environmental notes provide you with information on environmentally aware actions or disposal.

 Notes on material damage alert you to dangers that could lead to damage to your vehicle.

 These symbols indicate useful instructions or further information that could be helpful to you.

▶ This symbol designates an instruction that you must follow.

▶ Several consecutive symbols indicate an instruction with several steps.

(▷ page) This symbol tells you where you can find further information on a topic.

Dis-
play This text indicates a message on the multifunction display/multimedia display.

Welcome to the world of Mercedes-Benz

Before you drive off for the first time, read this Owner's Manual carefully and familiarise yourself with your vehicle. For your own safety and a longer vehicle life, follow the instructions and warning notices in this manual. Disregarding them may lead to damage to the vehicle or personal injury.

The equipment or model designation of your vehicle may vary according to:

- model
- order
- country variant
- availability

The illustrations in this manual show a left-hand-drive vehicle. On right-hand-drive vehicles, the layout of components and controls differs accordingly.

Mercedes-Benz is constantly updating its vehicles to the state of the art.

Mercedes-Benz therefore reserves the right to introduce changes in the following areas:

- design
- equipment
- technical features

Consequently, the description may differ from your vehicle in some cases.

The following are integral components of the vehicle:

- Printed Owner's Manual
- Service Booklet
- Equipment-dependent supplements

Keep these documents in the vehicle at all times. If you sell the vehicle, always pass all documents on to the new owner.

- i** You can find out about important features of your vehicle in the interactive Owner's Manual on the internet at:

<http://www.mercedes-benz.de/betriebsanleitung>

You can also use the Mercedes-Benz Guides app:

Your Owner's Manuals:

i Digital – in the vehicle

The Digital Owner's Manual provides comprehensive and specifically adapted information on your vehicle's equipment and multimedia system. It contains informative

animations, individual language settings and an intuitive search function.

📖 Printed manual – in the vehicle

In addition to this manual and the aforementioned digital media, you also have the option to obtain a comprehensive printed version of the supplement for your multimedia system from your Mercedes-Benz Service Centre.

🌐 Digital – on the internet

The online Owner's Manual provides easy access to all information regarding your vehicle and multimedia system. It also provides helpful animations, interesting background information and a wide array of search options.

📱 Digital – as an app

Using the Mercedes-Benz Guides app, you can view all the information on your vehicle and multimedia system via mobile internet or download it to use without internet access. Available for smartphones or tablets.

You can also use the Mercedes-Benz Guides app:



Apple® iOS



Android™

Please note that the Mercedes-Benz Guides app may not yet be available in your country.

Index 4**Digital Owner's Manual 24**

Introduction 24

Operation 24

Introduction 25

Environmental protection 25

Genuine Mercedes-Benz parts 25

Owner's Manual 26

Operating safety 26

QR code for rescue card 28

Data stored in the vehicle 28

Copyright information 30

At a glance 31

Cockpit 31

Instrument cluster 33

Multifunction steering wheel 34

Centre console 35

Door control panel 38

Overhead control panel 39

Safety 40

Panic alarm 40

Occupant safety 40

Children in the vehicle 55

Pets in the vehicle 65

Driving safety systems 65

Protection against theft 73

Opening and closing 76

Keys 76

Doors 83

Luggage compartment 86

Side windows 88

Panorama sliding sunroof 92

Seats, steering wheel and mirrors 97

Correct driver's seat position 97

Seats 97

Steering wheel 102

Mirrors 103

Memory function 106

Lights and windscreen wipers 107

Exterior lighting 107

Interior lighting 111

Replacing bulbs 111

Windscreen wipers 115

Climate control 119

Overview of climate control systems ... 119

Operating the climate control systems 122

Air vents 132

Driving and parking 134

Running-in notes 134

Driving 134

DYNAMIC SELECT button (all vehicles except Mercedes-AMG vehicles) 143

DYNAMIC SELECT controller (Mercedes-AMG vehicles) 143

Manual transmission 144

Automatic transmission 145

Refuelling 154

Parking 157

Driving tips 160

Driving systems 164

Towing a trailer 196

On-board computer and displays 201

Important safety notes 201

Displays and operation 201

Menus and submenus 204

Display messages 217

Warning and indicator lamps on the instrument cluster 248

Multimedia system 261

General notes 261

Important safety notes 261

Function restrictions 261

Operating system 261

Stowing and features 271

Loading guidelines 271

Stowage areas 271

Features	277
----------------	-----

Maintenance and care 284

Engine compartment	284
ASSYST PLUS	289
Care	290

Breakdown assistance 297

Where will I find...?	297
Flat tyre	299
Battery (vehicle)	304
Jump-starting	307
Towing and tow-starting	309
Fuses	313

Wheels and tyres 316

Important safety notes	316
Operation	316
Winter operation	318
Tyre pressure	319
Changing a wheel	324
Wheel/tyre combinations	329
Emergency spare wheel	330

Technical data 332

Information on technical data	332
Vehicle electronics	332
Identification plates	333
Service products and capacities	334
Vehicle data	340
Trailer tow hitch	341

1, 2, 3 ...

4ETS (Electronic Traction System)

see ETS/4ETS (Electronic Traction System)

4MATIC

Display message 245

4MATIC (permanent four-wheel drive)

..... 178

12 V socket

see Sockets

A

ABS (Anti-lock Braking System)

Display message 219

Function/notes 65

Important safety notes 66

Warning lamp 251

Accident

Automatic measures after an accident 55

Activating media mode

General notes 270

Activating/deactivating air-recirculation mode

..... 126

Activating/deactivating cooling

with air dehumidification 123

Active Brake Assist

Activating or deactivating 211

Display message 225

Function/notes 66

ADAPTIVE BRAKE 73

Adaptive brake lights 69

Adaptive Damping System

Function/notes 178

Adaptive Highbeam Assist

Display message 232

Function/notes 110

Switching on/off 110

Additional speedometer 212

Additives (engine oil) 338

Address book

See also Digital Owner's Manual ... 261

Adjusting the headlamp range 109

Adjusting the volume

Multimedia system 262

Air conditioning

General notes 119

Air filter (white display message) 235

Air pressure

see Tyre pressure

Air vents

Important safety notes 132

Rear 133

Setting the centre air vents 133

Setting the side air vents 133

Air-conditioning system

see Climate control

Airbag

Automatic front-passenger front

airbag deactivation 48

Introduction 45

PASSENGER AIR BAG indicator

lamps 41

Airbags

Display message 228

Front airbag (driver, front passenger) 46

Important safety guidelines 45

Kneebag 47

Sidebag 47

Triggering 52

Windowbag 48

Alarm

ATA (Anti-Theft Alarm system) 73

Switching off (ATA) 73

Switching the function on/off (ATA) 73

Alarm system

see ATA (Anti-Theft Alarm system)

AMG

Performance Seat 101

RIDE CONTROL sports suspension 177

AMG menu (on-board computer) 215

AMG Performance exhaust system 141

AMG RIDE CONTROL

General Information 177

Anti-glare film 283

Anti-lock braking system

see ABS (Anti-lock Braking System)

Anti-skid chains

see Snow chains

- Anti-Theft Alarm system**
 - see ATA (Anti-Theft Alarm system)
- Anticipatory occupant protection**
 - see PRE-SAFE® (anticipatory occupant protection)
- Aquaplaning** 163
- Ashtray** 279
- Assistance display (on-board computer)** 210
- Assistance menu (on-board computer)** 210
- ASSYST PLUS**
 - Displaying a service message 289
 - Driving abroad 290
 - Hiding a service message 289
 - Information about Service 289
 - Resetting the service interval display 289
 - Service message 289
 - Special service requirements 289
- ATA (Anti-Theft Alarm system)**
 - Activating/deactivating 73
 - Function 73
 - Switching off the alarm 73
- ATTENTION ASSIST**
 - Activating/deactivating 211
 - Display message 236
 - Function/notes 190
- Audio menu (on-board computer)** ... 207
- Audio system**
 - see Digital Owner's Manual
- Authorised workshop**
 - see Qualified specialist workshop
- AUTO lights**
 - Display message 232
 - see Lights
- Automatic engine start (ECO start/stop function)** 140
- Automatic engine switch-off (ECO start/stop function)** 139
- Automatic front-passenger front airbag deactivation**
 - Display message 228
- Automatic front-passenger front airbag deactivation system**
 - Operation 48
 - Problems 52
- System self-test 51
- Automatic headlamp mode** 107
- Automatic transmission**
 - Accelerator pedal position 149
 - Changing gear 149
 - DIRECT SELECT lever 146
 - Drive program display 146
 - Drive programs 150
 - Driving tips 149
 - DYNAMIC SELECT button (all vehicles except Mercedes-AMG vehicles) 143
 - DYNAMIC SELECT controller (Mercedes-AMG vehicles) 143
 - Emergency running mode 154
 - Engaging drive position 147
 - Engaging neutral 147
 - Engaging park position (Mercedes-AMG vehicles) 148
 - Engaging park position automatically 146
 - Engaging reverse gear 147
 - Engaging the park position 146
 - Gliding mode 150
 - Holding the vehicle stationary on uphill gradients 149
 - Kickdown 149
 - Manual shifting 152
 - Oil temperature (on-board computer, Mercedes-AMG vehicles) 215
 - Overview 145
 - Problem (fault) 154
 - Pulling away 137
 - Selector lever 147
 - Starting the engine 137
 - Steering wheel gearshift paddles ... 152
 - Trailer towing 150
 - Transmission position display 148
 - Transmission position display (DIRECT SELECT lever) 146
 - Transmission positions 148
- Automatic transmission emergency running mode** 154
- Auxiliary heating**
 - Activating/deactivating 129
 - Activating/deactivating (on the centre console) 129
 - Remote control 129

- Setting 213
 - Auxiliary heating/ventilation**
 - Display message 246
 - Important safety notes 128
 - Problem (display message) 132
 - Setting the departure time 130
 - Auxiliary ventilation**
 - Activating/deactivating 129
 - Activating/deactivating (on the centre console) 129
 - Remote control 129
 - Axle load, permissible (trailer towing)** 341
- B**
- Back button** 262
 - Bag hook** 275
 - Ball coupling**
 - Folding in 199
 - Folding in/out 198
 - Folding out 198
 - BAS (Brake Assist System)** 66
 - Battery (key)**
 - Checking 79
 - Important safety notes 79
 - Replacing 79
 - Battery (vehicle)**
 - Charging 306
 - Display message 234
 - Important safety notes 304
 - Jump starting 307
 - Belt**
 - see Seat belts
 - Belt tensioner**
 - Activation 52
 - Belt warning** 45
 - Blind Spot Assist**
 - Activating/deactivating (on-board computer) 211
 - Display message 237
 - Notes/function 193
 - Trailer towing 194
 - Bluetooth®**
 - Searching for a mobile phone 265
 - Searching for a mobile phone (device manager) 266
 - See also Digital Owner's Manual ... 261
 - Telephony 264
 - Bonnet**
 - Active bonnet (pedestrian protection) 284
 - Closing 286
 - Display message 245
 - Important safety notes 284
 - Opening 285
 - Boot lid**
 - see Tailgate
 - Brake**
 - EBD 72
 - Brake Assist**
 - see BAS (Brake Assist System)
 - Brake fluid**
 - Display message 225
 - Notes 338
 - Brake force distribution**
 - see EBD (electronic brake force distribution)
 - Brake lamp**
 - Replacing bulbs 114
 - Brake lamps**
 - Adaptive 69
 - Display message 231
 - Brakes**
 - ABS 65
 - BAS 66
 - Brake fluid (notes) 338
 - Braking assistance appropriate to the situation 68
 - Display message 219
 - Driving tips 162
 - Hill start assist 138
 - HOLD function 174
 - Important safety notes 162
 - Parking brake 158
 - Warning lamp 250
 - Braking assistance appropriate to the situation**
 - Function/notes 68
 - Breakdown**
 - Where will I find...? 297
 - see Flat tyre
 - see Tow-starting
 - see Towing away
 - Brightness control (instrument cluster lighting)** 33

Buttons on the steering column 202

C

Calling up a fault

see Display messages

Car

see Vehicle

Car wash (care) 290

Care

Automatic car wash 290
 Carpets 296
 Display 295
 Exhaust pipe 294
 Exterior lighting 293
 Gear or selector lever 295
 High-pressure cleaner 291
 Interior 295
 Matt paintwork 292
 Notes 290
 Paint 291
 Plastic trim 295
 Reversing camera 294
 Roof lining 296
 Seat belt 296
 Seat cover 296
 Sensors 294
 Steering wheel 295
 Trim pieces 295
 Washing by hand 291
 Wheels 292
 Windows 293
 Wiper blades 293
 Wooden trim 295

CD

See also Digital Owner's Manual ... 261

CD player (on-board computer) 208

Central locking

Automatic locking (on-board computer) 213
 Locking/unlocking (key) 77

Centre console

Lower section 36
 Upper section 35

Changing a wheel

Wheels and tyres 325

Child

Restraint system 56

Child seat

Forward-facing restraint system 59
 ISOFIX 56
 On the front-passenger seat 58
 Rearward-facing restraint system 59
 Recommendations 62
 Suitable positions 59
 Top Tether 57

Child-proof locks

Important safety notes 64
 Rear doors 64

Children in the vehicle

Important safety notes 55

Cigarette lighter 280

Cleaning

Mirror turn signal 293
 Trailer tow hitch 294

Climate control

Air conditioning 120
 Auxiliary heating/ventilation 128
 Controlling automatically 123
 Convenience opening/closing (air-recirculation mode) 127
 Cooling with air dehumidification .. 123
 Demisting the windows 126
 Demisting the windscreen 125
 Indicator lamp 123
 Information on using THERMOTRONIC automatic climate control 122
 Notes on using the air-conditioning system 120
 Overview of systems 119
 Problem with the rear window heating 126
 Problems with cooling with air dehumidification 123
 Setting the air distribution 124
 Setting the air vents 132
 Setting the airflow 125
 Setting the temperature 124
 Switching air-recirculation mode on/off 126
 Switching on/off 122
 Switching residual heat on/off 128
 Switching the rear window heating on/off 126

Switching the ZONE function on/off	125
THERMOTRONIC (2-zone) automatic climate control	121
Cockpit	
Overview	31
see Instrument cluster	
COMAND display	
Cleaning	295
Combination switch	109
Connecting a USB device	
See also Digital Owner's Manual ...	261
Consumption statistics (on-board computer)	205
Controller	262
Convenience closing feature	90
Convenience opening feature	90
Convenience opening/closing (air-recirculation mode)	127
Coolant (engine)	
Checking the level	288
Display message	233
Important safety notes	339
Temperature (on-board computer, Mercedes-AMG vehicles)	215
Temperature gauge	202
Warning lamp	257
Cooling	
see Climate control	
Copyright	30
Cruise control	
Activation conditions	165
Cruise control lever	164
Deactivating	166
Display message	239
Driving system	164
Important safety notes	164
LIM indicator lamp	164
Selecting	165
Setting a speed	165
Storing and maintaining current speed	165
Cup holder	
Centre console	278
Important safety notes	277
Rear compartment	279

D

Dashboard	
see Instrument cluster	
Data	
see Technical data	
Data collection	
Processing and forwarding	28
Data modem mode	
Telephone module with Bluetooth® (SAP profile)	269
Daytime driving lights	
Display message	231
Function/notes	107
Switching on/off (on-board computer)	213
Dealership	
see Qualified specialist workshop	
Declarations of conformity	26
Decorative film	
Cleaning instructions	292
Diagnostics connection	27
Diesel	336
Digital Owner's Manual	
Help	24
Introduction	24
Digital speedometer	206
Dipped-beam headlamps	
Display message	230
Replacing bulbs	113
Setting for driving abroad (symmetrical)	107
Switching on/off	108
DIRECT SELECT lever	
Automatic transmission	146
Display message	
Driving systems	236
Display messages	
ASSYST PLUS	289
Calling up (on-board computer)	218
Engine	233
General information	217
Hiding (on-board computer)	218
Key	247
Lights	230
Safety systems	219
Tyres	240
Vehicle	242

- Distance Pilot DISTRONIC**
- Activating 170
 - Calling up the speed 170
 - Cruise control lever 169
 - Deactivating 172
 - Display Message 238
 - Displays in the instrument cluster .. 173
 - Displays in the multifunction display 173
 - Driving tips 174
 - Function/notes 168
 - Important safety notes 168
 - Selecting 170
 - Setting a speed 171
 - Setting the specified minimum distance 172
 - Stopping 171
 - Storing the speed 170
- Distance warning function**
- Function/notes 67
 - Warning lamp 259
- Distance warning signal (warning lamp)** 259
- Door**
- Automatic locking (on-board computer) 213
 - Automatic locking (switch) 85
 - Central locking/unlocking (key) 77
 - Control panel 38
 - Display message 245
 - Emergency locking 85
 - Emergency unlocking 85
 - Important safety notes 83
 - Opening (from the inside) 83
- Drive program**
- Display 148
 - Display (DIRECT SELECT lever) 146
 - Manual transmission 145
- Drive programs**
- Automatic transmission 150
- Driver's door**
- see Door
- Driving abroad**
- Mercedes-Benz Service 290
 - Symmetrical dipped beam 107
- Driving on flooded roads** 163
- Driving safety system**
- Active Brake Assist 66
 - Braking assistance appropriate to the situation 68
 - EBD (electronic brake force distribution) 72
 - STEER CONTROL 73
- Driving safety systems**
- ABS (Anti-lock Braking System) 65
 - ADAPTIVE BRAKE 73
 - Adaptive brake lights 69
 - BAS (Brake Assist System) 66
 - Distance warning function 67
 - ESP® (Electronic Stability Program) 69
 - Important safety guidelines 65
 - Overview 65
- Driving system**
- Distance Pilot DISTRONIC 168
 - DYNAMIC BODY CONTROL 178
 - Parking assist PARKTRONIC 178
 - Parking Pilot 181
 - RACE START (Mercedes-AMG vehicles) 176
 - Speed limiter 166
 - Start-off assist 176
- Driving systems**
- AMG RIDE CONTROL sports suspension 177
 - ATTENTION ASSIST 190
 - Blind Spot Assist 193
 - Cruise control 164
 - Display message 236
 - HOLD function 174
 - Lane Keeping Assist 194
 - Lane package 193
 - Reversing camera 186
 - Traffic Sign Assist 191
- Driving tips**
- Aquaplaning 163
 - Automatic transmission 149
 - Brakes 162
 - Distance Pilot DISTRONIC 174
 - Downhill gradient 162
 - Driving abroad 107
 - Driving in winter 163
 - Driving on flooded roads 163
 - Driving on wet roads 163
 - Fuel 160
 - General 160

- Icy road surfaces 163
 Limited braking efficiency on salted roads 163
 New brake pads/linings 163
 Running-in tips 134
 Snow chains 319
 Symmetrical dipped beam 107
 The first 1500 km 134
 Towing a trailer 197
 Wet road surface 162
- DVD video**
 Operating (on-board computer) 208
 See also Digital Owner's Manual ... 261
- DYNAMIC SELECT button (all vehicles except Mercedes-AMG vehicles)** 143
- DYNAMIC SELECT controller** 143
- DYNAMIC SELECT controller (Mercedes-AMG vehicles)** 143
- DYNAMIC SELECT switch**
 Climate control (air conditioning) .. 121
 Climate control (THERMOTRONIC) 122
- E**
- EASY-PACK tailgate**
 see Tailgate
- EBD (electronic brake force distribution)**
 Display message 221
 Function/notes 72
- ECO display**
 Function/notes 160
 On-board computer 205
- ECO start/stop function**
 Deactivating/activating 140
 General information 139
 Important safety notes 139
 Introduction 139
- Electromagnetic compatibility**
 Declaration of conformity 26
- Electronic Stability Program**
 see ESP® (Electronic Stability Program)
- Emergency**
 Automatic measures after an accident 55
- Emergency key**
 Unlocking the driver's door 85
- Emergency key element**
 Function/notes 78
 Inserting 79
 Locking vehicle 85
 Removing 79
- Emergency release**
 Driver's door 85
- Emergency spare wheel**
 General notes 330
 Important safety notes 330
 Removing 331
- Emergency unlocking**
 Vehicle 85
- Engine**
 Display message 233
 ECO start/stop function 139
 Engine number 334
 Jump-starting 307
 Running irregularly 141
 Starting (important safety notes) ... 136
 Starting problems 141
 Starting the engine with the key 137
 Starting with the Start/Stop button 137
 Stopping 157
 Tow-starting (vehicle) 313
 Warning lamp (engine diagnostics) 256
- Engine electronics**
 Notes 332
 Problem (fault) 141
- Engine jump starting**
 see Jump starting (engine)
- Engine oil**
 Additives 338
 Checking the oil level 286
 Checking the oil level using the dipstick 286
 Display message 234
 Filling capacity 338
 Notes about oil grades 337
 Notes on oil level/consumption 286
 Temperature (on-board computer, Mercedes-AMG vehicles) 215
 Topping up 287

- Entering an address**
See also Digital Owner's Manual ... 261
- Environmental protection**
Returning an end-of-life vehicle 25
- ESP® (Electronic Stability Program)**
AMG menu (on-board computer) ... 215
Characteristics 70
Deactivating/activating (button in Mercedes-AMG vehicles) 71
Deactivating/activating (except Mercedes-AMG vehicles) 70
Deactivating/activating (on-board computer, except Mercedes-AMG vehicles) 210
Display message 219
Function/notes 69
General notes 69
Important safety guidelines 69
Trailer stabilisation 72
Warning lamp 253
- ETS/4ETS (Electronic Traction System)** 69
- Exhaust**
see Exhaust pipe
- Exhaust pipe**
Cleaning 294
- Exterior lighting**
Cleaning 293
see Lights
- Exterior mirrors**
Adjusting 103
Anti-dazzle mode (automatic) 105
Folding in when locking (on-board computer) 215
Folding in/out (automatically) 104
Folding in/out (electrically) 104
Out of position (troubleshooting) ... 105
Parking position 105
Resetting 104
Storing settings (memory function) 106
- F**
- Fault message**
see Display messages
- Favourites**
Overview 262
- Filler cap**
see Fuel filler flap
- Fire extinguisher** 298
- First-aid kit** 298
- Fitting a wheel**
Fitting a wheel 328
Lowering the vehicle 328
Preparing the vehicle 325
Raising the vehicle 326
Removing a wheel 328
Securing the vehicle against rolling away 326
- Flat tyre**
Changing a wheel/fitting the spare wheel 324
MOExtended tyres 300
Preparing the vehicle 299
TIREFIT kit 301
see Emergency spare wheel
- Floormat** 283
- Frequencies**
Mobile phone 332
Two-way radio 332
- Front-passenger front airbag deactivation**
Display message 228
- Front-passenger front airbag deactivation system**
Operation 48
Problems 52
System self-test 51
- Fuel**
Additives 336
Consumption statistics 205
Displaying the current consumption 205
Displaying the range 205
Driving tips 160
E10 335
Fuel gauge 33
Grade (petrol) 335
Important safety notes 335
Low outside temperatures 337
Notes for Mercedes-AMG vehicles 336
Problem (malfunction) 156

Quality (diesel)	336
Refuelling	154
Tank content/reserve fuel	335
Fuel filler flap	
Opening	155
Fuel filter (white display message) ..	235
Fuel level	
Calling up the range (on-board computer)	205
Gauge	33
Fuel reserve	
see Fuel	
Fuel tank	
Capacity	335
Problem (malfunction)	156
Fuses	
Allocation chart	314
Before changing	313
Fuse box in the engine compartment	314
Fuse box in the front-passenger footwell	314
Important safety notes	313

G

Gear indicator (on-board computer, Mercedes-AMG vehicles)	215
Genuine Mercedes-Benz parts	25
Glove compartment	272
Google™ Local Search	
See also Digital Owner's Manual ...	261

H

Hazard warning lamps	
Display message	247
Switching on/off	109
Head restraints	
Adjusting	99
Adjusting (manually)	100
Adjusting (rear)	100
Fitting/removing (rear)	101
Headlamp flasher	109
Headlamps	
Misting up	110
see Automatic headlamp mode	

Heating

 see Climate control

High-pressure cleaners 291

Hill start assist 138

HOLD function

 Activating
 175 |

 Activation conditions
 175 |

 Deactivating
 175 |

 Display message
 236 |

 Function/notes
 174 |

Home address

 See also Digital Owner's Manual ...
 261 |

Horn 31

I

Ignition lock

 see Key positions

Immobiliser 73

Indicator and warning lamp

 Restraint system
 256 |

Indicator and warning lamps

Coolant
 257 |

Engine diagnostics
 256 |

SPORT handling mode
 254 |

Indicator lamps

Display message
 230 |

see Warning and indicator lamps

Indicators

see Turn signals

Instrument cluster

Overview
 33 |

Settings
 212 |

Warning and indicator lamps
 33 |

Instrument cluster lighting 201

Interior lighting

Control
 111 |

Overview
 111 |

Reading lamp
 111 |

Interior motion sensor

Deactivating
 75 |

Function
 74 |

Priming
 74 |

Switching off
 75 |

iPod®

See also Digital Owner's Manual ...
 261 |

ISOFIX child seat securing system 56

J**Jack**

Declaration of conformity	26
Storage location	299
Using	326

Jump starting (engine)	307
-------------------------------------	-----

K**Key**

Changing the battery	79
Checking the battery	79
Convenience closing feature	90
Convenience opening feature	90
Display message	247
Door central locking/unlocking	77
Emergency key element	78
Important safety notes	76
Loss	81
Modifying the programming	78
Positions (ignition lock)	135
Problem (malfunction)	81
Starting the engine	137

Key positions

Start/Stop button	135
-------------------------	-----

Key positions (ignition lock)	135
--	-----

KEYLESS-GO

Convenience closing	90
Deactivation	77
Locking	77
Unlocking	77

Kickdown

Driving tips	149
Manual gearshifting	154

Kneebag	47
----------------------	----

L**Lamps**

see Warning and indicator lamps

Lane Keeping Assist

Activating/deactivating (on-board computer)	211
Display message	236
Function/information	194

Lane package	193
---------------------------	-----

Lap time (RACETIMER)	216
-----------------------------------	-----

Lashing eyelets	275
------------------------------	-----

Licence plate lamp (display message)

231

Light sensor (display message)	232
---	-----

Lighting

see Lights

Lights

Adaptive Highbeam Assist	110
Automatic headlamp mode	107
Dipped-beam headlamps	108
Driving abroad	107
Hazard warning lamps	109
Headlamp flasher	109
Headlamp range	109
Light switch	107
Main-beam headlamps	109
Misted up headlamps	110
Parking lamps	108
Rear foglamp	108
Setting exterior lighting	107
Side lamps	108
Switching the daytime driving lights on/off (on-board computer)	213
Turn signals	109

LIM indicator lamp

Cruise control	164
Distance Pilot DISTRONIC	169
Variable limiter	167

Limiter

Calling up the speed	167
Deactivating, variable	168
Function/notes	166
LIM indicator lamp	167
Permanent	168
Setting a speed	167
Storing the current speed	167
Switching to passive	167
Variable	167

Limiting the speed

Speed limiter	166
---------------------	-----

Loading guidelines	271
---------------------------------	-----

Locking

see Central locking

Locking (doors)

Automatic	85
Emergency locking	85
From inside (central locking button)	84

- Locking centrally**
see Central locking
- Locking verification signal (on-board computer)** 213
- Luggage compartment enlargement** 274
- Luggage compartment floor**
Important safety notes 276
opening/closing 276
stowage well, under 276
- Lumbar support**
Adjusting the 4-way lumbar support 101
- M**
- M+S tyres** 318
- Main-beam headlamps**
Adaptive Highbeam Assist 110
Display message 231
Replacing bulbs 113
Switching on/off 109
- Maintenance**
see ASSYST PLUS
- Manual transmission**
Drive program 145
DYNAMIC SELECT button 143
Engaging reverse gear 145
Gear lever 144
Pulling away 137
Shift recommendation 145
Shifting to neutral 144
Starting the engine 137
- Matt finish (cleaning instructions)** .. 292
- Memory card (audio)** 208
- Memory function** 106
- Mercedes-Benz emergency call system**
Switch in the overhead control panel 281
- Mercedes-Benz Intelligent Drive**
Traffic Sign Assist 191
- Mercedes-Benz Service Centre**
see Qualified specialist workshop
- Message memory (on-board computer)** 218
- Messages**
see Display messages
- Mirror turn signal**
Cleaning 293
- Mirrors**
see Exterior mirrors
see Rear-view mirror
see Vanity mirror (in sun visor)
- Mobile phone**
Connecting (Bluetooth® interface) 264
Connecting (device manager) 265
Connecting the telephone module with Bluetooth® (SAP profile) 268
Frequencies 332
Installation 332
Menu (on-board computer) 208
Notes/placing in the bracket 281
Transmission output (maximum) ... 332
- Mobile telephone**
Pre-installed bracket 282
- Modifying the programming (key)** 78
- MOExtended tyres** 300
- MP3**
Operating 208
See also Digital Owner's Manual ... 261
- Multifunction display**
Function/notes 204
Permanent display 212
- Multifunction steering wheel**
Operating the on-board computer .. 202
Overview 34
- Multimedia system**
Switching on and off 262
- Music files**
See also Digital Owner's Manual ... 261
- N**
- Navigation**
Entering a destination 263
Menu (on-board computer) 206
See also Digital Owner's Manual ... 261
- Notes on running in a new vehicle** .. 134
- O**
- Occupant safety**
Airbags 45

- Automatic front-passenger front airbag deactivation 48
 - Automatic measures after an accident 55
 - Belt warning 45
 - Children in the vehicle 55
 - Important safety notes 40
 - PASSENGER AIRBAG indicator lamp 41
 - Pets in the vehicle 65
 - PRE-SAFE® (anticipatory occupant protection) 54
 - Restraint system introduction 40
 - Restraint system warning lamp 41
 - Seat belts 42
 - Odometer** 205
 - On-board computer**
 - AMG menu 215
 - Assistance graphic menu 210
 - Assistance menu 210
 - Audio menu 207
 - Convenience submenu 214
 - Display messages 217
 - Displaying a service message 289
 - Factory settings 215
 - Heating submenu 213
 - Important safety notes 201
 - Instrument cluster submenu 212
 - Light submenu 213
 - Menu overview 204
 - Message memory 218
 - Navigation menu 206
 - Operating the TV 208
 - Operating video DVD 208
 - Operation 202
 - RACETIMER 216
 - Service menu 211
 - Settings menu 212
 - Standard display 205
 - Telephone menu 208
 - Trip menu 205
 - Vehicle submenu 213
 - Opening and closing the side trim panels** 113
 - Operating instructions**
 - Vehicle equipment 26
 - Operating safety**
 - Declaration of conformity 26
 - Operating system**
 - see On-board computer
 - Operation**
 - Digital Owner's Manual 24
 - Outside temperature display** 201
 - Overhead control panel** 39
 - Override feature**
 - Rear side windows 65
- P**
- Paint code** 333
 - Paintwork (cleaning instructions)** ... 291
 - Panic alarm** 40
 - Panorama sliding sunroof**
 - Important safety information 92
 - Operating 93
 - Operating the roller sunblinds for the sliding sunroof 94
 - Problem (malfunction) 95
 - Rain-closing feature (when driving) 94
 - Rain-closing feature (when the engine is switched off) 94
 - Reversing feature 93
 - Parking**
 - Important safety notes 157
 - Parking brake 158
 - Parking position for the exterior mirror on the front-passenger side 105
 - Reversing camera 186
 - Parking aid**
 - see Exterior mirrors
 - see Reversing camera
 - Parking Assist PARKTRONIC**
 - Deactivating/activating 180
 - Driving system 178
 - Function/notes 178
 - Important safety notes 178
 - Problems (faults) 181
 - Sensor range 179
 - Warning display 180
 - Parking assistance**
 - see Parking Assist PARKTRONIC
 - Parking brake**
 - Applying automatically (vehicles with automatic transmission) 159

- Applying automatically (vehicles with manual transmission) 159
 - Applying or releasing manually 159
 - Display message 221
 - Electric parking brake 158
 - Emergency braking 160
 - General information 158
 - Releasing automatically 160
 - Warning lamp 256
 - Parking lamps**
 - Display message 231
 - Switching on/off 108
 - Parking Pilot**
 - Cancelling 185
 - Detecting parking spaces 182
 - Display Message 237
 - Exiting a parking space 184
 - Function/notes 181
 - Important safety notes 181
 - Parking 183
 - Towing a trailer 181
 - PASSENGER AIR BAG**
 - Display message 228
 - Indicator lamps 41
 - Problems (malfunctions) 228
 - Petrol** 335
 - Pets in the vehicle** 65
 - Phone book**
 - See also Digital Owner's Manual ... 261
 - Plastic trim (cleaning instructions)** 295
 - Power windows**
 - see Side windows
 - PRE-SAFE® (anticipatory occupant protection)**
 - Operation 54
 - PRE-SAFE® (preventive occupant safety system)**
 - Display message 225
 - Protection against theft**
 - ATA (Anti-Theft Alarm system) 73
 - Immobiliser 73
 - Interior motion sensor 74
 - Tow-away protection 74
 - Protection of the environment**
 - General notes 25
 - Pulling away**
 - Automatic transmission 137
 - General notes 137
 - Hill start assist 138
 - Manual transmission 137
 - Trailer 138
- Q**
- QR code**
 - Mercedes-Benz Guide App 1
 - Rescue card 28
 - Qualified specialist workshop** 28
- R**
- RACE START**
 - important safety notes 176
 - RACE START (Mercedes-AMG vehicles)** 176
 - RACE TIMER (on-board computer, Mercedes-AMG vehicles)** 216
 - Radio**
 - Selecting a station 207
 - see Digital Owner's Manual
 - Radio mode**
 - See also Digital Owner's Manual ... 261
 - Radio-based vehicle components**
 - Declaration of conformity 26
 - Rain closing feature (panorama sliding sunroof)** 94
 - Reading lamp** 111
 - Rear bench seat**
 - Folding the backrest forwards/back 274
 - Rear compartment**
 - Setting the air vents 133
 - Rear foglamp**
 - Changing the bulb 114
 - Display message 231
 - Switching on/off 108
 - Rear lamps**
 - see Lights
 - Rear shelf** 275
 - Rear window heating**
 - Problem (fault) 126
 - Switching on/off 126

- Rear window wiper**
 - Replacing the wiper blade 117
 - Switching on/off 115
- Rear-compartment seat belt status indicator** 45
- Rear-view mirror**
 - Anti-dazzle mode (automatic) 105
 - Dipping (manual) 103
- Reflective safety vest** 297
- Refuelling**
 - Fuel gauge 33
 - Important safety notes 154
 - Notes for Mercedes-AMG vehicles 336
 - Refuelling process 155
 - see Fuel
- Remote control**
 - Auxiliary heating/ventilation 129
 - Changing the batteries (auxiliary heating) 131
- Replacing bulbs**
 - Brake lamp 114
 - Dipped-beam headlamps 113
 - Fitting/removing the cover (front wheel arch) 112
 - Important safety notes 111
 - Main-beam headlamps 113
 - Overview of bulb types 112
 - Rear fog lamp 114
 - Reversing lamp 114
 - Turn signals (front) 113
 - Turn signals (rear) 114
- Replacing the battery (auxiliary heating remote control)** 131
- Rescue card** 28
- Reserve (fuel tank)**
 - see Fuel
- Reserve fuel**
 - Display message 235
 - Warning lamp 256
- Residual heat (climate control)** 128
- Restraint system**
 - Display message 227
 - Introduction 40
 - Warning lamp 256
 - Warning lamp (function) 41
- Rev counter** 201
- Reverse gear**
 - Engaging (manual transmission) 145
- Reverse gear (selector lever)** 147
- Reversing camera**
 - "Reverse parking" function 188
 - Cleaning instructions 294
 - Coupling up a trailer function 189
 - Display in the multimedia system .. 187
 - Function/notes 186
 - General notes 186
 - Switching on/off 186
- Reversing feature**
 - Side windows 89
 - Tailgate 86
- Reversing function**
 - Roller sunblind 94
- Reversing lamp**
 - Replacing bulbs 114
- Reversing lamps**
 - Display message 231
- Roller sunblind**
 - Panorama sliding sunroof 94
- Roof carrier** 276
- Roof lining and carpets (cleaning instructions)** 296
- Roof load (maximum)** 340
- Route guidance**
 - See also Digital Owner's Manual ... 261

S

- Safety**
 - Children in the vehicle 55
 - see Occupant safety
- Safety system**
 - see Driving safety systems
- SD card**
 - Inserting 270
 - Inserting/removing 270
 - Removing 270
- SD memory card**
 - See also Digital Owner's Manual ... 261
- Seat**
 - Adjusting (Performance Seat) 101
 - Correct driver's seat position 97
 - Folding the backrest (rear compartment) forwards/back 274

- Seat belt**
 - Correct usage 43
 - Switching belt adjustment on/off (on-board computer) 214
- Seat belts**
 - Adjusting the driver's and front-passenger seat belt 44
 - Adjusting the height 44
 - Cleaning 296
 - Display message 226
 - Fastening 44
 - Important safety guidelines 42
 - Introduction 42
 - Rear seat belt status indicator 45
 - Releasing 44
 - Warning lamp 249
 - Warning lamp (function) 45
- Seats**
 - Adjusting (electrically) 99
 - Adjusting (manually) 98
 - Adjusting the 4-way lumbar support 101
 - Adjusting the head restraint 99
 - Cleaning the cover 296
 - Important safety notes 97
 - Seat heating problem 102
 - Storing settings (memory function) 106
 - Switching seat heating on/off 101
- Section**
 - Luggage compartment 86
- Securing luggage** 275
- Selector lever**
 - Cleaning 295
- Sensors (cleaning instructions)** 294
- Service**
 - see ASSYST PLUS
- Service Centre**
 - see Qualified specialist workshop
- Service menu (on-board computer)** 211
- Service message**
 - see ASSYST PLUS
- Service products**
 - Brake fluid 338
 - Coolant (engine) 339
 - Engine oil 337
 - Fuel 334
 - Important safety notes 334
 - Washer fluid 339
- Setting the air distribution** 124
- Setting the airflow** 125
- Setting the date/time format**
 - See also Digital Owner's Manual ... 261
- Setting the language**
 - See also Digital Owner's Manual ... 261
- Setting the time**
 - See also Digital Owner's Manual ... 261
- Settings**
 - Factory (on-board computer) 215
 - On-board computer 212
- SETUP (on-board computer, Mercedes-AMG vehicles)** 215
- Shifting to neutral (manual transmission)** 144
- Side lamps**
 - Switching on/off 108
- Side windows**
 - Convenience closing 90
 - Convenience opening 90
 - Important safety notes 88
 - Opening/closing 89
 - Problem (malfunction) 91
 - Resetting 91
 - Reversing feature 89
- Sidebag** 47
- SIM card**
 - Inserting 268
- Sliding sunroof**
 - see Panorama sliding sunroof
- SMS**
 - See also Digital Owner's Manual ... 261
- Snow chains** 319
- Socket**
 - Luggage compartment 281
- Sockets**
 - Centre console 281
 - General notes 280
 - Rear compartment 281
- Sound**
 - Switching on/off 262
- Specialist workshop** 28
- Spectacles compartment** 272
- Speed limiter**
 - Display message 239

- Important safety notes 166
 - Selecting 167
 - Speed, controlling**
 - see Cruise control
 - Speedometer**
 - Activating/deactivating the additional speedometer 212
 - Digital 206
 - In the Instrument cluster 33
 - Segments 201
 - Selecting a display unit 212
 - SPORT handling mode**
 - Deactivating/activating (Mercedes-AMG vehicles) 71
 - Warning lamp 254
 - Start-off assist**
 - Activating 176
 - Important safety notes 176
 - Start/Stop button**
 - Removing 136
 - Starting the engine 137
 - Start/stop function**
 - see ECO start/stop function
 - Starting (engine) 136**
 - STEER CONTROL 73**
 - Steering**
 - Display message 246
 - Steering assistant STEER CONTROL**
 - see STEER CONTROL
 - Steering wheel**
 - Adjusting (manually) 103
 - Button overview 34
 - Buttons (on-board computer) 202
 - Cleaning 295
 - Gearshift paddles 152
 - Important safety notes 102
 - Steering wheel gearshift paddles 152**
 - Stopwatch (RACETIMER) 216**
 - Stowage compartment**
 - Map pockets 273
 - Stowage compartments**
 - Armrest (front) 272
 - Armrest (under) 273
 - Centre console 272
 - Centre console (rear) 273
 - Cup holder 277
 - Glove compartment 272
 - Important safety information 271
 - Spectacles compartment 272
 - Stowage net 273**
 - Stowage space**
 - Stowage net 273
 - Summer tyres 318**
 - Sun visor 279**
 - Suspension settings**
 - AMG RIDE CONTROL sports suspension 177
 - Switching on media mode**
 - Via the device list 270
- T**
- Tail lamps**
 - see Lights
 - Tailgate**
 - Display message 245
 - Emergency unlocking 88
 - Important safety notes 86
 - Limiting the opening angle 88
 - Obstruction detection 86
 - Opening dimensions 340
 - Opening/closing (from outside) 87
 - Opening/closing automatically from inside 87
 - Tank**
 - see Fuel tank
 - Technical data**
 - Capacities 334
 - Information 332
 - Trailer loads 341
 - Tyres/wheels 329
 - Vehicle data 340
 - Telephone**
 - Accepting a call (multifunction steering wheel) 209
 - Authorising a mobile phone (connecting) 265
 - Authorising a mobile phone via the device manager (connecting) ... 266
 - Connecting a mobile phone (device manager) 265
 - Connecting a Mobile phone (general information) 264
 - Display message 247
 - Introduction 208

- Menu (on-board computer) 208
- Number from the phone book 209
- Redialling 209
- Rejecting/ending a call 209
- See also Digital Owner's Manual ... 261
- Telephone compartment 273
- Telephone module with Bluetooth®
(SAP profile)**
 - Activating and connecting the module 267
 - Charging a mobile phone 269
 - Connecting the mobile phone 268
 - Connecting the module via a USB cable 267
 - Data modem mode 269
 - Installing the module 267
 - Introduction 267
 - Saving/deleting the PIN for the SIM card 269
 - Settings 269
 - SIM card mode 268
 - Text messages 269
 - Transferring the phone book 269
- Temperature**
 - Coolant 202
 - Coolant (on-board computer, Mercedes-AMG vehicles) 215
 - Engine oil (on-board computer, Mercedes-AMG vehicles) 215
 - Outside temperature 201
 - Setting (climate control) 124
 - Transmission oil (on-board computer, Mercedes-AMG vehicles) 215
- TEMPOMAT**
 - Function/notes 164
- Text messages**
 - Telephone module with Bluetooth® (SAP profile) 269
- Through-loading** 273
- Timing (RACETIMER)** 216
- TIREFIT kit** 301
 - Declaration of conformity 27
 - Important safety notes 301
 - Storage location 299
 - Tyre pressure not reached 303
 - Tyre pressure reached 303
- Top Tether** 57
- Total distance recorder** 205
- Tow-away protection**
 - Activating 74
 - Deactivating 74
 - Function 74
- Tow-starting**
 - Emergency engine starting 313
 - Fitting the towing eye 310
 - Important safety notes 309
 - Removing the towing eye 311
- Towing**
 - Important safety notes 309
 - Notes for 4MATIC vehicles 312
 - Transporting the vehicle 312
- Towing a trailer**
 - Axle load, permissible 341
 - ESP® (Electronic Stability Program) 72
 - Failure check for LEDs 200
 - General notes 197
 - Parking Pilot 181
 - Pulling away with a trailer 138
 - Trailer tow hitch display message .. 246
- Towing away**
 - Fitting the towing eye 310
 - Removing the towing eye 311
 - With both axles on the ground 311
 - With front axle raised 311
- Towing eye** 299
- Traffic Sign Assist**
 - Activating 192
 - Activating/deactivating the warning function 210
 - Display message 238
 - Function/notes 191
 - Important safety notes 192
 - Instrument cluster display 192
- Trailer**
 - Folding the ball coupling in/out 198
- Trailer coupling**
 - see Towing a trailer
- Trailer towing**
 - 7-pin connector 200
 - Blind Spot Assist 194
 - Cleaning the trailer tow hitch 294
 - Coupling up a trailer 199
 - Decoupling a trailer 199
 - Driving tips 197

- Folding in the ball coupling 199
 - Folding out the ball coupling 198
 - Important safety notes 196
 - Lights display message 230
 - Mounting dimensions 341
 - Power supply 199
 - Trailer loads 341
 - Transmission**
 - see Automatic transmission
 - see Manual transmission
 - Transmission position display (DIRECT SELECT lever)** 146
 - Transporting the vehicle** 312
 - Trim pieces (cleaning instructions)** 295
 - Trip computer (on-board computer)** 205
 - Trip meter**
 - Calling up 205
 - Resetting (on-board computer) 206
 - Turn signal lamp**
 - Replacing bulbs (rear) 114
 - Turn signals**
 - Replacing bulbs (front) 113
 - Switching on/off 109
 - TV**
 - Operating (on-board computer) 208
 - see Digital Owner's Manual
 - Two-way radio**
 - Frequencies 332
 - Installation 332
 - Transmission output (maximum) 332
 - Type identification plate**
 - see Vehicle identification plate
 - Tyre inflation compressor**
 - see TIREFIT kit
 - Tyre pressure**
 - Calling up (on-board computer) 322
 - Display message 240
 - Not reached (TIREFIT) 303
 - Reached (TIREFIT) 303
 - Recommended 319
 - Tyre pressure loss warning**
 - General notes 321
 - Important safety notes 321
 - Restarting 321
 - Tyre pressure monitor**
 - Checking the tyre pressure electronically 322
 - Function/notes 322
 - General notes 322
 - Important safety notes 322
 - Radio type approval for the tyre pressure monitor 324
 - Restarting 323
 - Warning lamp 260
 - Warning message 323
 - Tyres**
 - Changing a wheel 324
 - Checking 316
 - Direction of rotation 325
 - Display message 240
 - General notes 329
 - Important safety notes 316
 - Information on driving 316
 - M+S tyres 318
 - MOExtended tyres 318
 - Replacing 324
 - Service life 317
 - Storing 325
 - Summer tyres 318
 - Tyre size (data) 329
 - Tyre tread 317
 - see Flat tyre
- ## U
- Unlocking**
 - Emergency unlocking 85
 - From inside the vehicle (central unlocking button) 84
 - Upshift indicator (on-board computer, Mercedes-AMG vehicles)** 215
 - USB devices**
 - Connecting to the Media Interface 270
- ## V
- Vanity mirror (in sun visor)** 279
 - Vehicle**
 - Correct use 28
 - Display message 242
 - Electronics 332
 - Equipment 26

- Implied warranty 28
 - Individual settings 212
 - Leaving parked up 160
 - Locking (in an emergency) 85
 - Locking (key) 77
 - Lowering 328
 - Pulling away 137
 - Raising 326
 - Registration 28
 - Securing from rolling away 326
 - Transporting 312
 - Unlocking (in an emergency) 85
 - Unlocking (key) 77
 - Vehicle data 340
 - Vehicle data** 340
 - Roof load (maximum) 340
 - Vehicle dimensions** 340
 - Vehicle emergency locking** 85
 - Vehicle identification number**
 - see VIN
 - Vehicle identification plate** 333
 - Vehicle tool kit** 299
 - Ventilation**
 - Setting the vents 132
 - Video**
 - Operating the DVD 208
 - See also Digital Owner's Manual ... 261
 - VIN**
 - Seat 334
 - Type plate 333
-
- W**
- Warning and indicator lamps**
 - ABS 251
 - Active Brake Assist 259
 - Brakes 250
 - Distance warning signal 259
 - ESP® 253
 - ESP® OFF 254
 - Fuel tank 256
 - LIM (cruise control) 164
 - LIM (Distance Pilot DISTRONIC) 169
 - LIM (variable limiter) 167
 - Overview 33
 - PASSENGER AIR BAG 41
 - Reserve fuel 256
 - Seat belt 249
 - Tyre pressure monitor 260
 - Warning triangle** 298
 - Washer fluid**
 - Display message 247
 - Weather display (COMAND Online)**
 - See also Digital Owner's Manual ... 261
 - Wheel and tyre combinations**
 - Tyres 329
 - Wheel bolt tightening torque** 328
 - Wheel chock** 326
 - Wheels**
 - Changing a wheel 324
 - Changing/replacing 324
 - Checking 316
 - Cleaning 292
 - Emergency spare wheel 330
 - Fitting a new wheel 328
 - Important safety notes 316
 - Information on driving 316
 - Removing a wheel 328
 - Storing 325
 - Tightening torque 328
 - Wheel size/tyre size 329
 - Wheels and tyres**
 - Changing a wheel 325
 - Windowbag**
 - Display message 227
 - Operation 48
 - Windows**
 - Cleaning 293
 - see Side windows
 - Windscreen**
 - Demisting 125
 - Windscreen washer fluid**
 - see Windscreen washer system
 - Windscreen washer system**
 - Important safety notes 339
 - Topping up 288
 - Windscreen wipers**
 - Display message 247
 - Problem (malfunction) 118
 - Rear window wiper 115
 - Replacing the wiper blades 116
 - Switching on/off 115
 - Winter driving**
 - General notes 318
 - Winter operation**
 - Slippery road surfaces 163

Snow chains	319
Winter tyres	
Limiting the speed (on-board com- puter)	213
M+S tyres	318
Wiper blades	
Cleaning	293
Important safety notes	116
Replacing (on the rear window)	117
Wooden trim (cleaning instruc- tions)	295
Workshop	
see Qualified specialist workshop	

Z

ZONE function	
Switching on/off	125

Introduction

The printed Owner's Manual provides information about the safe operation of your vehicle. The Digital Owner's Manual provides comprehensive and specifically adapted information on your vehicle's equipment and multimedia system. You can call up the Digital Owner's Manual via the multimedia system.

- i** You will not incur any costs when calling up the Digital Owner's Manual. The Digital Owner's Manual works without connecting to the internet.

There are three ways to access the topics of the Digital Owner's Manual:

• Visual search

The visual search allows you to explore your vehicle "virtually". Starting from either the vehicle exterior view or interior view, you can access many of the different topics covered by the Digital Owner's Manual. To access the vehicle interior section, select the "Vehicle interior" view.

• Keyword search

The keyword search allows you to search for a keyword by entering characters.





• Contents

You can select individual sections in the contents.

- i** The Digital Owner's Manual is deactivated for safety reasons while driving.

Operation

Calling up the Digital Owner's Manual

- ▶ Press the  button on the centre console. The vehicle overview appears.
- ▶ Select the "Owner's Manual" menu item by turning  or pressing  the controller.
- ▶ Acknowledge  the message about the warning and safety notes. The basic menu for the Digital Owner's Manual appears.

Operating the Digital Owner's Manual





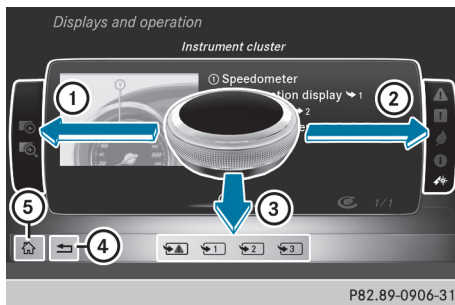

General notes

Please observe the information about the operation of the controller (▶ page 262).

Content pages

You can access the pages of content by means of a visual search or a keyword search or by using the table of contents.



- ▶ **To scroll forwards/backwards:** turn  the controller.
- ▶ **To display in full-screen or animation:** slide  the controller to the left **1**.
- ▶ **To select information text or save bookmarks:** slide  the controller to the right **2**.
- ▶ **To select a link:** slide  the controller downwards **3**.
- ▶ **To exit a content page:** select the  symbol **4**.
- ▶ **To call up the basic menu of the Digital Owner's Manual:** select the  symbol **5**.
- ▶ **To switch functions to the multimedia system using the buttons on the centre console:** press the **RADIO**, **TEL**, **MEDIA** or **NAVI** button. The selected menu appears. The Digital Owner's Manual remains open in the background.

Environmental protection

General notes

Environmental note

Daimler's declared policy is one of comprehensive environmental protection.

Our objectives are to use the natural resources which form the basis of our existence on this planet sparingly and in a manner which takes the requirements of both nature and humanity into consideration.

You too can help to protect the environment by operating your vehicle in an environmentally-responsible manner.

Fuel consumption and the rate of engine, transmission, brake and tyre wear depend on the following factors:

- operating conditions of your vehicle
- your personal driving style

You can influence both factors. Therefore, please bear the following in mind:

Operating conditions:

- avoid short trips, as these increase fuel consumption.
- observe the correct tyre pressure.
- do not carry any unnecessary weight in the vehicle.
- remove the roof rack once you no longer need it.
- a regularly serviced vehicle will contribute to environmental protection. You should therefore adhere to the service intervals.
- all maintenance work should be carried out at a qualified specialist workshop.

Personal driving style:

- do not depress the accelerator pedal when starting the engine.
- do not warm up the engine when the vehicle is stationary.
- drive carefully and maintain a safe distance from the vehicle in front.
- avoid frequent, sudden acceleration and braking.

- change gear in good time and use each gear only up to $\frac{2}{3}$ of its maximum engine speed.
- switch off the engine in stationary traffic.
- monitor the vehicle's fuel consumption.

Take-back of end-of-life vehicles

EU countries only:

Mercedes-Benz will take back your end-of-life vehicle for environmentally-friendly disposal in accordance with the European Union (EU) End-Of-Life Vehicles Directive.

A network of vehicle take-back points and dismantlers has been established for you to return your vehicle. You can leave it at any of these points free of charge. This makes an important contribution to closing the recycling circle and conserving resources.

For further information about the recycling and disposal of end-of-life vehicles, and the take-back conditions, please visit the national Mercedes-Benz website for your country.

Genuine Mercedes-Benz parts

Environmental note

Daimler AG also supplies reconditioned assemblies and parts which are of the same quality as new parts. For these, the same warranty applies as for new parts.

! Airbags and seat belt tensioners, as well as control units and sensors for these restraint systems, may be installed in the following areas of your vehicle:

- doors
- door pillars
- door sills
- seats
- dashboard
- instrument cluster
- centre console

Do not install accessories such as audio systems in these areas. Do not carry out repairs or welding. You could impair the operating efficiency of the restraint systems.

Have accessories retrofitted at a qualified specialist workshop.

You could jeopardise the operating safety of your vehicle if you use parts, tyres and wheels as well as accessories relevant to safety that have not been approved by Mercedes-Benz. This could lead to malfunctions in safety-relevant systems, e.g. the brake system. Use only genuine Mercedes-Benz parts or parts of equal quality. Use only tyres, wheels and accessories that have been specifically approved for your vehicle.

Mercedes-Benz tests genuine parts and conversion parts and accessories that have been specifically approved for your vehicle for their reliability, safety and suitability. Despite ongoing market research, Mercedes-Benz is unable to assess other parts. Mercedes-Benz therefore accepts no responsibility for the use of such parts in Mercedes-Benz vehicles, even if they have been officially approved or independently approved by a testing centre.

In Germany, certain parts are officially approved for installation or modification only if they comply with legal requirements. This also applies to some other countries. All genuine Mercedes-Benz parts meet the approval requirements. The use of non-approved parts may invalidate the vehicle's general operating permit.

This is the case:

- if they cause a change of the vehicle type from that for which the vehicle's general operating permit was granted
- if other road users could be endangered
- if the emission or noise levels are adversely affected

Always specify the vehicle identification number (VIN) (> page 333) when ordering genuine Mercedes-Benz parts.

Owner's Manual

Vehicle equipment

i This Owner's Manual describes all models and all standard and optional equipment available for your vehicle at the time of publication of the Owner's Manual. Country-specific differences are possible. Note that your vehicle may not be fitted with all features described. This is also the case for systems and functions relevant to safety. Therefore,

the equipment on your vehicle may differ from that in the descriptions and illustrations.

The original purchase contract documentation for your vehicle contains a list of all the systems in your vehicle.

Should you have any questions concerning equipment and operation, please consult a Mercedes-Benz Service Centre.

The Owner's Manual and Service Booklet are important documents and should be kept in the vehicle.

Operating safety

Declarations of conformity

Wireless vehicle components

The following information applies to all components of the vehicle and the information systems and communication devices integrated in the vehicle that receive and/or transmit radio waves.

The components of this vehicle that receive and/or transmit radio waves are compliant with the basic requirements and all other relevant conditions of Directive 2014/53/EC. Further information can be obtained at a qualified specialist workshop.

Electromagnetic compatibility

The electromagnetic compatibility of the vehicle components has been checked and certified according to the currently valid version of Regulation ECE-R 10.

Jack

Copy and translation of the original declaration of conformity:

EC declaration of conformity

1. The signatory, as a representative
Manufacturer:
BRANO a.s.
74741 Hradec nad Moravicí, Opavská 1000,
Czech Republic
ID no.: 64-387-5933
VAT ID no.: CZ64-387-5933

declares, as our sole responsibility, that the product:

2. Description:

a) Jack

Model, number:

A) A 164 580 02 18, A 166 580 01 18

B) A 240 580 00 18

C) A 639 580 02 18

Year of manufacture: 2015

Fulfils all relevant conditions

Directive no. 2006/42/EC

b) Description and purpose of use:

The jack is intended only for raising the specified vehicle according to the operating instructions affixed to the jack.

3. Reference data of the harmonised standards or specifications

A) ISO 4063, EN ISO 14341-A, DBL 7382.20, MBN 10435, AS 2693

B) ISO 4063, ISO 14341-A, DBL 7392.10, MBN 10435

C) DBL 7392.10, DBL 8230.10

Technical documentation for the product is held by the manufacturer. Authorised representative for the compilation of the technical documentation: director of the technical department at Brano a.s.

4. Hradec nad Moravicí

City

5. 05.05.2015

Date

Signed by:

Director of Quality

TIREFIT kit

Copy and translation of the original declaration of conformity:

EC declaration of conformity

In accordance with EC directive 2006/42/EC

We hereby declare that the product

1. Product designation: Daimler electric air pump

2. Model designation: 0852, DT/UW 2000 16

3. MB part no.: A 000 583 22 02

complies with the following relevant regulations:

EMC 72/245/EC

Applied harmonised standards, in particular: ISO 7637-2: 2004

4. a) Manufacturer: Dunlop Tech GmbH

b) Address: Birkenhainerstrasse 77, 63450 Hanau, Germany

c) Authorised representative: IMS department

d) Date: June 2011

e) Signature: IMS-AM, IMS-AE-L

Diagnostics connection

The diagnostics connection is used for connecting diagnostic equipment at a qualified specialist workshop.

WARNING

If you connect equipment to a diagnostics connection in the vehicle, it may affect the operation of vehicle systems. As a result, the operating safety of the vehicle could be affected. There is a risk of an accident.

Only connect equipment to a diagnostics connection in the vehicle, which is approved for your vehicle by Mercedes-Benz.

WARNING

Objects in the driver's footwell may restrict the clearance around the pedals or block a depressed pedal. This jeopardises the operating and road safety of the vehicle. There is a risk of an accident.

Stow all objects securely in the vehicle so that they do not get into the driver's footwell.

Always fit the floor mats securely and as prescribed in order to ensure that there is always sufficient room for the pedals. Do not use loose floor mats and do not place several floor mats on top of one another.

 If the engine is switched off and equipment on the diagnostics connection is used, the starter battery may discharge.

Connecting equipment to the diagnostics connection can lead to emissions monitoring information being reset, for example. This may lead to the vehicle failing to meet the requirements of

the next emissions test during the main inspection.

Qualified specialist workshop

A qualified specialist workshop has the necessary special skills, tools and qualifications to correctly carry out any necessary work on your vehicle. This particularly applies to work relevant to safety.

Observe the notes in the Service Booklet.

Always have the following work carried out at a qualified specialist workshop:

- work relevant to safety
- service and maintenance work
- repair work
- modifications, installations and conversions
- work on electronic components

Mercedes-Benz recommends that you use a Mercedes-Benz Service Centre.

Vehicle registration

Mercedes-Benz may ask its Service Centres to carry out technical inspections on certain vehicles. The quality or safety of the vehicle is improved as a result of the inspection.

Mercedes-Benz can only inform you about vehicle checks if it has your registration data.

It is possible that your vehicle has not yet been registered in your name in the following cases:

- if your vehicle was not purchased at an authorised specialist dealer
- if your vehicle has not yet been inspected at a Mercedes-Benz Service Centre

It is advisable to register your vehicle with a Mercedes-Benz Service Centre.

Inform Mercedes-Benz as soon as possible about any change in address or vehicle ownership. You can do this at a Mercedes-Benz Service Centre, for example.

Correct use

If you remove any warning stickers, you or others could fail to recognise certain dangers. Leave warning stickers in position.

Observe the following information when driving your vehicle:

- the safety notes in this manual
- technical data for the vehicle
- traffic rules and regulations
- laws and safety standards pertaining to motor vehicles

Implied warranty

I Observe the notes in this Owner's Manual regarding the correct operation of your vehicle and possible damage to the vehicle. Damage to the vehicle which is caused by violation of these notes is not covered by the Mercedes-Benz implied warranty or the new or used-vehicle warranty.

QR code for rescue card

The QR code is secured in the fuel filler flap and on the opposite side on the B-pillar. In the event of an accident, rescue services can use the QR code to quickly find the appropriate rescue card for your vehicle. The current rescue card contains, in a compact form, the most important information about your vehicle, e.g. the routing of the electric cables.

You can find more information under www.mercedes-benz.de/qrcode.

Data stored in the vehicle

Data storage in the vehicle

Your vehicle is fitted with electronic control units. Some of them are essential for ensuring that your vehicle runs safely, while others assist you with driving (driver assistance systems). Your vehicle also offers a range of comfort and entertainment functions, which are also enabled by means of electronic control units.

Electronic control units contain data storage systems that can temporarily or permanently save technical information concerning the vehicle's condition, component stress and maintenance requirements, as well as technical events and faults.

This information generally documents the condition of a component, a module, a system or the surroundings, for example:

- operating states of system components (e.g. fill levels, battery status, tyre pressure)
- status messages concerning the vehicle or its individual components (e.g. number of wheel revolutions/speed, deceleration in movement, lateral acceleration, display of fastened seat belts)
- malfunctions and defects in important system components (e.g. lights, brakes)
- information on events leading to vehicle damage
- system responses in special driving situations (e.g. airbag deployment, intervention of stability control systems)
- environmental conditions (e.g. temperature, rain and light sensors)

In addition to performing the actual control unit function, these data are used by manufacturers to detect and rectify faults and to optimise vehicle functions. Most of these data are stored in volatile memory and processed only in the vehicle itself. Only a small part of the data are stored in event or fault memories.

When you use services, the technical data from the vehicle can be read out by service network employees (e.g. workshops, manufacturers) or third parties (e.g. breakdown services). Services can include repair services, maintenance processes, warranty cases and quality assurance measures. The data is read out via the connection for OBD (diagnostics connection) in the vehicle, which is required by law. The relevant offices in the service network or third parties collect, process and use the data. These data document the vehicle's technical states, are used to help in finding faults and improving quality and are sent to the manufacturer where necessary. In addition, the manufacturer is subject to product liability. The manufacturer needs technical data from vehicles for this purpose.

Fault memories in the vehicle can be reset by a service outlet during repair or service work.

You can incorporate data into the vehicle's comfort and infotainment functions yourself as part of the selected equipment.

These include, for example:

- multimedia data such as music, films or photos for playback in an integrated multimedia system
- address book data for use in conjunction with an integrated hands-free system or an integrated navigation system
- navigation destinations that have been entered
- data about using internet services

This data can be saved locally in the vehicle or located on a device that you have connected to the vehicle (e.g. smartphone, USB memory stick or MP3 player). If these data are saved in the vehicle, you can delete them at any time. These data are sent to third parties only at your request, particularly when you use online services in accordance with the settings that you have selected.

You can save convenience settings/personalised settings in the vehicle and modify them at any time.

Depending on the piece of equipment in question, these can include:

- settings for the seat and steering wheel positions
- suspension and climate control settings
- customisations such as interior lighting

If your vehicle is equipped appropriately, you can connect your smartphone or another mobile end device to the vehicle. You can control this by means of the control elements integrated in the vehicle. The smartphone's picture and sound can be output via the multimedia system. Specific items of information are also sent to your smartphone.

Depending on the type of integration, this can include:

- general vehicle information
- position data

This allows the use of selected smartphone apps, such as navigation or music player apps. There is no additional interaction between the smartphone and the vehicle, particularly active access to vehicle data. The type of additional data processing is determined by the provider of the app being used. Whether you can configure settings for it and, if so, which ones, depends on the app and your smartphone's operating system.

Online services

Wireless network connection

If your vehicle has a wireless network connection, data can be exchanged between your vehicle and other systems. The wireless network connection is made possible by the vehicle's own transmitter and receiver or by mobile end devices that you have brought into the vehicle (e.g. smartphones). This wireless network connection enables online functions to be used. These include online services and applications/apps provided by the manufacturer or other providers.

Services provided by the manufacturer

In the case of the manufacturer's online services, the manufacturer describes the functions in a suitable place (e.g. operating instructions, manufacturer's website) and provides the associated information subject to data protection legislation. Personal data can be used to provide online services. The data exchange for this takes place via a secure connection, e.g. with the manufacturer's IT systems intended for the purpose. Collecting, processing and using personal data beyond the provision of services are permitted only on the basis of a statutory permit or declaration of consent.

You can usually activate and deactivate the services and functions (some of which are subject to a fee). In some cases, this also applies to the vehicle's entire data connection. There are exceptions to this; in particular, legally required functions and services such as the "eCall" traffic emergency call system.

Services from third parties

If it is possible to use online services from other providers, these services are the responsibility of the provider in question and subject to that provider's data protection conditions and terms of use. The manufacturer has no influence over the data exchanged in such cases.

For this reason, please ask the service provider for information about the type, extent and purpose of the collection and use of personal data when services are provided by third parties.

Copyright information

General information

Information on licences for free and open-source software used in your vehicle and its electronic components is available on the following website:

<http://www.mercedes-benz.com/opensource>

Cockpit

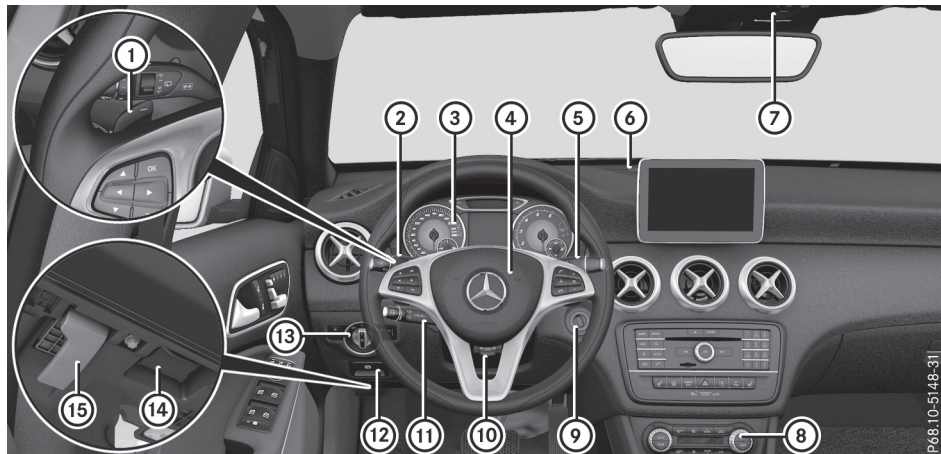

	Function	Page
①	Steering wheel gearshift paddles	152
②	Combination switch	109
③	Instrument cluster	33
④	Horn	
⑤	DIRECT SELECT lever	146
⑥	Parking Assist PARKTRONIC warning display	180
⑦	Overhead control panel	39

	Function	Page
⑧	Climate control systems	119
⑨	Ignition lock	135
⑩	Adjusts the steering wheel	102
⑪	Cruise control lever	164
⑫	Electric parking brake	158
⑬	Light switch	107
⑭	Diagnostics connection	27
⑮	Opens the bonnet	285

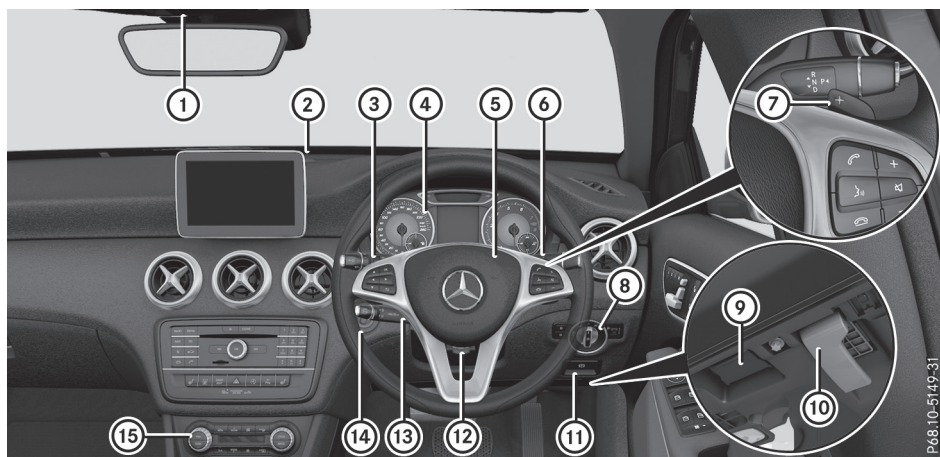

P68.10-0149-31

	Function	Page
①	Overhead control panel	39
②	Parking Assist PARKTRONIC warning display	180
③	Combination switch	109
④	Instrument cluster	33
⑤	Horn	
⑥	DIRECT SELECT lever	146
⑦	Steering wheel gearshift paddles	152

	Function	Page
⑧	Light switch	107
⑨	Opens the bonnet	285
⑩	Diagnostics connection	27
⑪	Electric parking brake	158
⑫	Ignition lock	135
⑬	Adjusts the steering wheel	102
⑭	Cruise control lever	164
⑮	Climate control systems	119

Instrument cluster

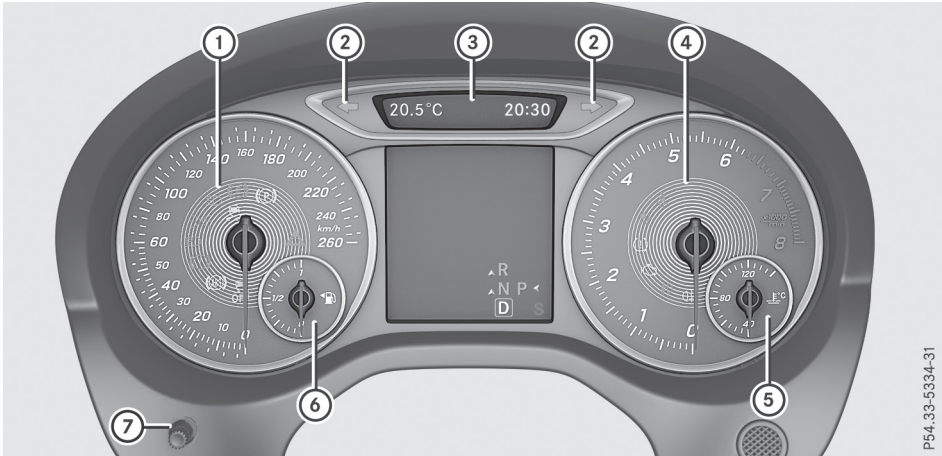

P54.33-5334-31

	Function	Page		Function	Page
①	Speedometer with segments Indicator and warning lamps:	201		Indicator and warning lamps:	
	Dipped-beam headlamps	108		Restraint system	41
	Side lamps	108		Seat belt not fastened	249
	Main-beam headlamps	109		Diesel engine: preglow	137
	ESP®	253		SPORT handling mode (Mercedes-AMG vehicles)	254
	Electric parking brake applied (red)	256		Rear foglamp	108
	Electric parking brake (yellow)	256		Engine diagnostics	256
	Distance warning	259		Tyre pressure monitor	260
	ESP® OFF	253	⑤	Coolant temperature display	202
	ABS malfunctioning	251		Indicator and warning lamp:	
	Brakes	250		Coolant too hot/cold	257
②	Turn signals	109	⑥	Fuel gauge display	
③	Multifunction display	204		Indicator and warning lamp:	
④	Rev counter	201		Reserve fuel	256
			⑦	Instrument cluster lighting	201

Multifunction steering wheel



P46.10-3582-31

	Function	Page
①	Multifunction display	204
②	Multimedia system display	
③	Rejects or ends a call Makes or accepts a call Further telephone functions Adjusts the volume Mute Switches on voice-operated control for navigation or LINGUATRONIC	208

	Function	Page
④	Opens the menu list Selects a menu Confirms the selection Back Operates the on-board computer Switches on voice-operated control for navigation or LINGUATRONIC	202

- i** You can find further information in vehicles with an Audio 20 multimedia system:
- on the multimedia system in the Digital Owner's Manual
 - on voice-operated control of the navigation system in the manufacturer's operating instructions

- i** You can find further information in vehicles with a COMAND Online multimedia system:
- on the multimedia system in the Digital Owner's Manual
 - on the DVD changer or single DVD drive in the Digital Owner's Manual
 - on LINGUATRONIC in the separate operating instructions

Centre console

Centre console, upper section

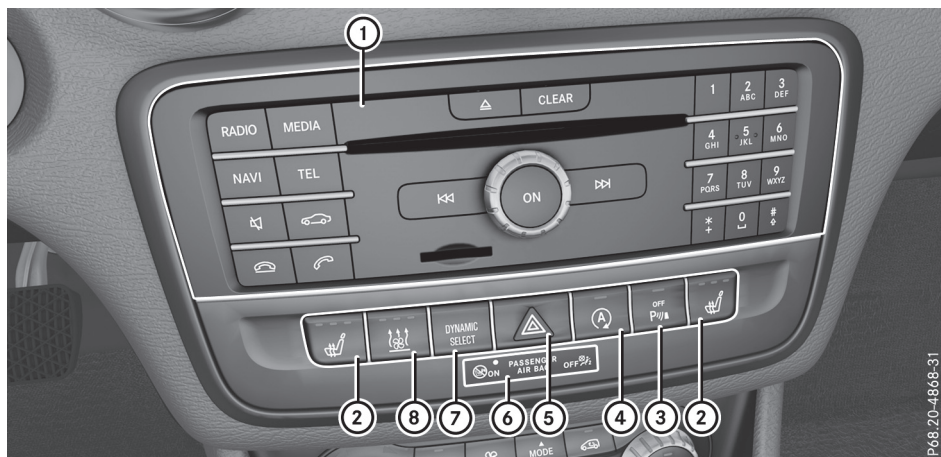

P68.20-4868-31

	Function	Page		Function	Page
①	Multimedia system (see the Digital Owner's Manual)		④	ECO start/stop function	139
②	Seat heating Mercedes-AMG vehicles: AMG RIDE CONTROL (left side)	101 177	⑤	Hazard warning lamps	109
	Mercedes-AMG vehicles: adjusts the exhaust flap of the AMG performance exhaust system (right side)	141	⑥	PASSENGER AIRBAG indicator lamps	41
③	Parking Assist PARKTRONIC	180	⑦	DYNAMIC SELECT button Mercedes-AMG vehicles: ESP®	143 71
			⑧	Auxiliary heating	128

Centre console, lower section

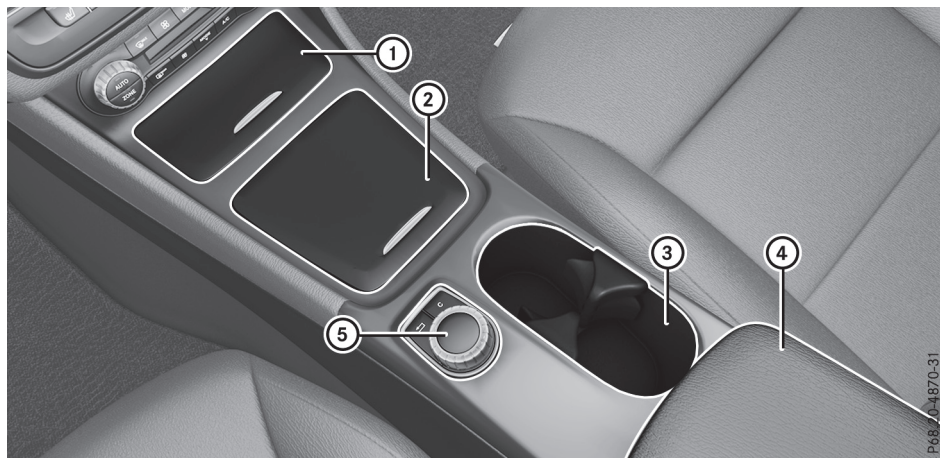

	Function	Page
①	Ashtray Cigarette lighter Power socket Stowage space	279 280 280 271
②	Stowage space	271
③	Cup holder	277

	Function	Page
④	Stowage space with media interface	271
⑤	Multimedia system controller (see the Digital Owner's Manual)	

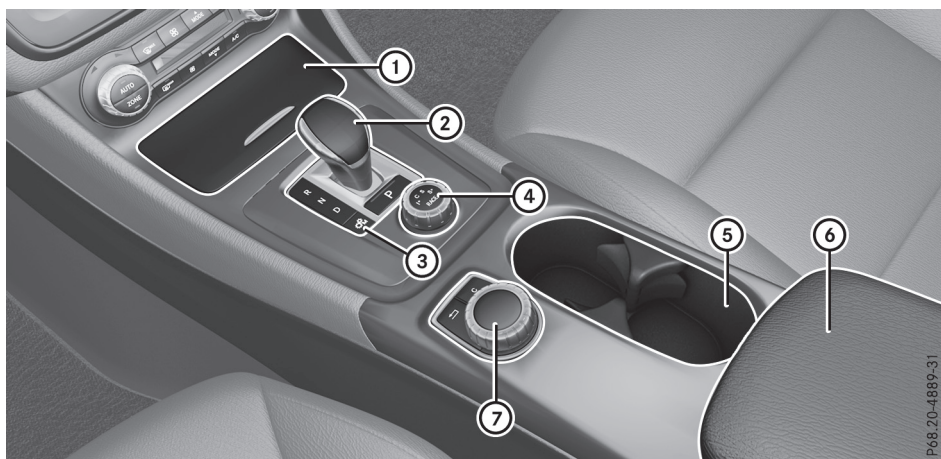

P68.20-4889-31









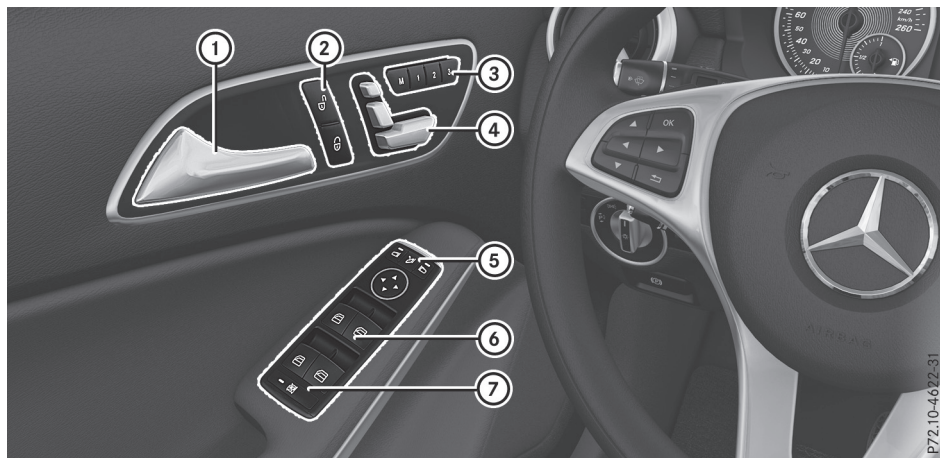

i Mercedes-AMG vehicles



	Function	Page
①	Ashtray Cigarette lighter Power socket Stowage space	279 280 280 271
②	Selector lever	147
③	Manual gearshifting (permanent setting)	152

	Function	Page
④	DYNAMIC SELECT controller	143
⑤	Cup holder	277
⑥	Stowage space with media interface	271
⑦	Multimedia system controller (see the Digital Owner's Manual)	

Door control panel







	Function	Page
①	Opens the door	83
②	  Unlocks/locks the vehicle	84
③	    Saves the seat and exterior mirror settings	106
④	Adjusts the seats electrically	99
⑤	    Adjusts and folds the exterior mirrors in/out electrically	103

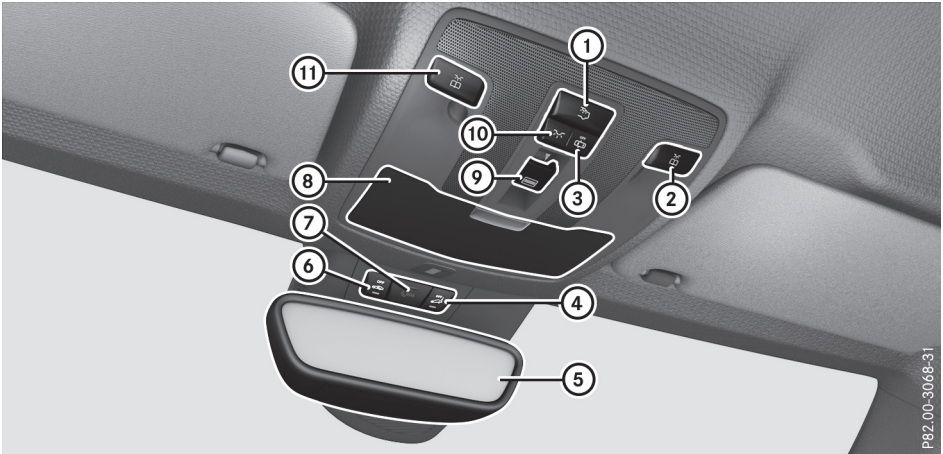



	Function	Page
⑥	 Opens/closes the side windows	89
⑦	 Activates/deactivates the override feature for the side windows in the rear compartment	65

Overhead control panel



PBZ.00-3068-31

	Function	Page
①	 Switches the rear interior lighting on/off	111
②	 Switches the right-hand reading lamp on/off	111
③	 Switches the front interior lighting/automatic interior lighting control off	111
④	 Primes/deactivates tow-away protection	74
⑤	Rear-view mirror	105
⑥	 Primes/deactivates the interior motion sensor	74

	Function	Page
⑦	 SOS button (Mercedes-Benz emergency call system), only available for certain countries	281
⑧	Spectacles compartment	272
⑨	 Opens/closes the panorama sliding sunroof with roller sunblinds	93
⑩	 Switches the front interior lighting on	111
⑪	 Switches the left-hand reading lamp on/off	111

Panic alarm



- ▶ **To activate:** press and hold **PANIC** button ① for approx. one second. A visual and audible alarm is triggered if the alarm system is primed.
 - ▶ **To deactivate:** press **PANIC** button ① again.
- or
- ▶ Insert the key into the ignition lock.
- or, on vehicles with KEYLESS-GO start function or KEYLESS-GO:
- ▶ Press the Start/Stop button.
The key must be in the vehicle.

The panic alarm function is only available in certain countries.

Occupant safety

Introduction to the restraint system

The restraint system can reduce the risk of vehicle occupants coming into contact with parts of the vehicle's interior in the event of an accident. The restraint system can also reduce the forces to which vehicle occupants are subjected during an accident.

The restraint system includes the:

- seat belt system
- airbags
- child restraint system
- child seat securing system

The components of the restraint system work in conjunction with each other. They can only offer protection if all vehicle occupants always:

- have the seat belt correctly fastened (▷ page 43)
- have the seat and head restraint adjusted properly (▷ page 97)

As the driver, you must also make sure that the steering wheel is also adjusted properly. Observe the information on the correct driver's seat position (▷ page 97).

In addition, you must make sure that the airbags can inflate properly if they are deployed (▷ page 45).

An airbag supplements a correctly worn seat belt. As an additional safety device, the airbag increases the level of protection for vehicle occupants in the event of an accident. The airbags are not deployed, for example, in the event of an accident in which sufficient protection is offered by the seat belt. In addition, only those airbags, which in the applicable accident situations offer additional protection, are deployed in the event of an accident. However, the seat belt and airbag generally do not protect against objects penetrating the vehicle from the outside.

Information on how the restraint system operates can be found under "Deployment of belt tensioners and airbags" (▷ page 52).

See "Children in the vehicle" for information on children travelling with you in the vehicle as well as on child restraint systems (▷ page 55).

Important safety notes

WARNING

If the restraint system is modified, it may no longer work as intended. The restraint system may then not perform its intended protective function by failing in an accident or triggering unexpectedly, for example. There is an increased risk of injury, possibly even fatal.

Never modify parts of the restraint system. Do not attempt to modify the wiring as well as electronic components or their software.

If it is necessary to adjust the vehicle to accommodate a person with disabilities, contact a qualified specialist workshop.

Mercedes-Benz recommends that you only use driving aids which have been approved specifically for your vehicle by Mercedes-Benz.

Restraint system warning lamp

The functions of the restraint system are checked after the ignition is switched on and at regular intervals while the engine is running. Therefore, malfunctions can be detected in good time.

The  restraint system warning lamp on the instrument cluster lights up when the ignition is switched on. It goes out no later than a few seconds after the vehicle is started. The components of the restraint system are in operational readiness.

A malfunction has occurred if the  restraint system warning lamp:

- does not light up after the ignition is switched on
- does not go out after a few seconds with the engine running
- lights up again while the engine is running

WARNING

If the restraint system is malfunctioning, restraint system components may be triggered unintentionally or may not deploy as intended during an accident. This may affect the seat belt tensioner or airbag, for example. This poses an increased risk of injury or even fatal injury.

Have the restraint system checked and repaired immediately at a qualified specialist workshop.

PASSENGER AIR BAG indicator lamp

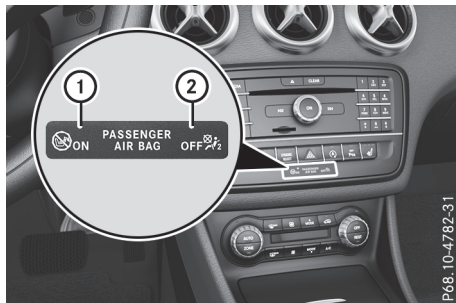

PASSENGER AIR BAG ON indicator lamp ① and PASSENGER AIR BAG OFF indicator lamp ② are part of the automatic deactivation system of the front-passenger front airbag.

The indicator lamps display the status of the front-passenger front airbag.

- PASSENGER AIR BAG ON lights up for 60 seconds, then both indicator lamps are off (PASSENGER AIR BAG ON and OFF): the front-passenger front airbag is able to deploy in the event of an accident.
- PASSENGER AIR BAG OFF lights up: the front-passenger front airbag is disabled. It will then not be deployed in the event of an accident.

If the PASSENGER AIR BAG ON indicator lamp is off, only the PASSENGER AIR BAG OFF indicator lamp shows the status of the front-passenger front airbag. The PASSENGER AIR BAG OFF indicator lamp may be lit continuously or be off.

Depending on the person in the front-passenger seat, the front-passenger front airbag must be either disabled or enabled; see the following points. You must make sure of this both before and during a journey.

- **Children in a rearward-facing child restraint system:** the PASSENGER AIR BAG OFF indicator lamp must be lit. The front-passenger front airbag is disabled. Make sure that you read the notes on the "Automatic front-passenger front airbag deactivation system" (▷ page 48) and on "Children in the vehicle" (▷ page 55).
- **Children in a forward-facing child restraint system:** depending on the installed child restraint system and the age and size of the child, the front-passenger front airbag is either disabled or enabled. Therefore, make sure that you read the notes on the "Automatic front-passenger front airbag deactivation system" (▷ page 48) and on "Children in the vehicle" (▷ page 55).

tion system" (▷ page 48) and on "Children in the vehicle" (▷ page 55).

- **All other persons:** the PASSENGER AIR BAG OFF indicator lamp must be off. The front-passenger front airbag is enabled. Depending on the build of the person on the front-passenger seat, the PASSENGER AIR BAG OFF indicator lamp may light up. The front-passenger front airbag is disabled. It will then not be deployed in the event of an accident. In this case, the front-passenger seat should not be used.

Make sure that you read the notes on the "Automatic front-passenger front airbag deactivation system" (▷ page 48) as well as on "Seat belts" (▷ page 42) and "Airbags" (▷ page 45). There, you can also find information on the correct seat position.

Seat belts

Introduction

A correctly fastened seat belt is the most effective means of restraining the movement of vehicle occupants in the event of a collision or if the vehicle overturns. It reduces the risk of vehicle occupants coming into contact with parts of the vehicle interior or being ejected from it. The seat belt also helps to keep the vehicle occupants in the best position in relation to the airbag being deployed.

The seat belt system consists of:

- seat belts
- belt tensioners for the front seat belts and the outer seat belts in the rear
- belt force limiters for the front seat belts and the outer seat belts in the rear

If the seat belt is pulled quickly or sharply from the belt outlet, the inertia reel locks. The belt strap cannot be pulled out any further.

The belt tensioner tightens the seat belt in the event of a collision so that it fits tightly across your body. However, it does not pull the vehicle occupants back in the direction of the seat backrest.

The belt tensioner also does not correct an incorrect seat position or correct the routing of a seat belt that is worn incorrectly.

When triggered, seat belt force limiters help to reduce the peak force exerted by the seat belt on the vehicle occupant.

The belt force limiters on the front seats are synchronised with the front airbags, which take on part of the deceleration force. This can reduce the forces to which the vehicle occupants are subjected during an accident.

- If the front-passenger seat is not occupied, do not engage the seat belt tongue in the buckle on the front-passenger seat. Otherwise, in the event of an accident the belt tensioner and the sidebag, in addition to other systems, may be triggered and have to be replaced.

Important safety notes

WARNING

If the seat belt is worn incorrectly, it cannot perform its intended protective function. Furthermore, an incorrectly worn seat belt can cause additional injuries, e.g. in the event of an accident, heavy braking or sudden changes of direction. There is an increased risk of injury, possibly even fatal.

Always ensure that all vehicle occupants have their seat belts fastened correctly and are sitting properly.

The components of the restraint system work in conjunction with each other. They can only offer protection if all vehicle occupants always:

- have the seat belt correctly fastened (▷ page 43)
- have the seat and head restraint adjusted properly (▷ page 97)

WARNING

The seat belt does not offer the intended level of protection if you have not moved the backrest to an almost vertical position. When braking or in the event of an accident, you could slide underneath the seat belt and sustain abdomen or neck injuries, for example. This poses an increased risk of injury or even fatal injury.

Adjust the seat properly before beginning your journey. Always ensure that the backrest is in an almost vertical position and that the shoulder section of your seatbelt is routed across the centre of your shoulder.

⚠ WARNING

Persons under 1.50 m tall cannot wear the seat belts correctly without an additional suitable restraint system. If the seat belt is worn incorrectly, it cannot perform its intended protective function. Furthermore, an incorrectly worn seat belt can cause additional injuries, e.g. in the event of an accident, heavy braking or sudden changes of direction. There is an increased risk of injury, possibly even fatal.

Always secure persons less than 1.50 m tall in additional suitable restraint systems.

If a child younger than twelve years old and under 1.50 m in height is travelling in the vehicle:

- always secure the child in a child restraint system suitable for this Mercedes-Benz vehicle. The child restraint system must be appropriate to the age, weight and size of the child
- be sure to observe the instructions and safety notes on the "Automatic front-passenger front airbag deactivation system" (▷ page 48)
- be sure to observe the instructions and safety notes on "Children in the vehicle" (▷ page 55) in addition to the manufacturer's operating and installation instructions for the child restraint system

⚠ WARNING

Seat belts cannot protect as intended, if:

- they are damaged, have been modified, are extremely dirty, bleached or dyed
- the seat belt buckle is damaged or extremely dirty
- modifications have been made to the belt tensioners, belt anchorages or inertia reels

Seat belts may sustain non-visible damage in an accident, e.g. due to glass splinters. Modified or damaged seat belts can tear or fail, for example in the event of an accident. Modified seat belt tensioners may be deployed unintentionally or not function as intended. There is an increased risk of injury, possibly even fatal.

Never modify seat belts, seat belt tensioners, seat belt anchorages and inertia reels. Ensure that seat belts are not damaged or worn and are clean. After an accident, have the seat belts checked immediately at a qualified specialist workshop.

Mercedes-Benz recommends that you only use seat belts that have been approved specifically for your vehicle by Mercedes-Benz. Otherwise, your vehicle's general operating permit could be invalidated.

Sports seat or AMG Performance seat: this seat is designed for the standard three-point seat belt. If you fit another multipoint seat belt, e.g. sport or racing seat belts, the restraint system cannot provide the best level of protection.

⚠ WARNING

If you feed seat belts through the opening in the seat backrest, the seat backrest may be damaged or may even break in the event of an accident. This poses an increased risk of injury or even fatal injury.

Only use the standard three-point seat belt. Never modify the seat belt system.

Correct seat belt use

Observe the safety notes on the seat belt (▷ page 42).

All vehicle occupants must be wearing the seat belt correctly before beginning the journey. Also make sure that all vehicle occupants are always wearing the seat belt correctly while the vehicle is in motion.

When fastening a seat belt, always make sure that:

- the seat belt buckle tongue is inserted only into the belt buckle belonging to that seat
- the seat belt is pulled tight across the body
Avoid wearing bulky clothing, e.g. a winter coat.
- the seat belt is not twisted
Only then can any forces that occur be distributed across the surface of the seat belt.
- the shoulder section of the belt is routed across the centre of the shoulder
The shoulder section of the seat belt should not touch your neck or be routed under your

arm or behind your back. If possible, adjust the seat belt to the appropriate height.

- the lap belt is taut and passes across the lap as low down as possible

The lap belt must always be routed across your hip joints and never across your abdomen. This applies particularly to pregnant women. If necessary, press the lap belt down into your hip joints and pull tight with the shoulder section of the belt.

- the seat belt is not routed across sharp, pointed or fragile objects

If you have such items located on or in your clothing, e.g. pens, keys or spectacles, store these in a suitable place.

- only one person is using a seat belt

Infants and children must never travel sitting on the lap of a vehicle occupant. In the event of an accident, they could be crushed between the vehicle occupant and seat belt.

- objects are never secured with a seat belt if the seat belt is also being used by one of the vehicle's occupants

Also ensure that no objects are placed between a person and the seat. e.g. a cushion.

Seat belts are intended only to secure and restrain vehicle occupants. Always observe the "Loading guidelines" for securing objects, luggage or loads (▷ page 271).

Fastening and adjusting the seat belts

Observe the safety notes on the seat belt (▷ page 42) and the information on the correct use of the seat belt (▷ page 43).

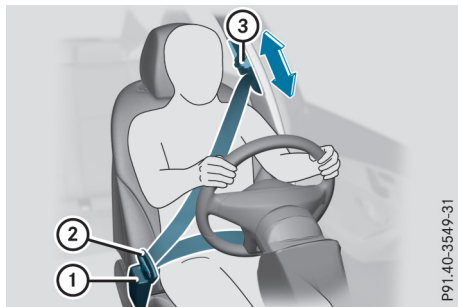

Basic illustration

- ▶ Adjust the seat (▷ page 97).
The seat backrest must be in an almost upright position.
- ▶ Pull the seat belt smoothly from the belt outlet.
- ▶ Engage seat belt tongue ② in belt buckle ①.
The seat belt on the driver's seat and the front-passenger seat may be tightened automatically; see "Belt adjustment" (▷ page 44).
- ▶ If necessary, pull upwards on the seat belt in front of your chest so that the belt sits tightly across your body.

The shoulder section of the seat belt must always be routed across the centre of the shoulder. Adjust the belt outlet if necessary.

- ▶ **To raise:** slide the belt outlet upwards.
The belt outlet will engage in various positions.
- ▶ **To lower:** hold belt outlet release ③ and slide the belt outlet downwards.
- ▶ Let go of belt outlet release ③ in the desired position and make sure that the belt outlet engages.

Releasing seat belts

- Make sure that the seat belt is fully rolled up. Otherwise, the seat belt or belt tongue will be trapped in the door or in the seat mechanism. This could damage the door, the door trim panel and the seat belt. Damaged seat belts can no longer fulfil their protective function and must be replaced. Visit a qualified specialist workshop.
- ▶ Press release button in belt buckle, hold belt tongue firmly and guide the seat belt back.

Belt adjustment

Seat-belt adjustment is an integral part of the PRE-SAFE® convenience function. With this function, the driver's and co-driver's seat belts are adjusted to the upper body of the vehicle occupant.

The belt strap is tightened slightly when:

- the belt tongue is engaged in the buckle and
- the ignition is switched on

The seat belt adjustment will apply a certain tightening force if any slack is detected between the vehicle occupant and the seat belt. Do not

hold on to the seat belt tightly while it is adjusting.

You can switch the seat belt adjustment on and off in the on-board computer (▷ page 214).

Seat belt warning for the driver and front-passenger

The  seat belt warning lamp in the instrument cluster is a reminder that all vehicle occupants must wear their seat belts. It may light up continuously or flash. In addition, a warning tone may sound.

The  seat belt warning lamp goes out and the warning tone ceases when the driver and the front passenger have fastened their seat belts.

Rear seat belts status indicator



P54.33-4260-31

The seat belts on the left and centre rear seats, when viewed in the direction of travel, are not fastened. (Example)

The rear seat belt status indicator is only available for certain countries.

The rear seat belt status indicator informs you which rear seat belt is not fastened.

Hiding the rear seat belt status indicator immediately (▷ page 218).

Airbags

Introduction

The installation location of an airbag is identified by the AIRBAG symbol.

An airbag supplements a correctly worn seat belt. It is not a replacement for the seat belt. The airbag offers additional protection in corresponding accident situations.

Not all airbags are deployed in an accident. The different airbag systems work independently of each other (▷ page 52).

However, no system available today can completely eliminate injuries and fatalities.

It is also not possible to completely rule out a risk of injury caused by an airbag due to the speed at which the airbag must be deployed.

Important safety notes

WARNING

If you deviate from the correct seat position, the airbag cannot perform its intended protective function and can even cause additional injuries when deployed. There is an increased risk of serious or even fatal injuries.

In order to avoid such risks, always ensure that all vehicle occupants:

- fasten their seatbelts correctly, including pregnant women
- are seated correctly and maintain the furthest possible distance from the airbags
- observe the following notes

Always ensure that there are no objects located between the airbag and the vehicle occupant.

- Adjust the seats properly before beginning your journey. Always make sure that the seat is in an almost upright position. The centre of the head restraint must support the head at about eye level.
- Move the driver's and front-passenger seats as far back as possible. The driver's seat position must allow the vehicle to be driven safely.
- Hold the steering wheel only by the rim. This allows the airbag to be fully deployed.
- Always lean against the backrest while driving. Do not lean forwards or lean against the door or side window. You may otherwise be in the deployment area of the airbags.
- Always keep your feet in the footwell in front of the seat. Do not put your feet on the dashboard, for example. Your feet may otherwise be in the deployment area of the airbag.
- Always secure persons less than 1.50 m tall in suitable restraint systems. Up to this height, the seat belt cannot be worn correctly.

If a child is travelling in your vehicle, also observe the following notes:

- Always secure children under twelve years of age and less than 1.50 m tall in suitable child restraint systems.
- Child restraint systems should preferably be fitted to the rear seats.
- Secure a child to the front-passenger seat only when the front-passenger front airbag is disabled, and then only in a rearward-facing child restraint system. If the PASSENGER AIR BAG OFF indicator lamp is permanently lit, the front-passenger front airbag is disabled (▷ page 41).
- Be sure to observe the instructions and safety notes on the "Automatic front-passenger front airbag deactivation system" (▷ page 48) and on "Children in the vehicle" (▷ page 55) in addition to the manufacturer's operating and installation instructions for the child restraint system.

Objects in the vehicle interior may prevent the airbag from functioning correctly. Before starting your journey and to avoid risks resulting from the speed of the airbag as it deploys, make sure that:

- there are no people, animals or objects between the vehicle occupants and an airbag
- there are no objects between the seat, door and B-pillar
- there are no hard objects, e.g. coat hangers, hanging on the grab handles or coat hooks
- no accessories, such as cup holders, are attached to the vehicle within the deployment area of an airbag, e.g. to doors, side windows, rear side trim or side walls
- no heavy, sharp-edged or fragile objects are in the pockets of your clothing. Store such objects in a suitable place.

WARNING

If you modify an airbag cover or affix objects such as stickers to it, the airbag can no longer function correctly. There is an increased risk of injury.

Never modify an airbag cover or affix objects to it.

WARNING

Sensors to control the airbags are located in the doors. Modifications or work not per-

formed correctly to the doors or door paneling, as well as damaged doors, can lead to the function of the sensors being impaired. The airbags might therefore not function properly any more. Consequently, the airbags cannot protect vehicle occupants as they are designed to do. This poses an increased risk of injury.

Never modify the doors or parts of the doors. Always have work on the doors or door paneling carried out at a qualified specialist workshop.

Front airbags

- ❗ Do not place heavy objects on the front-passenger seat. This could cause the system to identify the seat as being occupied. In the event of an accident, the restraint systems on the front-passenger side may be triggered and have to be replaced.

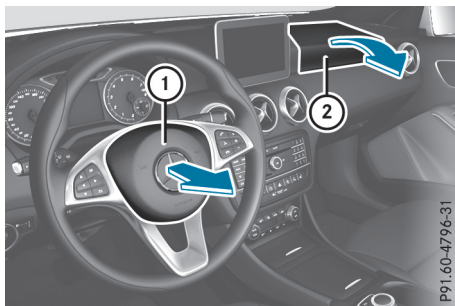

Driver's airbag ① deploys in front of the steering wheel. Front-passenger front airbag ② deploys in front of and above the glove compartment.

When deployed, the front airbags offer additional head and thorax protection for the occupants in the front seats.

The PASSENGER AIR BAG OFF indicator lamp informs you about the status of the front-passenger front airbag (▷ page 41).

The front-passenger front airbag will deploy only if:

- the automatic front-passenger front airbag deactivation system has detected that the front-passenger seat is occupied

(▷ page 48). The PASSENGER AIR BAG OFF indicator lamp is not lit (▷ page 48)

- the restraint system control unit predicts a high accident severity

Driver's kneebag



Driver's kneebag ① deploys under the steering column. The driver's kneebag is triggered together with the front airbags.

The driver's kneebag offers additional thigh, knee and lower leg protection for the occupant in the driver's seat.

- ① The driver's kneebag is only available in certain countries.

Sidebags

WARNING

Unsuitable seat covers may obstruct or even prevent deployment of the airbags integrated into the seats. The airbags may then fail to protect the vehicle occupants as intended. Operation of the automatic co-driver's front airbag deactivation system may also be impaired. There is an increased risk of injury, possibly even fatal.

Use only seat covers which have been specifically approved for the respective seat by Mercedes-Benz.

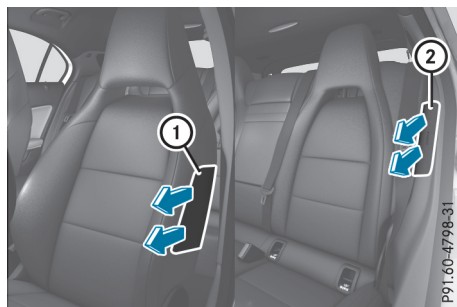

Front sidebags ① and rear sidebags ② deploy next to the outer bolster of the seat backrest.

When deployed, the sidebag offers additional thorax protection. It also offers additional pelvis protection for occupants in the front seats. However, it does not protect the:

- head
- neck
- arms

When the restraint system control unit detects a side impact, the sidebag is deployed on the side on which the impact occurs.

Vehicles with the automatic front-passenger front airbag deactivation system: the sidebag on the front-passenger side deploys under the following conditions:

- an occupant is detected in the front-passenger seat or
- the seat belt buckle tongue is engaged in the belt buckle of the front-passenger seat

If the belt tongue is engaged in the belt buckle, the sidebag on the front-passenger side deploys if an appropriate accident situation occurs. In this case, deployment is independent of whether the front-passenger seat is occupied or not.

Windowbags

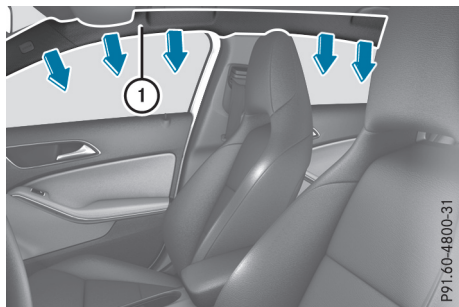

Windowbags ① are integrated in the side of the roof frame and deploy in the area from the A-pillar to the C-pillar.

When deployed, the windowbag enhances the level of protection for the head. However, it does not protect the chest or arms.

When the restraint system control unit detects a side impact, the windowbag is deployed on the side on which the impact occurs.

If the system determines that it can offer additional protection to that provided by the seat belt, a windowbag may be deployed in other accident situations (▷ page 52).

Automatic front-passenger front airbag deactivation system

Introduction

In order to recognise a child restraint system on the front-passenger seat, the automatic front-passenger front airbag deactivation system categorises the person in the front-passenger seat. Depending on that result, the front-passenger front airbag is either enabled or disabled. If a rearward-facing child restraint system is fitted to the front-passenger seat, the PASSENGER AIR BAG OFF indicator lamp must light up after the system self-test and remain lit. The front-passenger front airbag is disabled.

The system does not disable:

- the sidebag
- the windowbag
- the seat belt tensioner

Make sure that your vehicle is equipped with the automatic front-passenger front airbag deactivation system (▷ page 58). If this is not the

case, always install a child restraint system on a suitable rear seat (▷ page 59).

If it is absolutely necessary to install a child restraint system on the front-passenger seat, be sure to observe the correct positioning of the child restraint system. Never place objects under or behind the child restraint system, e.g. a cushion. Fully retract the seat cushion length. The entire base of the child restraint system must always rest on the seat cushion of the front-passenger seat. The backrest of a forward-facing child restraint system must, as far as possible, rest flat against the backrest of the front-passenger seat. The child restraint system must not touch the roof or be put under strain by the head restraint. Adjust the angle of the seat backrest and the head restraint position accordingly. Only then is the correct function of the automatic front-passenger front airbag deactivation system guaranteed. Always observe the information on suitable positioning of the child restraint system (▷ page 59) in addition to the child restraint system manufacturer's installation instructions.

Operation of automatic front-passenger airbag deactivation system

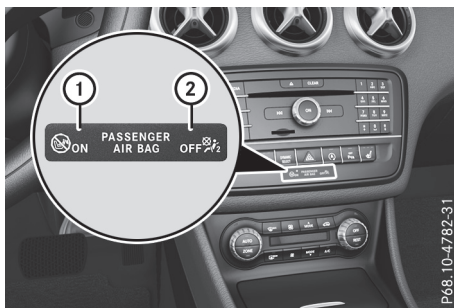

- ① PASSENGER AIR BAG ON indicator lamp
- ② PASSENGER AIR BAG OFF indicator lamp

The indicator lamps inform you whether the front-passenger front airbag is disabled or enabled.

- ▶ Press the Start/Stop button once or twice, or turn the key to position ① or ② in the ignition lock.

The system carries out a self-diagnosis.

The PASSENGER AIR BAG OFF and PASSENGER AIR BAG ON indicator lamps must light up simultaneously for approximately six seconds.

The indicator lamps display the status of the front-passenger front airbag:

- **PASSENGER AIR BAG ON** lights up for 60 seconds, then both indicator lamps are off (**PASSENGER AIR BAG ON** and **OFF**): the front-passenger front airbag is able to deploy in the event of an accident.
- **PASSENGER AIR BAG OFF** lights up: the front-passenger front airbag is disabled. It will then not be deployed in the event of an accident.

If the **PASSENGER AIR BAG ON** indicator lamp is off, only the **PASSENGER AIR BAG OFF** indicator lamp shows the status of the front-passenger front airbag. The **PASSENGER AIR BAG OFF** indicator lamp may be lit continuously or be off.

If the status of the front-passenger front airbag changes while the vehicle is in motion, an airbag display message appears on the instrument cluster (▷ page 228). When the front-passenger seat is occupied, always pay attention to the **PASSENGER AIR BAG OFF** indicator lamp. Be aware of the status of the front-passenger front airbag both before and during the journey.

If a person sits in the front-passenger seat, they must be:

- seated with the seat belt fastened correctly
- in an almost upright position with their back against the seat backrest
- with their feet resting on the floor, if possible

If the front passenger does not observe these conditions, the automatic front-passenger front airbag deactivation system may be influenced, e.g. because the front passenger:

- transfers their weight by supporting themselves on a vehicle armrest
- sits in such a way that their weight is raised from the seat cushion

The front-passenger front airbag may be disabled by mistake as a result of these or similar actions. In this case, the **PASSENGER AIR BAG OFF** indicator lamp lights up permanently. The front-passenger front airbag then does not deploy during an accident.

WARNING

If the **PASSENGER AIRBAG OFF** indicator lamp is lit, the front-passenger front airbag is disabled. It will not be deployed in the event of an accident and cannot perform its intended protective function. A person in the front-passenger seat could then, for example, come

into contact with the vehicle's interior, especially if the person is sitting too close to the dashboard. This poses an increased risk of injury or even fatal injury.

When the front-passenger seat is occupied, always make sure that:

- the classification of the person in the front-passenger seat is correct and that the front-passenger front airbag is enabled or disabled in accordance with the person in the front-passenger seat.
- the front-passenger seat has been moved back as far back as possible.
- the person is seated correctly.

Make sure, both before and during the journey, that the status of the front-passenger front airbag is correct.

WARNING

If you secure a child in a rearward-facing child restraint system on the front-passenger seat and the **PASSENGER AIR BAG OFF** indicator lamp is off, the front-passenger front airbag can deploy in the event of an accident. The child could be struck by the airbag. This poses an increased risk of injury or even fatal injury.

Make sure that the front-passenger front airbag has been disabled. The **PASSENGER AIR BAG OFF** indicator lamp must be lit.

NEVER use a rearward-facing child restraint on a seat protected by an **ACTIVE AIRBAG** in front of it; **DEATH** or **SERIOUS INJURY** to the child can occur.

If the **PASSENGER AIR BAG OFF** indicator lamp stays off, do not install a rearward-facing child restraint system on the front-passenger seat. Further information can be found under "Problems with the automatic front-passenger front airbag deactivation system" (▷ page 52).

WARNING

If you secure a child in a forward-facing child restraint system on the front-passenger seat and you position the front-passenger seat too close to the dashboard, in the event of an accident, the child could:

- come into contact with the vehicle's interior if the PASSENGER AIR BAG OFF indicator lamp is lit, for example
- be struck by the airbag if the PASSENGER AIR BAG OFF indicator lamp is off

This poses an increased risk of injury or even fatal injury.

Always move the front-passenger seat as far back as possible and fully retract the seat cushion length. Always make sure that the shoulder belt strap is correctly routed from the vehicle belt sash guide to the shoulder belt guide on the child restraint system. The shoulder belt strap must be routed forwards and downwards from the vehicle belt sash guide. If necessary, adjust the vehicle belt sash guide and the front-passenger seat accordingly. Always observe the child restraint system manufacturer's installation instructions.

Always observe the vehicle-specific information for the correct positioning of the child restraint system (▷ page 59).

If the automatic front-passenger front airbag deactivation system detects that:

- the front-passenger seat is unoccupied, the PASSENGER AIR BAG OFF indicator lamp lights up after the system self-test and remains lit. This indicates that the front-passenger front airbag is disabled.
- the front-passenger seat is occupied by a child in a rearward-facing child restraint system, the PASSENGER AIR BAG OFF indicator lamp lights up after the system self-test and remains lit. This indicates that the front-passenger front airbag is disabled.

But in the case of a child in a rearward-facing child restraint system, the PASSENGER AIR BAG OFF indicator lamp can also go out after the system self-test. This indicates that the front-passenger front airbag is enabled. The result of the classification is dependent on,

among other factors, the child restraint system and the child's build. It is recommended that you fit the child restraint system to a suitable rear seat.

- the front-passenger seat is occupied by a child in a forward-facing child restraint system, either the PASSENGER AIR BAG OFF indicator lamp lights up and remains lit after the system self-test depending on the result of the classification, or it goes out. The result of the classification is dependent on, among other factors, the child restraint system and the child's build.

Move the front-passenger seat as far back as possible. Always observe the information in "Child restraint systems on the front-passenger seat" (▷ page 58) and in "Suitable positioning of the child restraint system" (▷ page 59). Alternatively, you can fit the child restraint system to a suitable rear seat.

- the front-passenger seat is occupied by a person with a smaller build (e.g. a teenager or small adult), the PASSENGER AIR BAG OFF indicator lamp lights up and remains lit after the system self-test depending on the result of the classification or, alternatively, goes out.
 - If the PASSENGER AIR BAG OFF indicator lamp is off, move the front-passenger seat as far back as possible. Alternatively, a person with a small build can sit on a rear seat.
 - If the PASSENGER AIR BAG OFF indicator lamp is lit, a person with a smaller build should not use the front-passenger seat.
- the front-passenger seat is occupied by an adult or a person with the build of an adult, the PASSENGER AIR BAG OFF indicator lamp goes out after the system self-test. This indicates that the front-passenger front airbag is enabled.

If children are travelling in the vehicle, be sure to observe the notes on "Children in the vehicle" (▷ page 55).

If the automatic front-passenger front airbag deactivation system is malfunctioning, the red  restraint system warning lamp on the instrument cluster and the PASSENGER AIR BAG OFF indicator lamp light up simultaneously. The front-passenger front airbag is disabled in this case and does not deploy during an accident. Have the automatic front-passenger front airbag deactivation system checked and repaired immediately at a qualified specialist workshop. Mercedes-Benz recommends that

you use a Mercedes-Benz Service Centre for this purpose.

If the front-passenger seat, the seat cover or the seat cushion are damaged, have the necessary repair work carried out at a qualified specialist workshop. Mercedes-Benz recommends that you use a Mercedes-Benz Service Centre for this purpose.

For safety reasons, Mercedes-Benz recommends that you use only a child restraint system that has been tested and approved by Mercedes-Benz in combination with the automatic front-passenger front airbag deactivation system.

System self-test

DANGER

If both the PASSENGER AIR BAG OFF and PASSENGER AIR BAG ON indicator lamps do not light up during the system self-test, the system is malfunctioning. The front-passenger front airbag might be triggered unintentionally or might not be triggered at all in the event of an accident with high deceleration. This poses an increased risk of injury or even fatal injury.

In this case the front-passenger seat may not be used. Do not install a child restraint system on the front-passenger seat. Have the automatic front-passenger front airbag deactivation system checked and repaired immediately at a qualified specialist workshop.

WARNING

If the PASSENGER AIRBAG OFF indicator lamp remains lit after the system self-test, the front-passenger front airbag is disabled. It will not be deployed in the event of an accident. In this case, the front-passenger front airbag cannot perform its intended protective function, e.g. when a person is seated in the front-passenger seat.

That person could, for example, come into contact with the vehicle's interior, especially if the person is sitting too close to the dashboard. This poses an increased risk of injury or even fatal injury.

When the front-passenger seat is occupied, always ensure that:

- the classification of the person in the front-passenger seat is correct and the front-passenger front airbag is enabled or disabled in accordance with the person in the front-passenger seat.
- the person is seated properly with a correctly fastened seat belt.
- the front-passenger seat has been moved as far back as possible.

If the PASSENGER AIR BAG OFF indicator lamp remains lit when it should not, the front-passenger seat may not be used. Do not install a child restraint system on the front-passenger seat. Have the automatic front-passenger front airbag deactivation system checked and repaired immediately at a qualified specialist workshop.

WARNING

Objects between the seat surface and the child restraint system could affect the function of the automatic front-passenger front airbag deactivation system. This could result in the front-passenger front airbag not functioning as intended during an accident. This poses an increased risk of injury or even fatal injury.

Do not place any objects between the seat surface and the child restraint system. The entire base of the child restraint system must always rest on the seat cushion of the front-passenger seat. The backrest of the forward-facing child restraint system must, as far as possible, be resting on the backrest of the rear reclining seat. Always comply with the child restraint system manufacturer's installation instructions.

After the system self-test, the PASSENGER AIR BAG OFF or PASSENGER AIR BAG ON indicator lamp displays the status of the front-passenger front airbag (▷ page 48). If the front-passenger front airbag is enabled, the PASSENGER AIR BAG ON indicator lamp lights up for 60 seconds and then goes out.

If the PASSENGER AIR BAG ON indicator lamp is off, only the PASSENGER AIR BAG OFF indicator lamp shows the status of the front-passenger front airbag. The PASSENGER AIR BAG OFF indicator lamp may be lit continuously or be off.

Further information can be found under "Problems with the automatic front-passenger front airbag deactivation system" (▷ page 52).

Problems with the automatic front-passenger front airbag deactivation system

Be sure to observe the notes on "System self-test" (▷ page 51).

Problem	Possible causes/consequences and ► Solutions
The PASSENGER AIR BAG OFF indicator lamp lights up and remains lit, even though the front-passenger seat is occupied by an adult or a person with a build corresponding to that of an adult.	<p>The classification of the person on the front-passenger seat is false.</p> <ul style="list-style-type: none"> ► Make sure the conditions for a correct classification of the person on the front-passenger seat are met (▷ page 48). ► If the PASSENGER AIR BAG OFF indicator lamp remains lit, the front-passenger seat may not be used. ► Have the automatic front-passenger front airbag deactivation system checked immediately at a qualified specialist workshop.
<p>The PASSENGER AIR BAG OFF indicator lamp does not light up and/or does not remain lit.</p> <p>The front-passenger seat is:</p> <ul style="list-style-type: none"> • empty • occupied by a rearward-facing child restraint system 	<p>The automatic front-passenger front airbag deactivation system is malfunctioning.</p> <ul style="list-style-type: none"> ► Make sure there is nothing between the seat and the child restraint system. ► Make sure that the entire base of the child restraint system rests on the seat cushion of the front-passenger seat. ► Make sure that the seat cushion length is fully retracted. ► When installing the child restraint system, make sure that the seat belt is tight. Do not pull the seat belt tight with the front-passenger seat adjustment. This could result in the seat belt and the child restraint system being pulled too tightly. ► Check that the child restraint system is installed correctly. ► Make sure that no objects are applying additional weight to the seat. ► If the PASSENGER AIR BAG OFF indicator lamp remains off and/or the PASSENGER AIR BAG ON indicator lamp lights up, do not install a rearward-facing child restraint system on the front-passenger seat. It is recommended that you fit the child restraint system to a suitable rear seat. ► Have the automatic front-passenger front airbag deactivation system checked immediately at a qualified specialist workshop.

Deployment of belt tensioners and airbags

Do not touch the airbag parts. Have a deployed airbag replaced at a qualified specialist workshop as soon as possible.

Important safety notes

WARNING

After the airbag deploys, the airbag parts are hot. There is a risk of injury.

WARNING

Pyrotechnical belt tensioners which have been triggered are no longer operational and

therefore cannot protect as intended. There is an increased risk of injury, possibly even fatal. Have pyrotechnic belt tensioners which have been triggered replaced at a qualified specialist workshop immediately.

Mercedes-Benz recommends that you have the vehicle towed to a qualified specialist workshop after an accident. Take this into account, particularly if a seat belt tensioner was triggered or an airbag was deployed.

An electric motor is used by PRE-SAFE® to trigger the tightening of the seat belt in hazardous situations. This procedure is reversible.

If the belt tensioners are triggered or an airbag is deployed, you will hear a bang, and a small amount of powder may also be released. The  restraint system warning lamp lights up.

Only in rare cases will the bang affect your hearing. In general, the powder released is not hazardous to health but may cause short-term breathing difficulties to persons suffering from asthma or other pulmonary conditions. Provided it is safe to do so, you should leave the vehicle immediately or open the window in order to prevent breathing difficulties.

Operation

During the first stage of a collision, the restraint system control unit evaluates important physical data relating to vehicle deceleration or acceleration, such as:

- duration
- direction
- intensity

Based on the evaluation of this data, the restraint system control unit triggers the seat belt tensioners in the event of a head-on or rear collision.

A seat belt tensioner can be triggered only if:

- the ignition is switched on
- the components of the restraint system are operational. You can find further information under: "Restraint system warning lamp" ([▷ page 41](#))
- the seat belt buckle tongue has engaged in the belt buckle of the respective front seat

The seat belt tensioners in the rear compartment are triggered independently of the lock status of the seat belts.

If the restraint system control unit detects a high-severity accident, in certain head-on collisions, additional components of the restraint system are deployed independently of each other:

- front airbags and driver's kneebag
- windowbag, if the system determines that deployment can offer additional protection to that provided by the seat belt

On vehicles with the automatic front-passenger front airbag deactivation system: depending on the person in the front-passenger seat, the front-passenger front airbag is either disabled or enabled. The front-passenger front airbag can be deployed in an accident only if the PASSENGER AIR BAG OFF indicator lamp is off. Observe the information on the PASSENGER AIR BAG indicator lamps ([▷ page 41](#)).

Your vehicle has two-stage front airbags. In the first deployment stage, the front airbag is filled with propellant gas. The front airbag is fully deployed if the second deployment stage is activated within a few milliseconds.

The activation threshold for the seat belt tensioners and airbags is determined based on the evaluation of the vehicle's rate of deceleration or acceleration at various points in the vehicle. This process is pre-emptive in nature. The triggering/deployment process should take place in good time at the start of the collision.

The rate of vehicle deceleration or acceleration and the direction of the force are essentially determined by:

- the distribution of forces during the collision
- the collision angle
- the deformation characteristics of the vehicle
- the characteristics of the object with which the vehicle has collided

Factors that can be seen and measured only after a collision has occurred do not play a decisive role in the deployment of an airbag. Nor do they provide an indication of airbag deployment.

The vehicle may be deformed significantly without an airbag being deployed. This is the case if only parts that are relatively easily deformed are affected and the rate of deceleration is not high. Conversely, an airbag may be deployed even though the vehicle suffers only minor deformation. This is the case if, for example, very rigid vehicle parts such as longitudinal body members are hit, and sufficient deceleration occurs as a result.

If the restraint system control unit detects a side impact, the applicable components of the restraint system are activated independently of each other.

Only for specific countries: a side impact or vehicle overturn can be detected. The applicable components of the restraint system are activated independently of each other depending on the apparent type of accident.

- Sidebags on the side on which an impact occurs, independently of the seat belt tensioner and seat belt usage
Vehicles with the automatic front-passenger front airbag deactivation system: the sidebag on the front-passenger side deploys under the following conditions:
 - an occupant is detected in the front-passenger seat or
 - the seat belt buckle tongue is engaged in the belt buckle of the front-passenger seat
- Windowbag on the side on which an impact occurs, independently of seat belt usage and regardless of whether the front-passenger seat is occupied
- Seat belt tensioners, if the system determines that deployment can offer additional protection for the vehicle occupants in this situation
- Only for specific countries: windowbags on the driver's and front-passenger side in certain situations if the vehicle overturns and if the system determines that deployment can offer additional protection to that provided by the seat belt

i Not all airbags are deployed in an accident. The different airbag systems work independently of each other.

How the airbag system works is determined by the severity of the accident detected, especially the vehicle deceleration or acceleration, and the apparent type of accident:

- frontal collision
- side impact
- Only for specific countries: overturn

PRE-SAFE® (anticipatory occupant protection)

Introduction

In certain hazardous situations, PRE-SAFE® takes pre-emptive measures to protect the vehicle occupants.

Important safety notes

! Make sure that there are no objects in the footwell or behind the seats. There is a risk that the seats and/or the objects could be damaged when PRE-SAFE® is activated.

Although your vehicle is equipped with PRE-SAFE®, the possibility of injury in the event of an accident cannot be ruled out. Always adapt your driving style to suit the prevailing road and weather conditions and maintain a safe distance from the vehicle in front. Drive carefully.

Function

PRE-SAFE® intervenes:

- in emergency braking situations, e.g. when BAS is activated
- in critical driving situations, e.g. when physical limits are exceeded and the vehicle understeers or oversteers severely
- when Active Brake Assist intervenes powerfully

PRE-SAFE® takes the following measures depending on the hazardous situation detected:

- the front seat belts are pre-tensioned
- if the vehicle skids, the side windows and the panorama sliding sunroof are closed
- vehicles with the memory function: the front-passenger seat is adjusted if it is in an unfavourable position

If the hazardous situation passes without resulting in an accident, PRE-SAFE® slackens the belt pre-tensioning. All settings made by PRE-SAFE® can then be reversed.

If the seat belt pre-tensioning is not reduced:

- ▶ Move the seat backrest or seat back slightly when the vehicle is stationary.
Seat belt pre-tensioning is reduced and the locking mechanism is released.

Seat-belt adjustment is an integral part of the PRE-SAFE® convenience function. Information

about the convenience function can be found under "Belt adjustment" (▷ page 44).

Automatic measures after an accident

Immediately after an accident, the following measures may be implemented, depending on the type and severity of the impact:

- the hazard warning lamps are activated
- the emergency lighting is activated
- the vehicle doors are unlocked
- the front side windows are lowered
- the engine is switched off and the fuel supply is cut off
- vehicles with the Mercedes-Benz emergency call system: automatic emergency call

Children in the vehicle

Important safety notes

Accident statistics show that children secured on the rear seats are safer than children secured on the front seats. For this reason, Mercedes-Benz strongly advises that you install the child restraint system on a rear seat. Children are generally better protected there.

If a child younger than twelve years old and under 1.50 m in height is travelling in the vehicle:

- always secure the child in a child restraint system suitable for Mercedes-Benz vehicles. The child restraint system must be appropriate to the age, weight and size of the child
- be sure to observe the instructions and safety notes in this section in addition to the child restraint system manufacturer's installation instructions.
- always observe the instructions and safety notes on the automatic front-passenger front airbag deactivation system(▷ page 48)

WARNING

If you leave children unattended in the vehicle, they may be able to set the vehicle in motion if, for example, they:

- release the parking brake
- shift the automatic transmission out of park position **P** or shift manual transmission into neutral
- start the engine

In addition, they may operate vehicle equipment and become trapped. There is a risk of an accident and injury.

When leaving the vehicle, always take the key with you and lock the vehicle. Never leave children unattended in the vehicle.

WARNING

If persons (particularly children) are exposed to heat or cold for a prolonged period, there is a risk of serious or even fatal injuries. Never leave persons (particularly children) unattended in the vehicle.

WARNING

If the child restraint system is placed in direct sunlight, the parts could become very hot. Children could be suffer burns by touching these parts, in particular on the metallic parts of the child restraint system. There is a risk of injury.

If you and your child leave the vehicle, always make sure that the child restraint system is not in direct sunlight. Cover it with a blanket, for example. If the child restraint system has been exposed to direct sunlight, leave it to cool down before securing the child in it. Never leave children unattended in the vehicle.

Always ensure that all vehicle occupants have their seat belts fastened correctly and are sitting properly. Particular attention must be paid to children.

Observe the safety notes on the seat belt (▷ page 42) and the information on the correct use of the seat belt (▷ page 43).

Child restraint system

If you fit a rearward-facing child restraint system to the centre rear seat, the rear armrest must be folded back as far as possible.

Observe the instructions for correct use of the child restraint system (▷ page 59).

For safety reasons, Mercedes-Benz recommends that you use only a child restraint system recommended by Mercedes-Benz (▷ page 62).

WARNING

If the child restraint system is incorrectly fitted on the seat position suitable for this purpose, it cannot perform its intended protective function. In the event of an accident, sharp braking or a sudden change in direction, the child may not be held securely. There is an increased risk of serious or even fatal injuries.

Observe the manufacturer's installation instructions and the correct use for the child restraint system. Make sure that the entire surface of the child restraint system is resting on the seat surface. Never place objects under or behind the child restraint system, e.g. cushions. Only use child restraint systems with the original cover designed for them. Only replace damaged covers with genuine covers.

WARNING

If the child restraint system is fitted incorrectly or is not secured, it can come loose in the event of an accident, heavy braking or a sudden change in direction. The child restraint system could be thrown about, striking vehicle occupants. There is an increased risk of injury, possibly even fatal.

Always fit child restraint systems properly, even if they are not being used. Make sure that you observe the child restraint system manufacturer's installation instructions.

You will find further information on stowing objects, luggage and loads securely under "Loading guidelines" (▷ page 271).

WARNING

Child restraint systems or their securing systems that have been damaged or subjected to a load in an accident cannot perform their intended protective function. In the event of an accident, sharp braking or a sudden change in direction, the child may not be held securely. There is an increased risk of serious or even fatal injuries.

Immediately replace child restraint systems that have been damaged or subjected to a load in an accident. Have the child restraint securing systems checked in a qualified specialist workshop before fitting a child restraint system again.

The securing systems of child restraint systems are:

- the seat belt system
- the ISOFIX securing rings
- the Top Tether anchorages

If circumstances require you to fit a child restraint system to the front-passenger seat, be sure to observe the information on "Child restraint systems on the front-passenger seat" (▷ page 58).

Observe the warning labels in the vehicle interior and on the child restraint system.

 It is advisable to use Mercedes-Benz care products to clean child restraint systems recommended by Mercedes-Benz. Information can be obtained at a qualified specialist workshop.

ISOFIX child seat securing system

WARNING

For ISOFIX child restraint systems in which the child is secured using the safety belt integrated in the child restraint system, the maximum permissible weight of the child and child restraint system together is 33 kg.

If the child and the child restraint system together weigh more than 33 kg, the ISOFIX child restraint system with integrated safety belt no longer offers sufficient protection. The ISOFIX child seat securing system may be

overloaded, and the child may not be restrained in an accident, for example. This poses an increased risk of injury or even fatal injury.

If the child and the child restraint system together weigh more than 33 kg, use only an ISOFIX child restraint system in which the child is also secured with the vehicle seat belt. Also secure the child restraint system with the top tether belt, if available.

Regularly check that the maximum permissible weight of the child and child restraint system together is still complied with.

When fitting a child restraint system, be sure to observe the manufacturer's installation and operating instructions and the instructions for correct use of the child restraint system (▷ page 59).

Before every trip, make sure that the ISOFIX child restraint system is engaged correctly in both ISOFIX securing rings.

- ❗ When fitting the child restraint system, make sure that the seat belt for the centre seat does not get trapped. Otherwise, the seat belt could be damaged.

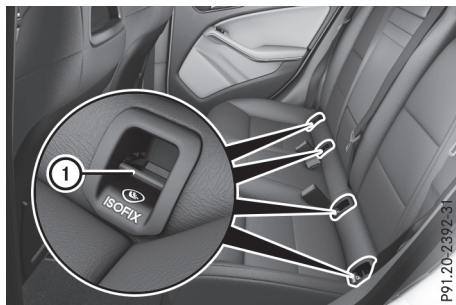

- Install the ISOFIX child restraint system on both ISOFIX securing rings ①.

ISOFIX is a standardised securing system for specially designed child restraint systems on the rear seats. The ISOFIX securing rings for two ISOFIX child restraint systems are fitted on the left and right of the rear seats.

Child restraint systems without an ISOFIX child seat securing system should be fitted using the seat belts in the vehicle. When fitting a child restraint system, be sure to observe the manufacturer's installation and operating instruc-

tions and the instructions for correct use of the child restraint system (▷ page 59).

Top tether

Introduction

Top Tether provides an additional connection between the child restraint system secured with ISOFIX and the vehicle. It helps reduce the risk of injury even further. If the child restraint system is fitted with a Top Tether belt, this should always be used.

Important safety notes

⚠ WARNING

If the rear seat backrests are not locked, they could fold forwards in the event of an accident, heavy braking or sudden changes of direction. As a result, child restraint systems cannot perform their intended protective function. Rear seat backrests that are not locked can also cause additional injuries, e.g. in the event of an accident. This poses an increased risk of injury or even fatal injury.

Always lock rear seat backrests after fitting a Top Tether belt. Observe the lock verification indicator. Adjust the rear seat backrests so that they are in an upright position.

If the rear seat backrest is not engaged and locked, the red lock indicator is visible (▷ page 274).

Top Tether anchorage points

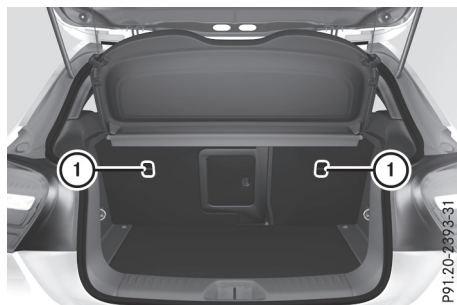

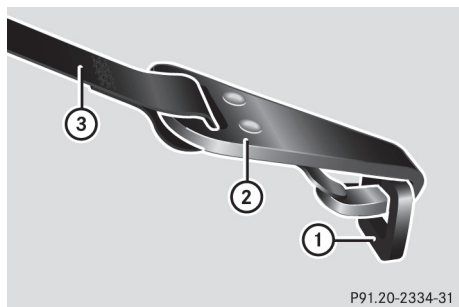

P91.20-2334-31

Top Tether anchorage points are located on the rear side of both outer rear seat backrests.

Vehicles with adjustable head restraints

- ▶ Move the head restraint upwards.
- ▶ Route Top Tether belt ③ under the head restraint between the two head restraint bars.

Vehicles without adjustable head restraints

- ▶ **Top Tether belt with one belt strap:** route Top Tether belt ③ centrally over the head restraint.

or

- ▶ **Top Tether belt with two belt straps:** route one Top Tether belt ③ to the left and one to the right past the side of the head restraint.

All vehicles

- ▶ Fit the ISOFIX child restraint system with Top Tether. Always comply with the child restraint system manufacturer's installation instructions when doing so.
 - ▶ Hook Top Tether hook ② of Top Tether belt ③ into Top Tether anchorage ①.
- Make sure that:
- Top Tether hook ② is hooked into Top Tether anchorage ①, as shown
 - Top Tether belt ③ is not twisted
 - Top Tether belt ③ is routed between the seat backrest and the load compartment cover if the load compartment cover is fitted
- ▶ Tension Top Tether belt ③. Always comply with the child restraint system manufacturer's installation instructions when doing so.

Vehicles with adjustable head restraints

- ▶ If necessary, move head restraint back down again slightly (▷ page 100). Make sure that you do not interfere with the correct routing of Top Tether belt ③.

Child restraint system on the front-passenger seat

General notes

Accident statistics show that children secured on the rear seats are safer than children secured on the front seats. For this reason, Mercedes-Benz strongly advises that you install a child restraint system on a rear seat.

Vehicles with the automatic front-passenger front airbag deactivation system:

if circumstances require you to fit a child restraint system to the front-passenger seat, be sure to observe the information on the "Automatic front-passenger front airbag deactivation system" (▷ page 48).

You can thus avoid the risks that could arise as a result of:

- a child restraint system that is not detected by the automatic front-passenger front airbag deactivation system
- unintentional disabling of the front-passenger front airbag
- unsuitable positioning of the child restraint system, e.g. too close to the dashboard



P68.60-2431-31

Please observe the warning notice on the front-passenger sun visor; see illustration.

⚠ WARNING

If you secure a child in a rearward-facing child restraint system on the front-passenger seat and the PASSENGER AIR BAG OFF indicator lamp is off, the front-passenger front airbag can deploy in the event of an accident. The child could be struck by the airbag. This poses an increased risk of injury or even fatal injury.

Make sure that the front-passenger front airbag has been disabled. The PASSENGER AIR BAG OFF indicator lamp must be lit.

NEVER use a rearward-facing child restraint on a seat protected by an ACTIVE AIRBAG in front of it; DEATH or SERIOUS INJURY to the child can occur.

If the PASSENGER AIR BAG OFF indicator lamp goes out, the front-passenger front airbag is enabled (▷ page 41).

Vehicles without the automatic front-passenger front airbag deactivation system



If the front-passenger seat of your vehicle is not equipped with the automatic front-passenger front airbag deactivation system, this is indicated by a special sticker. The sticker is affixed to the side of the dashboard on the front-passenger side. The sticker is visible when you open the front-passenger door.

If you turn the key to position **2** in the ignition lock, the PASSENGER AIR BAG OFF and PASSENGER AIR BAG ON indicator lamps light up briefly. However, they have no function and do not indicate that there is an automatic front-passenger front airbag deactivation system.

In this case, never fit a rearward-facing child restraint system on the front passenger seat (▷ page 59).

Observe the following information under "Rearward-facing child restraint system" (▷ page 59) and "Forward-facing child restraint system" (▷ page 59) as well as information on the suitable positioning of the child restraint system (▷ page 59).

Rearward-facing child restraint system

If circumstances require you to fit a rearward-facing child restraint system on the front-passenger seat, always make sure that the front-passenger front airbag is disabled. Only if the PASSENGER AIR BAG OFF indicator lamp is lit continuously (▷ page 41) is the front-passenger front airbag disabled.

Always observe the information on suitable positioning of the child restraint system (▷ page 59) in addition to the child restraint system manufacturer's installation and operating instructions.

Forward-facing child restraint system

If circumstances require you to fit a forward-facing child restraint system on the front-passenger seat, always move the front-passenger seat as far back as possible. Fully retract the seat cushion. The entire base of the child restraint system must always rest on the seat cushion of the front-passenger seat. The backrest of the child restraint system must sit as flat as possible against the backrest of the front-passenger seat. The child restraint system must not touch the roof or be put under strain by the head restraint. Adjust the angle of the seat backrest and the head restraint position accordingly. Always make sure that the shoulder belt strap is correctly routed from the vehicle belt outlet to the shoulder belt guide on the child restraint system. The shoulder belt strap must be routed forwards and downwards from the vehicle belt outlet. If necessary, adjust the vehicle belt outlet and the front-passenger seat accordingly.

Always observe the information on suitable positioning of the child restraint system (▷ page 59) in addition to the child restraint system manufacturer's installation and operating instructions.

Suitable positioning of the child restraint system

Introduction

Only child restraint systems that are approved in accordance with ECE standard ECE R44 are permitted for use in the vehicle.

For certain child restraint systems in weight group 3, this can mean that the area of use is

restricted. The maximum size setting of the child restraint system may not be possible due to the risk of contact with the roof.

"Universal"-category child restraint systems can be recognised by their orange approval label and the text "Universal".

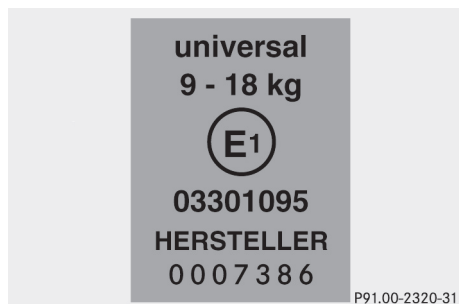

Example: approval label on the child restraint system

ISOFIX child restraint systems in the "Universal" category can be used on seats labelled U, UF or IUF in accordance with the following tables:

- suitability of the seats for attaching a belt-secured child restraint system
- suitability of the seats for attaching an ISOFIX child restraint system

Semi-universal child restraint systems are indicated by the text "semi-universal" on the approval label. These can be used if the vehicle and the seat are listed on the child restraint system manufacturer's vehicle model list. For more information, contact the child restraint system manufacturer or visit the manufacturer's website.

Child restraint system on the front-passenger seat – if it is absolutely necessary to secure a child in a child restraint system on the front-passenger seat:

- ▶ Always pay attention to the instructions under "Child restraint system on the front-passenger seat" (▷ page 58).

There, you will find instructions on how to route the shoulder belt strap correctly from the vehicle belt outlet to the shoulder belt guide on the child restraint system (▷ page 59).

- ▶ Move the front-passenger seat as far back as possible and fully retract the seat cushion.

If you secure a child in a forward-facing child restraint system on the front-passenger seat, you must also move the front-passenger seat to the highest position.

- ▶ Move the backrest to an almost vertical position.

The entire base of the child restraint system must always rest on the seat cushion of the front-passenger seat. The backrest of a forward-facing child restraint system must, as far as possible, rest flat against the backrest of the front-passenger seat. The child restraint system must not touch the roof or be put under strain by the head restraint. Adjust the angle of the seat backrest and the head restraint position accordingly. Also observe the child restraint system manufacturer's installation instructions.

- ▶ Set the seat cushion angle in such a way that the front of the seat cushion is in the topmost position and the rear of the seat cushion in the lowest position (▷ page 98).

Suitability of the seats for attaching a belt-secured child restraint system

If you use a baby car seat in Group 0 or 0+ or a rearward-facing child restraint system in Group 1 on a rear seat, you must adjust the driver's or front-passenger seat so that the seat does not touch the child restraint system.

If you use a Group 1, forward-facing child restraint system, you should remove the head restraint from the respective seat, if possible (▷ page 101). The backrest of the child restraint system must, as far as possible, lie flat against the backrest of the seat.

Make sure that the child's feet do not touch the front seat. If necessary, move the front seat forwards slightly.

For certain child restraint systems in weight groups 2 or 3, this can mean that the area of use is restricted. The maximum size setting of the child restraint system may not be possible due to the risk of contact with the roof.

Always observe the notes in the "Child restraint system" section (▷ page 56) and the child restraint system manufacturer's installation instructions.

When you remove the child restraint system, you must replace the head restraints again immediately (▷ page 99). All vehicle occupants must adjust their head restraints correctly before beginning a journey.

Legend for the table:

- X Seat that is unsuitable for children in this weight group.
- U Suitable for child restraint systems in the "Universal" category that are approved for use in this weight group.
- UF Suitable for forward-facing child restraint systems that belong to the "Universal" category and are approved for use in this weight group.
- L Suitable for child restraint systems as recommended; see the "Recommended child restraint systems" table (▷ page 62). Suitable for semi-universal child restraint systems if the vehicle and the seat are listed on the child restraint system manufacturer's vehicle model list.

Weight group		Front-passenger seat		Rear seat	
		Front-passenger front airbag enabled	Front-passenger front airbag disabled ¹	Left, right	Centre ²
0	up to 10 kg	X	U, L	U, L	U, L
0+	up to 13 kg	X	U, L	U, L	U, L
I	9 kg to 18 kg	UF, L	U, L	U, L	U, L
II	15 kg to 25 kg	UF, L	U, L	U, L	X
III	22 kg to 36 kg	UF, L	U, L	U, L	X

Suitability of the seats for attaching an ISOFIX child restraint system

If you use a baby car seat in Group 0 or 0+ or a rearward-facing child restraint system in Group 1 on a rear seat, you must adjust the driver's or front-passenger seat so that the seat does not touch the child restraint system.

If you use a Group 1, forward-facing child restraint system, you should remove the head restraint from the respective seat, if possible (▷ page 101). The backrest of the child restraint system must, as far as possible, lie flat against the backrest of the seat.

Make sure that the child's feet do not touch the front seat. If necessary, move the front seat forwards slightly.

For certain child restraint systems in weight groups 2 or 3, this can mean that the area of use is restricted. The maximum size setting of the child restraint system may not be possible due to the risk of contact with the roof.

Always observe the notes in the "Child restraint system" section (▷ page 56) and the child restraint system manufacturer's installation instructions.

When you remove the child restraint system, you must replace the head restraints again immediately (▷ page 99). All vehicle occupants must adjust their head restraints correctly before beginning a journey.

¹ The vehicle is equipped with an automatic front-passenger front airbag deactivation system. The PASSENGER AIR BAG OFF indicator lamp must be lit.

² Child restraint systems with a supporting bracket are not suitable for this seat.

Legend for the table:

- X ISOFIX position that is not suitable for ISOFIX child restraint systems in this weight group and/or size class.
- IUF Suitable for forward-facing ISOFIX child restraint systems that belong to the "Universal" category and are approved for use in this weight group.
- IL Suitable for ISOFIX child restraint systems as recommended; see the "Recommended child restraint systems" table (▷ page 62).

The manufacturer will also recommend a suitable ISOFIX child restraint system. For this, your vehicle and the seat must be listed on the child restraint system manufacturer's model list. For more information, contact the child restraint system manufacturer or visit the manufacturer's website.

Weight group		Size class	Equipment	Rear seat left, right
Carry cot		F	ISO/L1	X
		G	ISO/L2	X
0	up to 10 kg up to approximately 6 months	E	ISO/R1	IL
0+	up to 13 kg up to approximately 15 months	E	ISO/R1	IL
		D	ISO/R2	IL
		C	ISO/R3	IL ³
I	9 kg to 18 kg between approximately 9 months and 4 years	D	ISO/R2	IL
		C	ISO/R3	IL ³
		B	ISO/F2	IUF
		B1	ISO/F2X	IUF
		A	ISO/F3	IUF

The child restraint system must not touch the roof or be put under strain by the head restraints. Adjust the head restraint position accordingly. Also observe the child restraint system manufacturer's installation instructions.

Vehicles with the Style or Urban package or 4-way or 6-way front seats: set the front seat to the highest position.

Vehicles with 2-way front seats: set the front seat to the foremost position.

Recommended child restraint systems

General notes

Always observe the information in "Child restraint systems on the front-passenger seat" (▷ page 58) and in "Suitable positioning of the child restraint system" (▷ page 59).

You can obtain further information about the correct child restraint system from any Mercedes-Benz Service Centre.

³ If you are using a child restraint system in size class C (ISO/R3), make sure that the front seat backrest does not rest against the child restraint system.

Recommended child restraint systems for attaching with the vehicle seat belt

Weight categories	Manufacturer	Type	Approval number (E1 ...)	Order number (A 000 ...) ⁴
Category 0: up to 10 kg up to approximately 6 months	Britax Römer	BABY SAFE plus II	04 301146	970 36 00 970 57 00
Category 0+: up to 13 kg up to approximately 15 months	Britax Römer	BABY SAFE plus II	04 301146	970 36 00 970 57 00
Category I: 9 kg to 18 kg between approximately 9 months and 4 years	Britax Römer	DUO plus	04 301133	970 37 00 970 58 00
Category II/III: 15 kg to 36 kg between approximately 4 years and 12 years	Britax Römer	KIDFIX	04 301198	970 38 00 970 59 00
	Britax Römer	KIDFIX XP	04 301304	970 61 00

Recommended "Universal" / "Semi-Universal" category ISOFIX child restraint systems

Weight categories	Size category	Manufacturer	Type	Approval number (E1 ...)	Order number ⁴
Category 0+: up to 13 kg	E	Britax Römer	BABY SAFE plus	04 301146	B6 6 86 8224
Category I: 9 kg to 18 kg	B1	Britax Römer	DUO plus	04 301133	A 000 970 37 00 A 000 970 58 00

⁴ Colour code 9H95.

Child-proof locks

Important safety notes

WARNING

If children are travelling in the vehicle, they could:

- open doors, thus endangering other people or road users
- exit the vehicle and be caught by oncoming traffic
- operate vehicle equipment and become trapped, for example

There is a risk of an accident and injury.

Always activate the child-proof locks and override feature if children are travelling in the vehicle. When leaving the vehicle, always take the key with you and lock the vehicle. Never leave children unattended in the vehicle.

Override feature for:

- the rear doors (> page 64)
- the rear side windows (> page 65)

WARNING

If you leave children unattended in the vehicle, they may be able to set the vehicle in motion if, for example, they:

- release the parking brake
- shift the automatic transmission out of park position **P** or shift manual transmission into neutral
- start the engine

In addition, they may operate vehicle equipment and become trapped. There is a risk of an accident and injury.

When leaving the vehicle, always take the key with you and lock the vehicle. Never leave children unattended in the vehicle.

WARNING

If persons (particularly children) are exposed to heat or cold for a prolonged period, there is a risk of serious or even fatal injuries. Never leave persons (particularly children) unattended in the vehicle.

WARNING

If the child restraint system is placed in direct sunlight, the parts could become very hot. Children could suffer burns by touching these parts, in particular on the metallic parts of the child restraint system. There is a risk of injury.

If you and your child leave the vehicle, always make sure that the child restraint system is not in direct sunlight. Cover it with a blanket, for example. If the child restraint system has been exposed to direct sunlight, leave it to cool down before securing the child in it. Never leave children unattended in the vehicle.

Child-proof locks for the rear doors

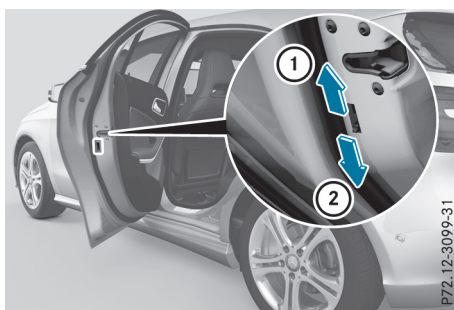

You can secure each door individually with the child-proof locks on the rear doors. A door secured with a child-proof lock cannot be opened from inside the vehicle. When the vehicle is unlocked, the door can be opened from the outside.

- ▶ **To activate:** press the child-proof lock lever up in the direction of arrow ①.
- ▶ Make sure that the child-proof lock is working properly.
- ▶ **To deactivate:** press the child-proof lock lever down in the direction of arrow ②.

Child-proof locks for the rear side windows

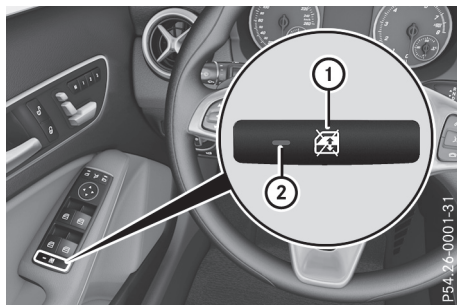

- **To enable/disable:** press button ①.
If indicator lamp ② is lit, operation of the rear side windows is disabled. Operation is only possible using the switches in the driver's door. If indicator lamp ② is off, operation is possible using the switches in the rear compartment.

Pets in the vehicle

⚠ WARNING

If you leave animals unsupervised or unsecured in the vehicle, they may push a button or a switch, for example.

They could:

- activate vehicle equipment and become trapped, for example
- switch vehicle systems on or off, thus endangering other road users

In the event of an accident, sudden braking or abrupt changes of direction, unsecured animals could be flung around the vehicle, injuring the vehicle occupants. There is a risk of an accident and injury.

Never leave animals unattended in the vehicle. Always secure animals correctly during a journey, e.g. in an animal transport box.

Driving safety systems

Driving safety systems overview

In this section, you will find information about the following driving safety systems:

- **ABS (Anti-lock Braking System)** (▷ page 65)
- **BAS (Brake Assist System)** (▷ page 66)
- **Active Brake Assist** (▷ page 66)
- **Adaptive brake lights** (▷ page 69)
- **ESP® (Electronic Stability Program)** (▷ page 69)
- **EBD (electronic brake force distribution)** (▷ page 72)
- **ADAPTIVE BRAKE** (▷ page 73)
- **STEER CONTROL** (▷ page 73)

Important safety notes

If you fail to adapt your driving style or if you are inattentive, the driving safety systems can neither reduce the risk of an accident nor override the laws of physics. Driving safety systems are merely aids designed to assist driving.

You are responsible for maintaining the distance to the vehicle in front, for vehicle speed, for braking in good time, and for staying in lane. Always adapt your driving style to suit the prevailing road and weather conditions and maintain a safe distance from the vehicle in front. Drive carefully.

The driving safety systems described work as effectively as possible only when there is adequate contact between the tyres and the road surface. Please pay special attention to the notes on tyres, recommended minimum tyre tread depths etc. (▷ page 317).

In wintry driving conditions, always use winter tyres (M+S tyres) and, if necessary, snow chains. Only in this way will the driving safety systems described in this section work as effectively as possible.

ABS (Anti-lock Braking System)

General information

ABS regulates brake pressure in such a way that the wheels do not lock when you brake. This

allows you to continue steering the vehicle when braking.

The  ABS warning lamp on the instrument cluster lights up when the ignition is switched on. It goes out when the engine is running.

ABS works from a speed of about 8 km/h, regardless of road-surface conditions. ABS works on slippery surfaces, even when you brake only gently.

Important safety notes

 Observe the "Important safety notes" section (▷ page 65).

WARNING

If ABS is malfunctioning, the wheels could lock when braking. The steerability and braking characteristics are thus severely impaired. There is an increased risk of skidding and an accident.

Drive on carefully. Have the ABS checked at a qualified specialist workshop as soon as possible.

If ABS is malfunctioning, other systems, including driving safety systems, will also become inoperative. Observe the information on the ABS warning lamp (▷ page 251) and display messages that may be shown on the instrument cluster (▷ page 219).

Brakes

- ▶ **If ABS intervenes:** continue to depress the brake pedal with force until the braking situation is over.
- ▶ **To make a full brake application:** depress the brake pedal with full force.

If ABS intervenes when braking, you will feel a pulsing in the brake pedal.

The pulsating brake pedal can be an indication of hazardous road conditions; this serves as a reminder to take extra care while driving.

BAS (Brake Assist System)

General notes

BAS operates in emergency braking situations. If you depress the brake pedal quickly, BAS automatically boosts the braking force, thus shortening the stopping distance.

Important safety notes

 Read the "Important safety notes" section (▷ page 65).

WARNING

If BAS is malfunctioning, the braking distance in an emergency braking situation is increased. There is a risk of accident.

In an emergency braking situation, depress the brake pedal with full force. ABS prevents the wheels from locking.

Braking

- ▶ Keep the brake pedal depressed firmly until the emergency braking situation is over. ABS prevents the wheels from locking.

The brakes will function as usual once you release the brake pedal. BAS is deactivated.

Active Brake Assist

General information

 Observe the "Important safety notes" section (▷ page 65).

Active Brake Assist consists of a distance warning function with an autonomous braking function and situation-dependent braking assistance.

Active Brake Assist can help you to minimise the danger of collision with the vehicle in front or reduce the effects of such a collision.

If Active Brake Assist detects that there is a risk of collision, you will be warned visually and audibly. If you do not react to the visual and audible collision warning, autonomous braking can be initiated in critical situations. If you apply the brake yourself in a critical situation, Adaptive Brake Assist supports you with situation-dependent braking assistance.

Important safety notes

Detection of hazardous situations can be particularly impaired by:

- dirt on the sensors or obscured sensors
- snow or heavy rain
- interference by other radar sources
- strong radar reflections for example, in multi-storey car parks
- a narrow vehicle travelling in front, e.g. a motorcycle
- a vehicle travelling in front on a different line
- new vehicles or after servicing is carried out on the Active Brake Assist system

Observe the important safety notes in the "Running-in notes" section (▷ page 134).

Following damage to the front end of the vehicle, have the configuration and operation of the radar sensor checked at a qualified specialist workshop. This also applies to collisions at low speeds where no visible damage to the front of the vehicle is apparent.

Activating/deactivating

Active Brake Assist is active after every ignition cycle.

You can activate or deactivate Active Brake Assist (▷ page 211) by using the on-board computer. When the system is deactivated, the distance warning function and the autonomous braking function are also deactivated.

Vehicles with a black and white multifunction display: when Active Brake Assist is activated, the  symbol appears in the status overview of the multifunction display.

Vehicles with a colour multifunction display: when Active Brake Assist is deactivated, the  symbol appears in the assistance graphic display of the multifunction display.

Distance warning function

General information

The distance warning function can help you to minimise the danger of collision with the vehicle in front or reduce the effects of such a collision. If the distance warning function detects a risk of collision with the vehicle in front, you will be warned visually and audibly.

Important safety notes

i Observe the "Important safety notes" section for driving safety systems (▷ page 65).

WARNING

The distance warning function does not react:

- to people or animals
- to oncoming vehicles
- to crossing traffic
- when cornering

The distance warning function may not give warnings in all critical situations. There is a risk of an accident.

Always pay careful attention to the traffic situation and be ready to brake.

Always adapt your speed to suit the prevailing road and traffic conditions.

WARNING

The distance warning function cannot always clearly identify objects and complex traffic situations.

In such cases, the distance warning function may:



- give an unnecessary warning
- not give a warning

There is a risk of an accident.

Always pay careful attention to the traffic situation; do not rely on the distance warning function alone.

Function

The distance warning function issues a warning at speeds:

- of approximately 30 km/h or more if, over several seconds, the distance to the vehicle travelling in front is insufficient for the driving speed. The  distance warning lamp will then light up on the instrument cluster.
- of approximately 7 km/h or more if you rapidly approach a vehicle in front. An intermittent warning tone will then sound and the  distance warning lamp will light up on the instrument cluster.

- ▶ Brake immediately to increase the distance from the vehicle in front.

or

- ▶ Take evasive action provided it is safe to do so.

Due to the nature of the system, certain complex but non-critical driving conditions may also cause the system to display a warning.

With the help of the radar sensor system, the distance warning function can detect obstacles that are in the path of your vehicle for an extended period of time.

Up to a speed of approximately 70 km/h, the distance warning function can also react to stationary obstacles, such as stopped or parked vehicles.

Autonomous braking function

If the driver does not react to the distance warning signal in a critical situation, Active Brake Assist can assist the driver with the autonomous braking function.

The autonomous braking function:

- gives the driver more time to react to critical driving situations
- can help the driver to avoid an accident or
- reduces the effects of an accident

Vehicles without Distance Pilot DISTRONIC: the autonomous braking function is available in the following speed ranges:

- 7 - 105 km/h for moving objects
- 7 - 50 km/h for stationary objects

Vehicles with Distance Pilot DISTRONIC: the autonomous braking function is available in the following speed ranges:

- 7 - 200 km/h for moving objects
- 7 - 50 km/h for stationary objects

Due to the nature of the system, complex but non-critical driving conditions may also cause the autonomous braking function to engage.

If the autonomous braking function demands particularly high braking force, preventative passenger protection measures (PRE-SAFE®) are activated simultaneously (▷ page 54).

Situation-dependent braking assistance

General information

- i** Observe the "Important safety notes" section (▷ page 65).

With the help of the radar sensor system, Adaptive Brake Assist can detect obstacles that are in the path of your vehicle for an extended period of time.

If Adaptive Brake Assist detects a risk of collision with the vehicle in front, it calculates the brake pressure necessary to avoid a collision. If you apply the brakes forcefully, the situation-dependent braking assistance automatically increases the brake pressure to a degree appropriate to the traffic situation.

Situation-dependent braking assistance provides braking assistance in hazardous situations at speeds above 7 km/h. It uses the radar sensor system to assess the traffic situation.

Situation-dependent braking assistance is capable of reacting to moving objects which have already been recognised as such at least once over the period of observation, up to a speed of around 250 km/h.

Situation-dependent braking assistance can also detect stationary objects, up to a speed of around 70 km/h.

If situation-dependent braking assistance demands particularly high brake pressure, preventative passenger protection measures (PRE-SAFE®) are triggered simultaneously (▷ page 54).

- ▶ Keep the brake pedal depressed until the emergency braking situation is over. ABS prevents the wheels from locking.

The brakes will work normally again if:

- you release the brake pedal
- a danger of collision with the vehicle in front no longer exists
- no obstacle is detected in front of your vehicle

Situation-dependent braking assistance is then deactivated.

Important safety notes

- i** Observe the "Important safety notes" section for driving safety systems (▷ page 65).

⚠ WARNING

Active Brake Assist does not react:

- to persons, bicycles, motorcycles or animals
- to approaching vehicles
- to cross traffic
- on bends

As a result, Active Brake Assist cannot intervene in all critical situations. There is a risk of an accident.

Always pay careful attention to the traffic situation and be prepared to brake.

⚠ WARNING

Adaptive Brake Assist cannot always clearly identify objects and complex traffic situations.

In such cases, Adaptive Brake Assist might:

- intervene unnecessarily
- not intervene

The risk of an accident remains.

Always pay careful attention to the traffic situation and be ready to brake. Terminate the intervention in a non-critical driving situation.

Due to the nature of the system, complex but non-critical driving conditions may also cause Active Brake Assist to intervene.

Even if Active Brake Assist is not available due to a malfunction in the radar sensor system, the brake system is still available with full brake boosting effect and BAS.

Adaptive brake lights

The adaptive brake lights warn following traffic in an emergency braking situation by:

- flashing brake lamps
- the hazard warning lamps are activated

If you brake sharply from a speed of more than 50 km/h or if braking is assisted by BAS or BAS PLUS, the brake lamps flash rapidly. In this way, traffic travelling behind you is warned in an even more noticeable manner.

If you brake sharply from a speed of more than 70 km/h to a standstill, the hazard warning

lamps are switched on automatically. If the brakes are applied again, the brake lamps light up continuously. The hazard warning lamps switch off automatically if you travel faster than 10 km/h. You can also switch off the hazard warning lamps using the hazard warning button (▷ page 109).

ESP® (Electronic Stability Program)**General notes**

- i** Observe the "Important safety notes" section (▷ page 65).

ESP® monitors driving stability and traction, i.e. power transmission between the tyres and the road surface.

If ESP® detects that the vehicle is deviating from the direction desired by the driver, one or more wheels are braked to stabilise the vehicle. The engine output is also modified to keep the vehicle on the desired course within physical limits. ESP® assists the driver when pulling away on wet or slippery roads. ESP® can also stabilise the vehicle during braking.

ETS/4ETS (Electronic Traction System)

- i** Observe the "Important safety notes" section (▷ page 65).

ETS traction control is part of ESP®. On vehicles with 4MATIC, 4ETS is part of ESP®.

Traction control brakes the drive wheels individually if they spin. This enables you to pull away and accelerate on slippery surfaces, e.g. if the road surface is slippery on one side. In addition, more drive torque is transferred to the wheel or wheels with traction.

Traction control remains active if you deactivate ESP®.

Important safety notes

- i** Observe the "Important safety notes" section (▷ page 65).



⚠ WARNING

If ESP® is malfunctioning, ESP® is unable to stabilise the vehicle. In addition, other driving safety systems are switched off. This increases the risk of skidding and an accident.

Drive on carefully. Have ESP® checked at a qualified specialist workshop.

Vehicles without 4MATIC: when towing your vehicle with the front axle raised, it is important that you observe the notes on ESP® (▷ page 311).

If the  ESP® OFF warning lamp lights up continuously, ESP® is deactivated.

If the  ESP® warning lamp and the  warning lamp are lit continuously, ESP® is not available due to a malfunction.

Read the information on warning lamps (▷ page 253) and display messages that may be shown in the instrument cluster (▷ page 219).

Use only wheels with the recommended tyre sizes. Only then will ESP® function properly.

Characteristics of ESP®

General information

If the  ESP warning lamp goes out before you begin the journey, ESP® is automatically active.

If ESP® intervenes, the  ESP® warning lamp flashes on the instrument cluster.

If ESP® intervenes:

- ▶ Do not deactivate ESP® under any circumstances.
- ▶ When pulling away, depress the accelerator pedal only as far as is necessary.
- ▶ Adapt your driving style to suit the prevailing road and weather conditions.

ECO start/stop function

The ECO start/stop function switches the engine off automatically if the vehicle stops moving. When pulling away again, the engine starts automatically. ESP® remains in its previously selected status. **Example:** if ESP® was deactivated before the engine was switched off, ESP® remains deactivated when the engine is switched on again.

Deactivating/activating ESP® (except Mercedes-AMG vehicles)

Important safety notes

i Observe the "Important safety notes" section (▷ page 65).

You can select between the following ESP® statuses:

- ESP® is activated
- ESP® is deactivated.

WARNING

If you deactivate ESP®, ESP® no longer stabilises the vehicle. There is an increased risk of skidding and an accident.

Only deactivate ESP® in the situations described in the following.

The spinning of the wheels results in a cut for better traction on loose surfaces.

It may be best to deactivate ESP® in the following situations:

- when snow chains are used
- in deep snow
- on sand or gravel

i Activate ESP® as soon as the situations described above no longer apply. ESP® will otherwise not be able to stabilise the vehicle if the vehicle starts to skid or a wheel starts to spin.

Deactivating/activating ESP®

You can deactivate or activate ESP® via the on-board computer (▷ page 210).

ESP® deactivated:

The  ESP® OFF warning lamp on the instrument cluster lights up.

ESP® activated:

The  ESP® OFF warning lamp on the instrument cluster goes out.

Characteristics when ESP® is deactivated

If ESP® is deactivated and one or more wheels start to spin, the  ESP® warning lamp in the instrument cluster flashes. In such situations, ESP® will not stabilise the vehicle.

If you deactivate ESP®:

- ESP® no longer improves driving stability
- engine torque is no longer limited and the drive wheels may start to spin
- traction control is still activated
- Active Brake Assist is not available; it is not activated even if you brake firmly with assistance from ESP®
- PRE-SAFE® is not available; it is not activated even if you brake firmly with assistance from ESP®
- STEER CONTROL is no longer active
- ESP® still provides support when you brake firmly

Deactivating/activating ESP® (Mercedes-AMG vehicles)

Important safety notes

- i** Observe the "Important safety notes" section (▷ page 65).

You can select between the following ESP® statuses:

- ESP® is activated
- SPORT handling mode is activated
- ESP® is deactivated

ESP® is activated every time the engine is started, regardless of whether ESP® was deactivated before the engine was switched off.

⚠ WARNING

When SPORT handling mode is activated, there is a greater risk of skidding and accidents.

Only activate SPORT handling mode in the situations described in the following.

⚠ WARNING

If you deactivate ESP®, ESP® no longer stabilises the vehicle. There is an increased risk of skidding and an accident.

Only deactivate ESP® in the situations described in the following.

In the following situations, it may be better to activate SPORT handling mode or deactivate ESP®:

- when snow chains are used
- in deep snow
- on sand or gravel
- on specially designated roads when the vehicle's own oversteering and understeering characteristics are desired

Driving in SPORT handling mode or without ESP® requires a highly qualified and experienced driver.

- i** Activate ESP® as soon as the situations described above no longer apply. ESP® will otherwise not be able to stabilise the vehicle if the vehicle starts to skid or a wheel starts to spin.

Deactivating/activating ESP®



- ▶ **To activate SPORT handling mode:** briefly press button ①. The **SPORT** SPORT handling mode warning lamp on the instrument cluster lights up. The **SPORT handling mode** message appears in the multifunction display.
- ▶ **To deactivate SPORT handling mode:** briefly press button ①. The **SPORT** SPORT handling mode warning lamp on the instrument cluster goes out.
- ▶ **To deactivate ESP®:** press button ① until the **ESP OFF** ESP® OFF warning lamp lights up in the instrument cluster. The **ESP OFF** message appears in the multifunction display.
- ▶ **To activate ESP®:** briefly press button ①. The **ESP OFF** ESP® OFF warning lamp on the instrument cluster goes out. The **ESP** ESP®

ON message appears in the multifunction display.

Characteristics when SPORT handling mode is activated

If SPORT handling mode is activated and one or more wheels start to spin, the  ESP[®] warning lamp on the instrument cluster flashes. In such situations, ESP[®] will stabilise the vehicle only to a limited degree.

When SPORT handling mode is activated:

- ESP[®] improves driving stability only to a limited degree
- traction control is still activated
- the engine's torque is only restricted to a limited degree and the drive wheels may start to spin
The spinning of the wheels results in a cut for better traction on loose surfaces.
- ESP[®] still provides support when you brake firmly

Characteristics when ESP[®] is deactivated

If ESP[®] is deactivated and one or more wheels start to spin, the  ESP[®] warning lamp in the instrument cluster does not flash. In such situations, ESP[®] will not stabilise the vehicle.

If you deactivate ESP[®]:

- ESP[®] no longer improves driving stability
- engine torque is no longer limited and the drive wheels may start to spin
The spinning of the wheels results in a cut for better traction on loose surfaces.
- traction control is still activated
- Active Brake Assist is no longer available; it is not activated even if you brake firmly with assistance from ESP[®]
- PRE-SAFE[®] is no longer available; it is not activated even if you brake firmly with assistance from ESP[®]
- ESP[®] still provides support when you brake firmly

ESP[®] trailer stabilisation

General notes

If your vehicle/trailer combination begins to lurch, ESP[®] assists you in this situation. ESP[®] slows the vehicle down by braking and limiting

the engine output until the vehicle/trailer combination has stabilised.

Important safety notes

WARNING

If road and weather conditions are poor, trailer stabilisation will not be able to prevent the vehicle/trailer combination from swerving. Trailers with a high centre of gravity can tip over before ESP[®] can detect this. There is a risk of an accident.

Always adapt your driving style to the prevailing road and weather conditions.

If your vehicle/trailer combination begins to lurch, you can only stabilise the vehicle/trailer combination by depressing the brake firmly.

ESP[®] trailer stabilisation is active above speeds of approximately 65 km/h.

ESP[®] trailer stabilisation does not work if ESP[®] is deactivated or disabled because of a malfunction.

EBD (electronic brake force distribution)

General information

EBD monitors and controls the brake pressure on the rear wheels to improve driving stability while braking.

Important safety notes

-  Observe the "Important safety notes" section (▷ page 65).

WARNING

If EBD is malfunctioning, the rear wheels can lock, e.g. under full braking. This increases the risk of skidding and an accident.

You should therefore adapt your driving style to the different handling characteristics. Have the brake system checked at a qualified specialist workshop.

Please observe the information on warning and indicator lamps (▷ page 251) (▷ page 251) as well as on display messages (▷ page 221).

ADAPTIVE BRAKE

ADAPTIVE BRAKE enhances braking safety and offers increased braking comfort. In addition to the braking function, ADAPTIVE BRAKE also has the HOLD function (▷ page 174) and hill start assist (▷ page 138).

STEER CONTROL

General information

STEER CONTROL helps you by transmitting a noticeable steering force to the steering wheel in the direction required for vehicle stabilisation. This steering support is provided in particular if:

- both right wheels or both left wheels are on a wet or slippery road surface when you brake
- the vehicle begins to skid

Important safety notes

- ❗ Read the "Important safety notes" section (▷ page 65).

No steering support is provided from STEER CONTROL, if:

- ESP® is malfunctioning
- the steering is malfunctioning

If ESP® is malfunctioning, you will be assisted further by the electrical power steering.

Protection against theft

Immobiliser

The immobiliser prevents your vehicle from being started without the correct key.

- ▶ **To activate with the key:** remove the key from the ignition lock.
- ▶ **To activate with KEYLESS-GO start function or KEYLESS-GO:** switch the ignition off and open the driver's door.
- ▶ **To deactivate:** switch on the ignition.

When leaving the vehicle, always take the key with you and lock the vehicle. Anyone can start the engine if a valid key has been left inside the vehicle.

- ❗ The immobiliser is always deactivated when you start the engine.

ATA (Anti-Theft Alarm system)





- ▶ **To prime:** lock the vehicle with the key or KEYLESS-GO. Indicator lamp ① flashes. The alarm system is primed after approximately 15 seconds.
- ▶ **To deactivate:** unlock the vehicle with the key or KEYLESS-GO.

or

- ▶ Insert the key into the ignition lock.

A visual and audible alarm is triggered if the alarm system is primed and you open:

- a door
- the vehicle with the emergency key element
- the tailgate
- the bonnet

- ▶ **To stop the alarm with the key:** press the  or  button on the key. The alarm stops.

or

- ▶ **Vehicles with KEYLESS-GO start function or KEYLESS-GO:** remove the Start/Stop button from the ignition lock (▷ page 135).
- ▶ Insert the key into the ignition lock. The alarm stops.
- ▶ **To stop the alarm using KEYLESS-GO:** grasp the outside door handle. The key must be outside the vehicle. The alarm stops.

or

- ▶ Press the Start/Stop button on the dashboard. The key must be inside the vehicle. The alarm stops.

The alarm does not switch off, even if you close the open door that has triggered it, for example.

- ❗ If the alarm stays on for more than 30 seconds, the Mercedes-Benz emergency

call system automatically sends a message to the Customer Centre. This is done by means of a text message or a data connection.

The emergency call system sends a message or establishes a data connection provided that:

- you have subscribed to the Mercedes-Benz emergency call system
- the Mercedes-Benz emergency call system has been activated properly
- the necessary mobile phone network is available

Tow-away protection

Function

An audible and visual alarm is triggered if your vehicle's angle of inclination is altered while tow-away protection is primed. This can occur if the vehicle is jacked up on one side, for example.

Switching on

- ▶ Make sure that:
 - the doors are closed
 - the tailgate is closed
 Only then is tow-away protection activated.
- ▶ Lock the vehicle with the key or KEYLESS-GO. Tow-away protection is activated after approximately 60 seconds.

Switching off

- ▶ Unlock the vehicle with the key or KEYLESS-GO.

or

- ▶ Insert the key into the ignition lock. Tow-away protection is switched off automatically.

Deactivating

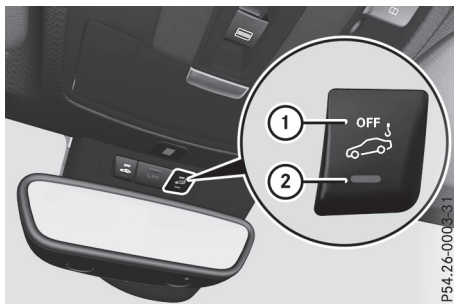

- ▶ Remove the key from the ignition lock.
- or
- ▶ **Vehicles with KEYLESS-GO start function or KEYLESS-GO:** switch off the engine using the Start/Stop button and open the driver's door.
- ▶ Press button ①. Indicator lamp ② lights up briefly.
- ▶ Lock the vehicle with the key or KEYLESS-GO. Tow-away protection is deactivated.

Tow-away protection remains deactivated until:

- the vehicle is unlocked again
- a door is opened and closed again and
- the vehicle is locked again

To prevent a false alarm, deactivate tow-away protection if you lock your vehicle and it:

- is being transported
- is being loaded onto a ferry or car transporter, for example
- is parked on a movable surface, e.g. in a split-level garage

Interior motion sensor

Function

When the interior motion sensor is switched on, a visual and audible alarm is triggered if movement is detected in the vehicle interior. This can occur if someone reaches into the vehicle interior, for example.

Switching on

- ▶ Make sure that:

- the side windows are closed
- the panorama sliding sunroof is closed
- there are no objects, e.g. mascots, hanging on the rear-view mirror or on the grab handles on the roof trim

This will prevent false alarms.

- ▶ Make sure that:
 - the doors are closed
 - the panorama sliding sunroof is closed
 - the tailgate is closed
 Only then is the interior motion sensor activated.
- ▶ Lock the vehicle with the key or KEYLESS-GO. The interior motion sensor is primed after approximately 30 seconds.

Switching off

- ▶ Unlock the vehicle with the key or KEYLESS-GO.

or

- ▶ Insert the key into the ignition lock.

or

- ▶ Press the Start/Stop button.

The key must be in the vehicle.
The interior motion sensor is automatically switched off.

- ▶ Press button ①.
Indicator lamp ② flashes several times in rapid succession.
- ▶ Lock the vehicle with the key or KEYLESS-GO. The interior motion sensor is deactivated.

The interior motion sensor remains deactivated until:

- the vehicle is unlocked again and
- a door is opened and closed again and
- the vehicle is locked again

To prevent a false alarm, deactivate the interior motion sensor if you lock your vehicle and:

- people or animals remain in the vehicle
- the panorama sliding sunroof remains open
- the side windows remain open

- ▶ **i UK only:** your vehicle is equipped with a double-lock function. The doors cannot be opened from the inside if the vehicle has been locked with the key (▷ page 83). Deactivate the interior motion sensor before you lock the vehicle with the key. The doors can then be opened from the inside after the vehicle has been locked from the outside with the key. Observe the "Important safety notes" (▷ page 83).

Deactivating



- ▶ Remove the key from the ignition lock.

or

- ▶ **Vehicles with KEYLESS-GO start function or KEYLESS-GO:** switch off the engine using the Start/Stop button and open the driver's door.

Keys

Important safety notes

 **WARNING**

If children are left unsupervised in the vehicle, they could:

- open doors, thereby endangering other persons or road users
- get out and be struck by oncoming traffic
- operate vehicle equipment and become trapped, for example

In addition, the children could also set the vehicle in motion, for example, if they:

- release the parking brake
- shift the automatic transmission out of park position **P** or shift manual transmission into neutral
- start the engine.

There is a risk of an accident and injury.

When leaving the vehicle, always take the key with you and lock the vehicle. This also applies to mobile phones if the "Digital Car Key in smartphone" function is activated via the Mercedes me connect web app. Never leave children and animals unattended in the vehicle.

Keep the keys out of the reach of children. This also applies to mobile phones if the "Digital Car Key in smartphone" function is activated via the Mercedes me connect web app.

 **WARNING**

If you attach heavy or large objects to the key, the key could be unintentionally turned in the ignition lock. This could cause the engine to be switched off. There is a risk of an accident.

Do not attach any heavy or large objects to the key. Remove any bulky keyrings before inserting the key into the ignition lock.

-  **!** Keep the key away from strong magnetic fields. Otherwise, the remote control function could be affected.

Strong magnetic fields can occur in the vicinity of powerful electrical installations.

Do not keep the key:

- with electronic devices, e.g. a mobile phone or another key
- with metallic objects, e.g. coins or metal foil
- inside metallic objects, e.g. a metal case

Vehicles with KEYLESS-GO start function: do not keep the key in the luggage compartment. Otherwise, the key may not be detected, e.g. when starting the engine using the Start/Stop button.

United Kingdom only:

 **WARNING**

When the double locks are activated, the doors can no longer be opened from the inside. People in the vehicle can no longer get out, e.g. in hazardous situations. There is a risk of injury.

Therefore, do not leave any people unsupervised in the vehicle, particularly children, elderly people or people in need of special assistance. Do not activate the double lock when people are in the vehicle.

If the vehicle has been locked from the outside, the double lock function is activated as standard. It is then not possible to open the doors from inside the vehicle. You can deactivate the double lock function by deactivating the interior motion sensor (> page 75). The doors can then be opened from the inside after the vehicle has been locked from the outside. You can open the rear doors from inside the vehicle if they are not secured by the child-proof locks (> page 64). Opening a door from the inside will trigger the anti-theft alarm system. Switch off the alarm (> page 73).

Key functions

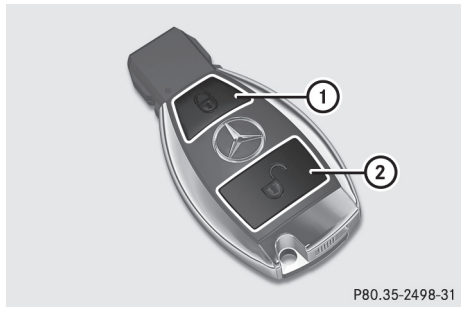

- ① Locks the vehicle
- ② Unlocks the vehicle

► **To unlock centrally:** press the button.

If you do not open the vehicle within approximately 40 seconds of unlocking:

- the vehicle locks again
- anti-theft protection is reactivated

► **To lock:** press the button.

The key centrally locks/unlocks:

- the doors
- the tailgate
- the fuel filler flap

During unlocking, the indicators flash once. During locking, they flash three times.

When the locator lighting is activated via the multimedia system, it lights up when it is dark after the vehicle is unlocked with the remote control (see the Digital Owner's Manual).

You can also set an audible signal to confirm that the vehicle has been locked. The audible signal can be activated or deactivated using the on-board computer (► page 213).

KEYLESS-GO

General notes

Bear in mind that the engine can be started by any of the vehicle occupants if there is a key in the vehicle.

Locking and unlocking

You can start, lock or unlock the vehicle using KEYLESS-GO. To do this, you need to carry the key with you. You can combine the KEYLESS-GO

functions with the functions of a conventional key. Unlock the vehicle using KEYLESS-GO, for instance, and lock it using the button on the key.

The driver's door and the door on which the handle is used must both be closed. The key must be outside the vehicle. When locking or unlocking with KEYLESS-GO, the distance between the key and the corresponding door handle must not be greater than one metre.

A check that periodically establishes a radio connection between the vehicle and the key determines whether a valid key is in or in the direct vicinity of the vehicle. This occurs, for example:

- while starting the engine
- while driving
- when the external door handles are touched
- during convenience closing

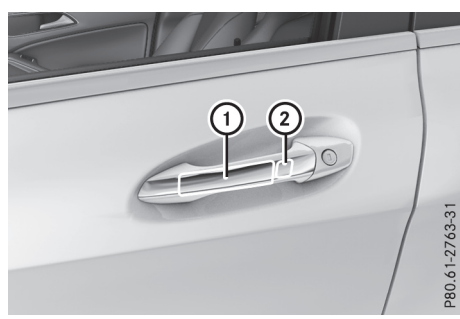

► **To unlock the vehicle:** touch the inner surface of the door handle.

► **To lock the vehicle:** touch sensor surface ① or ②.

Make sure that you do not touch the inner surface of the door handle.

► **Convenience closing feature:** touch recessed sensor surface ② for an extended period.

Further information on the convenience closing feature (► page 90).

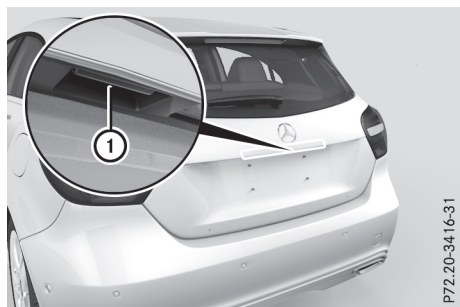

P72.20-34 16-31

- ▶ **To unlock the tailgate:** pull tailgate handle ①.



Activating and deactivating



If you do not intend to use the vehicle for an extended period of time, you can deactivate KEYLESS-GO. The key will then use very little power, thereby conserving battery power. For the purposes of activation or deactivation, the vehicle does not have to be nearby.

- ▶ **To deactivate:** press the  button on the key twice in rapid succession. The indicator light on the key flashes twice briefly then one long flash, then KEYLESS-GO is deactivated (▷ page 79).
 - ▶ **To activate:** press any button on the key.
- or
- ▶ Insert the key into the ignition lock. KEYLESS-GO and all its associated features are available again.

Changing the settings of the locking system

You can change the settings of the locking system. This means that only the driver's door and the fuel filler flap are unlocked when the vehicle is unlocked. This is useful if you frequently travel alone.

- ▶ **To change the setting:** press and hold down the  and  buttons simultaneously for about six seconds until the battery indicator lamp flashes twice (▷ page 79).



If the setting of the locking system is changed within the signal range of the vehicle, pressing the  or  button:

- locks or
- unlocks the vehicle

The key now functions as follows:

- ▶ **To unlock:** press the  button once.
- ▶ **To unlock centrally:** press the  button twice.
- ▶ **To lock centrally:** press the  button.

The KEYLESS-GO function is changed as follows:

- ▶ **To unlock the driver's door:** touch the inner surface of the door handle on the driver's door.
- ▶ **To unlock centrally:** touch the inner surface of the door handle on the front-passenger door or the rear door.
- ▶ **To lock centrally:** touch the outer sensor surface on one of the door handles.
- ▶ **To restore the factory settings:** press and hold down the  and  buttons simultaneously for approximately six seconds until the battery check lamp flashes twice (▷ page 79).



Emergency key element

General notes

If the vehicle can no longer be unlocked with the key or KEYLESS-GO, use the emergency key element.

If you use the emergency key element to unlock and open the driver's door or the tailgate, the anti-theft alarm system will be triggered (▷ page 73).

There are several ways to deactivate the alarm:

- ▶ **To deactivate the alarm with the key:** press the  or  button on the key.
- or
- ▶ Insert the key into the ignition lock.
- or
- ▶ **To deactivate the alarm with KEYLESS-GO:** press the Start/Stop button in the ignition lock. The key must be in the vehicle.
- or
- ▶ Lock or unlock the vehicle using KEYLESS-GO. The key must be outside the vehicle.

If you unlock the vehicle using the emergency key element, the fuel filler flap will not be unlocked automatically.

- ▶ **To unlock the fuel filler flap:** insert the key into the ignition lock.

Removing the emergency key element

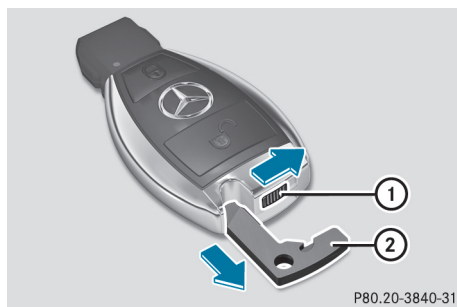

- ▶ Push release catch ① in the direction of the arrow and, at the same time, remove emergency key element ② from the key.

Further information about:

- Unlocking the driver's door (▶ page 85)
- Locking the vehicle (▶ page 85)

Inserting the emergency key element

- ▶ Push emergency key element ② completely into the key until it engages and release catch ① is back in its basic position.

Key battery

Important safety notes

WARNING

Batteries contain toxic and corrosive substances. If batteries are swallowed, it can result in severe health problems. There is a risk of fatal injury.

Keep batteries out of the reach of children. If a battery is swallowed, seek medical attention immediately.

Environmental note



Batteries contain pollutants. It is illegal to dispose of them with the household rubbish. They must be collected separately and disposed of in an

environmentally responsible recycling system.







Dispose of batteries in an environmentally responsible manner. Take discharged batteries to a qualified specialist workshop or to a collection point for used batteries.

Mercedes-Benz recommends that you have the battery replaced at a qualified specialist workshop.

Checking the battery



- ▶ Press the  or  button. The battery is working properly if battery check lamp ① lights up briefly. The battery is discharged if battery check lamp ① does not light up briefly.
- ▶ Replace the battery (▶ page 79).
- i** If the key battery is checked within the signal reception range of the vehicle, pressing the  or  button:
 - locks or
 - unlocks the vehicle
- i** You can obtain a battery from any qualified specialist workshop.

Replacing the battery

You require a CR 2025 3 V button cell battery.



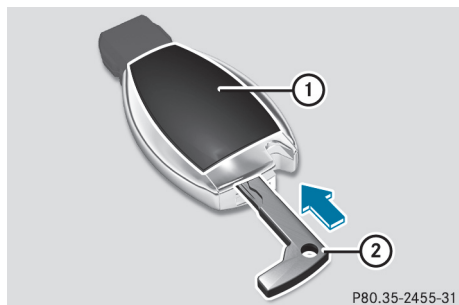

- ▶ Take the emergency key element out of the key (▶ page 78).

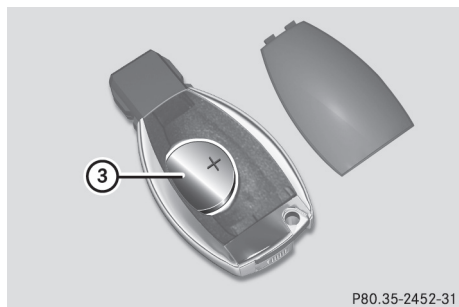

- ▶ Press emergency key element (2) into the opening in the key in the direction of the arrow until battery tray cover (1) opens. When doing so, do not hold cover (1) shut.
- ▶ Remove battery tray cover (1).



- ▶ Repeatedly tap the key against your palm until battery (3) falls out.
- ▶ Insert the new battery with the positive terminal facing upwards. Use a lint-free cloth to do so.
- ▶ Make sure that the surface of the battery is free of lint, grease and other contamination.
- ▶ Insert the front tabs of battery tray cover (1) and then press to close it.
- ▶ Insert the emergency key element into the key (▷ page 79).
- ▶ Check the function of all key buttons on the vehicle.

Problems with the key	
Problem	Possible causes/consequences and ► Solutions
You can no longer lock or unlock the vehicle using the key.	<p>The key battery is weak or discharged.</p> <p>► Vehicles without KEYLESS-GO or KEYLESS-GO start function: try again to lock/unlock the vehicle using the remote control function of the key. Point the tip of the key at the driver's door handle from close range and press the  or  button.</p> <p>If this does not work:</p> <ul style="list-style-type: none"> ► Check the key battery (▷ page 79) and replace if necessary (▷ page 79). ► Unlock (▷ page 85) or lock (▷ page 85) the vehicle using the emergency key element.
	<p>There is interference from a powerful source of radio waves.</p> <p>► Vehicles without KEYLESS-GO or KEYLESS-GO start function: try again to lock/unlock the vehicle using the remote control function of the key. Point the tip of the key at the driver's door handle from close range and press the  or  button.</p> <p>If this does not work:</p> <ul style="list-style-type: none"> ► Unlock (▷ page 85) or lock (▷ page 85) the vehicle using the emergency key element.
	<p>The key is faulty.</p> <ul style="list-style-type: none"> ► Unlock (▷ page 85) or lock (▷ page 85) the vehicle using the emergency key element. ► Have the key checked at a qualified specialist workshop.
You can no longer lock or unlock the vehicle using KEYLESS-GO.	<p>The key battery is weak or discharged.</p> <ul style="list-style-type: none"> ► Check the key battery (▷ page 79) and replace if necessary (▷ page 79). <p>If this does not work:</p> <ul style="list-style-type: none"> ► Unlock (▷ page 85) or lock (▷ page 85) the vehicle using the emergency key element.
	<p>There is interference from a powerful source of radio waves.</p> <ul style="list-style-type: none"> ► Unlock (▷ page 85) or lock (▷ page 85) the vehicle using the emergency key element.

Problem	Possible causes/consequences and ► Solutions
	<p>There is a fault with KEYLESS-GO.</p> <ul style="list-style-type: none"> ► Lock or unlock the vehicle using the remote control function of the key. ► Have the vehicle and key checked at a qualified specialist workshop. <p>If the vehicle cannot be locked or unlocked even using the remote control function:</p> <ul style="list-style-type: none"> ► Unlock (▷ page 85) or lock (▷ page 85) the vehicle using the emergency key element. ► Have the vehicle and key checked at a qualified specialist workshop.
<p>The engine cannot be started using the key.</p>	<p>The on-board voltage is too low</p> <ul style="list-style-type: none"> ► Switch off non-essential consumers, e.g. seat heating or interior lighting, and try to start the engine again. <p>If this does not work:</p> <ul style="list-style-type: none"> ► Check the starter battery and charge it if necessary (▷ page 306). <p>or</p> <ul style="list-style-type: none"> ► Jump-start the vehicle (▷ page 307). <p>or</p> <ul style="list-style-type: none"> ► Consult a qualified specialist workshop.
<p>The engine cannot be started using the Start/Stop button. The key is in the vehicle.</p>	<p>The vehicle is locked.</p> <ul style="list-style-type: none"> ► Unlock the vehicle and try to start the vehicle again. <p>The key battery is weak or discharged.</p> <ul style="list-style-type: none"> ► Check the key battery (▷ page 79) and replace if necessary (▷ page 79). <p>If this does not work:</p> <ul style="list-style-type: none"> ► Start your vehicle with the key in the ignition lock. <p>There is interference from a powerful source of radio waves.</p> <ul style="list-style-type: none"> ► Start your vehicle with the key in the ignition lock.
<p>You have lost a key.</p>	<ul style="list-style-type: none"> ► Have the key deactivated at a qualified specialist workshop. ► Report the loss immediately to the vehicle insurers. ► If necessary, have the locks changed as well.
<p>You have lost the emergency key element.</p>	<ul style="list-style-type: none"> ► Report the loss immediately to the vehicle insurers. ► If necessary, have the locks changed as well.

Doors

Important safety notes

⚠ WARNING

If children are left unsupervised in the vehicle, they could:

- open doors, thereby endangering other persons or road users
- get out and be struck by oncoming traffic
- operate vehicle equipment and become trapped, for example

In addition, the children could also set the vehicle in motion, for example, if they:

- release the parking brake
- shift the automatic transmission out of park position **P** or shift manual transmission into neutral
- start the engine.

There is a risk of an accident and injury.

When leaving the vehicle, always take the key with you and lock the vehicle. This also applies to mobile phones if the "Digital Car Key in smartphone" function is activated via the Mercedes me connect web app. Never leave children and animals unattended in the vehicle.

Keep the keys out of the reach of children. This also applies to mobile phones if the "Digital Car Key in smartphone" function is activated via the Mercedes me connect web app.

Stow luggage or loads preferably in the luggage compartment. Observe the loading guidelines (▷ page 271).

United Kingdom only:**⚠ WARNING**

When the double locks are activated, the doors can no longer be opened from the inside. People in the vehicle can no longer get out, e.g. in hazardous situations. There is a risk of injury.

Therefore, do not leave any people unsupervised in the vehicle, particularly children, elderly people or people in need of special assis-

tance. Do not activate the double lock when people are in the vehicle.

If the vehicle has been locked with the key, the double lock function is activated as standard. It is then not possible to open the doors from inside the vehicle. You can deactivate the double lock function by deactivating the interior motion sensor (▷ page 75). The doors can then be opened from the inside after the vehicle has been locked from the outside. You can open the rear doors from inside the vehicle if they are not secured by the child-proof locks (▷ page 64). Opening a door from the inside will trigger the anti-theft alarm system. Switch off the alarm (▷ page 73).

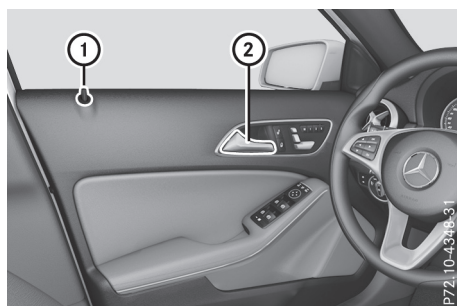
Unlocking and opening the doors from the inside

- ▶ Pull door handle ②.
If the door is locked, locking knob ① pops up. The door is unlocked and opens.

For all countries except the United Kingdom:

You can open a door from inside the vehicle even if it has been locked. You can only open the rear side doors from inside the vehicle if they are not secured by the child-proof locks (▷ page 64).

If the vehicle has previously been locked with the key from the outside, opening a door from the inside will trigger the anti-theft alarm system. Switch off the alarm (▷ page 73).

United Kingdom only:**⚠ WARNING**

When the double locks are activated, the doors can no longer be opened from the inside. People in the vehicle can no longer get

out, e.g. in hazardous situations. There is a risk of injury.

Therefore, do not leave any people unsupervised in the vehicle, particularly children, elderly people or people in need of special assistance. Do not activate the double lock when people are in the vehicle.

If the vehicle has been locked from the outside, the double lock function is activated as standard. It is then not possible to open the doors from inside the vehicle. You can deactivate the double lock function by deactivating the interior motion sensor (▷ page 75). The doors can then be opened from the inside after the vehicle has been locked from the outside. You can open the rear doors from inside the vehicle if they are not secured by the child-proof locks (▷ page 64). The anti-theft alarm system is triggered if the door is opened from the inside. Switch off the alarm (▷ page 73).

Centrally locking and unlocking the vehicle from the inside

You can centrally lock or unlock the vehicle from the inside. This can be useful if you wish to lock the vehicle before pulling away, for example.

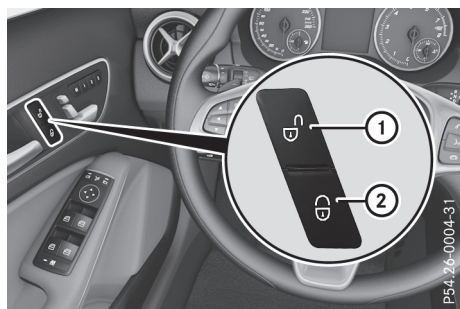

► **To unlock:** press button ①.

► **To lock:** press button ②.

If all the doors and the tailgate are closed, the vehicle locks.

This does not lock or unlock the fuel filler flap.

You cannot unlock the vehicle centrally from the inside if the vehicle has been locked with the key or KEYLESS-GO.

For all countries except the United Kingdom:

You can open a door from inside the vehicle even if it has been locked.

If the vehicle has previously been locked with the key from the outside, opening a door from the inside will trigger the anti-theft alarm system. Switch off the alarm (▷ page 73).

You can open the rear doors from inside the vehicle if they are not secured by the child-proof locks (▷ page 64).

When a locked door is opened from inside the vehicle, the previous unlocking process will be observed if the vehicle has been:

- locked with the locking button for the central locking or
- locked automatically

The vehicle will be fully unlocked if it had previously been fully unlocked. Only the door that has been opened from the inside is unlocked if only the driver's door had previously been unlocked.

United Kingdom only:

If the vehicle has been locked with the key, the double lock function is activated as standard. It is then not possible to open the doors from inside the vehicle. You can deactivate the double lock function by deactivating the interior motion sensor (▷ page 75). The doors can then be opened from the inside after the vehicle has been locked from the outside. You can open the rear doors from inside the vehicle if they are not secured by the child-proof locks (▷ page 64). The anti-theft alarm system is triggered if the door is opened from the inside. Switch off the alarm (▷ page 73).

When a locked door is opened from inside the vehicle, the previous unlocking process will be observed if the vehicle has been:

- locked with the locking button for the central locking or
- locked automatically

The vehicle will be fully unlocked if it had previously been fully unlocked. Only the door that has been opened from the inside is unlocked if only the driver's door had previously been unlocked.

Automatic locking feature

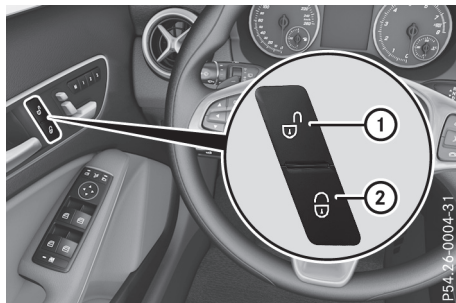

- ▶ **To deactivate:** press and hold button ① for approximately five seconds until a tone sounds.
- ▶ **To activate:** press and hold button ② for approximately five seconds until a tone sounds.

If you press one of the two buttons and do not hear a tone, the relevant setting has already been selected.

The vehicle is locked automatically when the ignition is switched on and the wheels are turning.

You could therefore be locked out if:

- the vehicle is being pushed
- the vehicle is being towed
- the vehicle is being tested on a dynamometer

You can also activate and deactivate the automatic locking function using the on-board computer (▷ page 213).

Unlocking the driver's door (emergency key element)

If the vehicle can no longer be unlocked with the key or KEYLESS-GO, use the emergency key element.

If you use the emergency key element to unlock and open the driver's door, the anti-theft alarm system will be triggered. Switch off the alarm (▷ page 73).

- ▶ Take the emergency key element out of the key (▷ page 78).
- ▶ Insert the emergency key element into the lock of the driver's door as far as it will go.

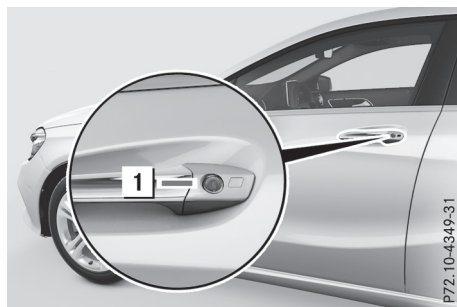

- ▶ Turn the emergency key element anti-clockwise as far as it will go to position 1. On right-hand-drive vehicles, turn the emergency key element clockwise. The door is unlocked.
- ▶ Turn the emergency key element back and remove it.
- ▶ Insert the emergency key element into the key (▷ page 79).

Locking the vehicle (emergency key element)

If the vehicle can no longer be locked with the key or KEYLESS-GO, use the emergency key element.

- ▶ Open the driver's door.
- ▶ Close the front-passenger door, the rear doors and the tailgate.
- ▶ Press the locking button on the driver's door (▷ page 84).
- ▶ Check whether the locking knobs on the front-passenger door and the rear doors are still visible. Press the locking knobs down by hand if necessary.
- ▶ Close the driver's door.
- ▶ Take the emergency key element out of the key (▷ page 78).
- ▶ Insert the emergency key element into the lock of the driver's door as far as it will go.

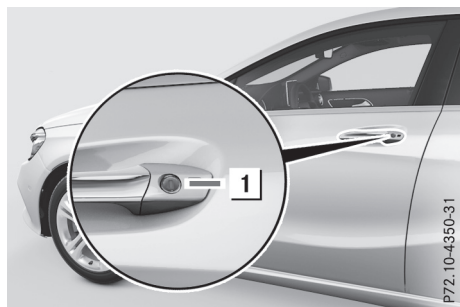

- ▶ Turn the emergency key element clockwise as far as it will go to position **1**.
On right-hand-drive vehicles, turn the emergency key element anti-clockwise.
- ▶ Turn the emergency key element back and remove it.
- ▶ Make sure that the doors and the tailgate are locked.
- ▶ Insert the emergency key element into the key (▷ page 79).

i If you lock the vehicle as described above, the fuel filler flap is not locked. The anti-theft alarm system is not primed.

Luggage compartment

Important safety notes

WARNING

Combustion engines emit poisonous exhaust gases such as carbon monoxide. If the tailgate is open when the engine is running, particularly if the vehicle is moving, exhaust fumes could enter the passenger compartment. There is a risk of poisoning.

Turn off the engine before opening the tailgate. Never drive with the tailgate open.

WARNING

If objects, luggage or loads are not secured or not secured sufficiently, they could slip, tip over or be flung around and thereby hit vehicle occupants. There is a risk of injury, especially when braking or abruptly changing directions. Always store objects so that they cannot be flung around. Secure objects, luggage or

loads against slipping or tipping before the journey.

! The tailgate swings upwards and to the rear when opened. Therefore, make sure that there is sufficient clearance above and behind the tailgate.

You will find details on the tailgate opening dimensions in the "Vehicle data" section (▷ page 340).

Stow luggage or loads preferably in the luggage compartment. Observe the loading guidelines (▷ page 271).

Do not leave the key in the luggage compartment. If you do so, you could lock yourself out.

The tailgate can be:

- opened and closed manually from outside
- opened from the inside using the emergency release

Tailgate obstruction detection with reversing function

On vehicles with EASY-PACK tailgate, the tailgate is equipped with automatic obstacle recognition with a reversing feature. If a solid object blocks or restricts the tailgate when automatically opening or closing, the tailgate is stopped. If the tailgate is stopped during the closing process, the tailgate automatically opens again slightly. The automatic obstacle detection with reversing function is only an aid. It is not a substitute for your attention when opening and closing the tailgate.

WARNING

The reversing function does not react:

- to soft, light and thin objects, e.g. fingers
- over the last 8 mm of the closing path

In these situations in particular, the reversing function cannot prevent someone being trapped. There is a risk of injury.

When closing, make sure that no body parts are in the closing area.

If someone is trapped:

- press the  button on the key or
- pull or press the remote operating switch on the driver's door or

- press the closing or Stop button on the tailgate or
- pull the handle on the tailgate

Opening and closing manually

Opening

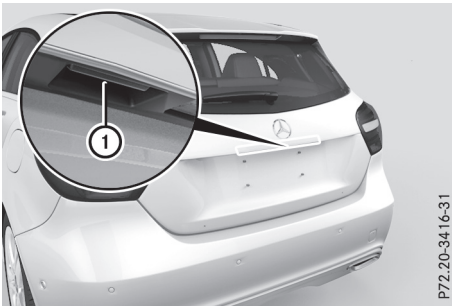

P72.20-3416-31

- ▶ Press the  button on the key.
- ▶ Pull handle ①.
- ▶ Raise the tailgate.

Closing

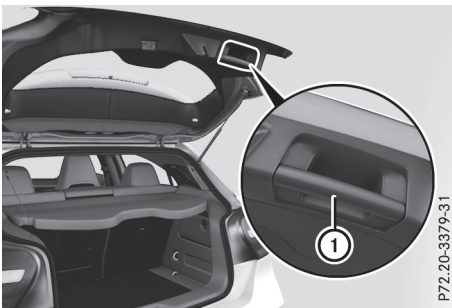

P72.20-3379-31

- ▶ Pull the tailgate down using handle ①.
- ▶ Let the tailgate drop into the lock.
- ▶ If necessary, lock the vehicle with the  button on the key or with KEYLESS-GO.

Opening and closing automatically from the inside

Important safety notes

WARNING

Parts of the body could become trapped during automatic closing of the tailgate. Moreover, people, e.g. children, may be standing in the closing area or may enter the closing area during the closing process. There is a risk of injury.

Make sure that nobody is in the vicinity of the closing area during the closing process.

Use one of the following options to stop the closing process:

- press the  button on the key
- pull or press the remote operating switch on the driver's door
- press the closing or locking button on the tailgate
- pull the handle on the tailgate

! The tailgate swings upwards and to the rear when opened. Therefore, make sure that there is sufficient clearance above and behind the tailgate.

You will find details on the tailgate opening dimensions in the "Vehicle data" section (> page 340).

Opening/closing automatically

You can open the tailgate from the driver's seat when the vehicle is stationary and unlocked.

It is possible to close the tailgate from the driver's seat only in vehicles with the EASY-PACK tailgate.

- ▶ **To open:** pull remote operating switch ① for the tailgate until the tailgate opens.
- ▶ **To close:** turn the key to position ① or ② in the ignition lock (> page 135).
- ▶ Press and hold remote operating switch ① for the tailgate until the tailgate is completely closed.

Limiting the opening angle of the tailgate

General notes

- ❗ Make sure there is sufficient clearance to open the tailgate fully when setting the opening angle. The tailgate could otherwise be damaged. Ideally, set the opening angle outside.

You can limit the opening angle of the tailgate. This could be useful, for example, if there is insufficient space above the tailgate. It is possible to limit the tailgate in the top half of its opening range.

To open the tailgate fully, pull the handle on the outside of the tailgate again after it has stopped automatically. This does not delete the stored position.

Activating

- ▶ **To open the tailgate:** pull the handle on the tailgate.
- ▶ **To stop the opening procedure at the desired position:**
 - press the closing button in the tailgate, or
 - pull the handle on the outside of the tailgate again or
 - press the tailgate button on the key.
- ▶ **To store the position:** press and hold the closing button on the tailgate until you hear a short tone. The opening angle limiter is activated. The tailgate then stops in the stored position when opened.

Deactivating

- ▶ Press and hold the closing button on the tailgate until two short tones sound.

Tailgate emergency release

General notes

- ❗ The tailgate swings upwards and to the rear when opened. Therefore, make sure that there is sufficient clearance above and behind the tailgate.

You will find details on the tailgate opening dimensions in the "Vehicle data" section (▷ page 340).

If the tailgate can no longer be unlocked:

- using the key, or
- using the remote operating switch in the door control panel:

Use the emergency release on the inside of the tailgate.

You can reach the emergency release via the luggage compartment.

Opening

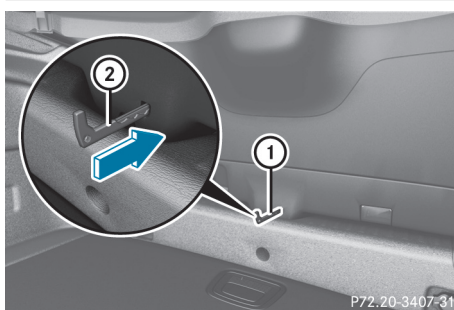

- ▶ Fold the rear seat backrest forwards (▷ page 274).
- ▶ Take the emergency key element out of the key (▷ page 79).
- ▶ Insert emergency key element ② into opening ① in the trim and push it in.
- ▶ Open the tailgate.
- ▶ Insert the emergency key element into the key (▷ page 79).

Side windows

Important safety notes

⚠ WARNING

While opening the side windows, body parts could become trapped between the side window and the door frame as the side window moves. There is a risk of injury.

Make sure that nobody touches the side window during the opening procedure. If somebody becomes trapped, release the switch or pull the switch to close the side window again.

⚠ WARNING

While closing the side windows, body parts in the closing area could become trapped. There is a risk of injury.

When closing make sure that no parts of the body are in the closing area. If somebody becomes trapped, release the switch or press the switch to open the side window again.

⚠ WARNING

If children operate the side windows they could become trapped, particularly if they are left unsupervised. There is a risk of injury.

Activate the override feature for the rear side windows. When leaving the vehicle, always take the key with you and lock the vehicle. Never leave children unattended in the vehicle.

Side window reversing feature

The side windows are equipped with an automatic reversing feature. If a solid object blocks or restricts a side window from travelling upwards during the automatic closing process, the side window opens again automatically. During the manual closing process, the side window only opens again automatically after the corresponding switch is released. The automatic reversing feature is only an aid and is no substitute for your attention when closing a side window.

⚠ WARNING

The reversing function does not react:

- to soft, light and thin objects, e.g. small fingers
- while resetting

This means that the reversing feature cannot prevent someone being trapped in these situations. There is a risk of injury.

When closing, make sure that no parts of the body are in the closing area. If someone becomes trapped, press the switch to open the side window again.

Opening and closing the side windows

The switches for all side windows are located on the driver's door. There is also a switch on each door for the corresponding side window.

The switches on the driver's door take precedence.

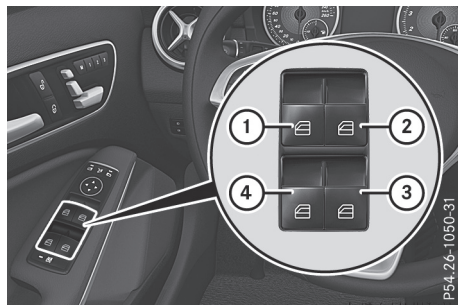

- ① Front left
- ② Front right
- ③ Rear right
- ④ Rear left

▶ Turn the key to position **1** or **2** in the ignition lock (▷ page 135).

▶ **To open manually:** press and hold the corresponding switch.

▶ **To open fully:** press the button beyond the pressure point and release it. Automatic operation is started.

▶ **To close manually:** pull the corresponding button and hold it.

▶ **To close fully:** pull the button beyond the pressure point and release it. Automatic operation is started.

▶ **To interrupt automatic operation:** press/pull the corresponding switch again.

i If you press/pull the switch beyond the pressure point, automatic operation is started in the corresponding direction. You can stop automatic operation by pressing/pulling again.

i You can continue to operate the side windows after switching off the engine or removing the key. This function remains active for five minutes or until the driver's or front-passenger door is opened.

- i** The side windows cannot be operated from the rear when the override feature for the side windows is activated (▷ page 65).

Convenience opening feature

Vehicles with KEYLESS-GO or KEYLESS-GO start function: you can ventilate the vehicle before you start driving.

The key can also be used to carry out the following functions simultaneously:

- unlock the vehicle
- open the side windows
- open the panorama sliding sunroof and the roller sunblind

The convenience opening feature can be operated only using the key.



The "Convenience opening" feature is also available when the vehicle is unlocked.

► **Vehicles with KEYLESS-GO or KEYLESS-GO start function:** for the following operations, point the tip of the key at the handle on the driver's door. The key must be close to the driver's door handle.

- i** **Vehicles with KEYLESS-GO or KEYLESS-GO start function:** the key must be in close proximity to the vehicle.

► Press and hold the  button until the side windows and the panorama sunroof are in the desired position.

If the roller sunblind of the panorama sliding sunroof is closed, the roller sunblind is opened first.

- Press and hold the  button once more until the panorama sliding sunroof reaches the desired position.
- **To interrupt convenience opening:** release the  button.

Convenience closing feature

Important safety notes

WARNING

When the convenience closing feature is operating, parts of the body could become trapped in the closing area of the side window and the sliding sunroof. There is a risk of injury.

Observe the complete closing procedure when the convenience closing feature is operating. When closing make sure that no parts of the body are in the closing area.

Vehicles with KEYLESS-GO or KEYLESS-GO start function: you can do the following at the same time:

- lock the vehicle
- close the side windows
- close the panorama sliding sunroof

On vehicles with a panorama sliding sunroof, you can then close the roller sunblind.

- i** Notes on the automatic reversing function for:

- the side windows (▷ page 89)
- the panorama sliding sunroof (▷ page 93)
- the roller sunblind (▷ page 94)

Using the key

► **Vehicles with KEYLESS-GO or KEYLESS-GO start function:** for the following operations, point the tip of the key at the handle on the driver's door. The key must be close to the driver's door handle.

- i** **Vehicles with KEYLESS-GO or KEYLESS-GO start function:** the key must be in close proximity to the vehicle.

► Press and hold the  button until the side windows and the panorama sliding sunroof are fully closed.

► Make sure that all the side windows and the panorama sliding sunroof are closed.

On vehicles with a panorama sliding sunroof:

► Press and hold the  button again until the roller sunblind of the panorama sliding sunroof closes.

► **To interrupt convenience closing:** release the  button.

Using KEYLESS-GO

The driver's door and the door at which the handle is used must both be closed. The key must be outside the vehicle. The gap between the key and the corresponding door handle should not be greater than 1 m.



P80.61-2762-31

- ▶ Touch recessed sensor surface ① on the door handle until the side windows and the panorama sliding sunroof are fully closed.

i Make sure you touch only recessed sensor surface ①.

- ▶ Make sure that all the side windows are closed.
- ▶ Make sure that all the side windows and the panorama sliding sunroof are closed.

On vehicles with a panorama sliding sunroof:

- ▶ Touch recessed sensor surface ① on the door handle again until the roller sunblind of the panorama sliding sunroof closes.

- ▶ **To interrupt convenience closing:** release recessed sensor surface ① on the door handle.

Resetting the side windows

If a side window can no longer be closed fully, you must reset it.

- ▶ Close all doors.
- ▶ Turn the key to position **1** or **2** in the ignition lock (▷ page 135).
- ▶ Pull the corresponding switch on the door control panel until the side window is completely closed (▷ page 89).
- ▶ Hold the switch for an additional second.

If the side window opens again slightly:

- ▶ Immediately pull the corresponding switch on the door control panel until the side window is completely closed (▷ page 89).
- ▶ Hold the switch for an additional second.
- ▶ If the corresponding side window remains closed after the button has been released, the side window has been reset correctly. If this is not the case, repeat the steps above.

Problems with the side windows

WARNING

If you close a side window again immediately after it has been blocked or reset, the side window closes with increased or maximum force. The reversing function is then not active. Parts of the body could be trapped in the closing area in the process. This poses an increased risk of injury or even fatal injury.

Make sure that no parts of the body are in the closing area. To stop the closing process, release the switch or push the switch again to reopen the side window.

Problem	Possible causes/consequences and ► Solutions
A side window cannot be closed because it is blocked by objects, e.g. leaves in the window guide.	<ul style="list-style-type: none"> ► Remove the objects. ► Close the side window.
A side window cannot be closed and you cannot see the cause.	<p>If a side window is obstructed during closing and reopens again slightly:</p> <ul style="list-style-type: none"> ► Immediately after the window is obstructed, pull the corresponding switch again until the side window has closed. The side window is closed with increased force. <p>If a side window is obstructed again during closing and reopens again slightly:</p> <ul style="list-style-type: none"> ► Immediately after the window is obstructed, pull the corresponding switch again until the side window has closed. The side window is closed without the automatic reversing feature.
The side windows cannot be opened or closed using the convenience opening/closing feature.	<p>The key battery is weak or discharged.</p> <ul style="list-style-type: none"> ► Check the key battery (▷ page 79) and replace if necessary (▷ page 79).

Panorama sliding sunroof

Important safety notes

In the following section, the term "sliding sunroof" refers to the panorama sliding sunroof.

WARNING

While opening and closing the sliding sunroof, body parts in close proximity could become trapped. There is a risk of injury.

Make sure that no body parts are in close proximity during the opening and closing procedures.

If somebody becomes trapped:

- release the switch immediately, or
- during automatic operation, press the switch briefly in any direction

The opening or closing procedure will be stopped.

WARNING

If children operate the sliding sunroof they could become trapped, particularly if they are left unsupervised. There is a risk of injury.

When leaving the vehicle, always take the key with you and lock the vehicle. Never leave children unattended in the vehicle.

WARNING

At high speeds the raised sliding sunroof automatically lowers slightly at the rear. This could trap you or other persons. There is a risk of injury. Make sure that nobody reaches into the sweep of the sliding sunroof whilst the vehicle is in motion.

If somebody becomes trapped, immediately pull back the sliding sunroof switch. The sliding sunroof lifts during opening.

 Only open the panorama sliding sunroof if it is free of snow and ice. Otherwise, malfunctions may occur.

Do not allow anything to protrude from the sliding sunroof. Otherwise, the seals could be damaged.

- i** Resonance noises can occur in addition to the usual airflow noises when the sliding sunroof is open. They are caused by minor pressure fluctuations in the vehicle interior. Change the position of the sliding sunroof or open a side window slightly to reduce or eliminate these noises.

Reversing feature of the sliding sunroof

In the following section, the term "sliding sunroof" refers to the panorama sliding sunroof.

The sliding sunroof is equipped with an automatic reversing function. If a solid object blocks or restricts the sliding sunroof during the closing process, the sliding sunroof opens again automatically. The automatic reversing feature is, however, only an aid and is no substitute for your attention when closing the sliding sunroof.

WARNING

The reversing feature does not react:

- to soft, light and thin objects, e.g. small fingers
- over the last 4 mm of the closing movement
- during resetting
- when closing the sliding sunroof again manually immediately after automatic reversing

This means that the reversing feature cannot prevent someone being trapped in these situations. There is a risk of injury.

When closing make sure that no body parts are in the closing area.

If someone is trapped:

- release the switch immediately or
- press the switch in any direction during the automatic closing process

The closing process is stopped.

Operating the panorama sliding sunroof

Opening and closing

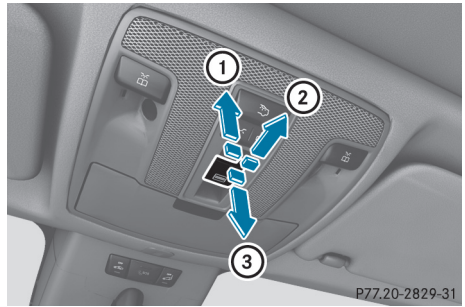

- ① To raise
- ② To open
- ③ To close/lower

The panorama sliding sunroof can be operated only when the roller sunblind is open.

- ▶ Turn the key to position **1** or **2** in the ignition lock (▷ page 135).
- ▶ Press or pull the  switch in the corresponding direction.

If you press/pull the  switch beyond the pressure point, automatic operation is started in the corresponding direction. You can stop automatic operation by pressing/pulling again.

After the sliding sunroof is opened, the roller sunblind automatically closes slightly. This reduces draughts in the vehicle interior.

If the sliding sunroof is raised at the rear, it automatically lowers slightly at higher speeds. The noise level in the vehicle interior is reduced as a result.

At low speeds, it rises again automatically.

You can also temporarily deactivate automatic lowering. To do so, press the  switch. The sliding sunroof raises again automatically.

You can continue to operate the sliding sunroof after switching off the engine or removing the key. This function remains active for five minutes or until you open a front door.

The sliding sunroof cannot be opened if a roof carrier is fitted. In order to allow ventilation of the vehicle interior, you can raise the sliding sunroof.

If contact is made with a roof carrier approved by Mercedes-Benz, the sliding sunroof lowers slightly but remains raised at the rear.

Rain-closing feature when the engine is switched off

The rain-closing feature is only available for vehicles with a rain sensor.

When the key is in position  in the ignition lock or is removed, the panorama sliding sunroof closes automatically:

- if it starts to rain
- at extreme outside temperatures
- after six hours
- if there is a malfunction in the power supply

The panorama sliding sunroof remains raised at the rear in order to allow ventilation of the vehicle interior.

If the panorama sliding sunroof is obstructed when being closed by the rain-closing feature, it opens again slightly. The rain-closing feature is then deactivated.

The panorama sliding sunroof does not close if:



- it is raised at the rear
- it is blocked
- no rain is falling on the area of the windscreen being monitored by the rain sensor. If the vehicle, for example, is under a bridge or in a carport, the field of the sensor may be covered.

Rain-closing feature when driving

The raised panorama sliding sunroof automatically lowers when you are driving if it starts to rain. The sliding sunroof is lowered depending on:

- the road speed and
- the intensity of the rain

You can manually cancel the automatic closing procedure. Push or pull the  switch in any direction.

To raise the panorama sliding sunroof again, push the  switch in direction . The rain-closing feature remains activated.

Operating the roller sunblind for the panorama sliding sunroof

Important safety notes

WARNING

Parts of the body could become trapped between the roller sunblind and frame or sliding sunroof during automatic opening or closing. There is a risk of injury.

When opening or closing, make sure that no body parts are in the sweep of the roller sunblind.

If someone is trapped:

- release the switch immediately or
- press the switch in any direction during the automatic opening/closing process

The opening/closing process is stopped.

The roller sunblind shields the vehicle interior from sunlight. The roller sunblind can be opened and closed only when the panorama sliding sunroof is closed.

Roller sunblind reversing feature

The roller sunblind is equipped with an automatic reversing feature. If an object blocks or restricts the roller sunblind during the closing process, the roller sunblind opens again automatically. The automatic reversing feature is, however, only an aid and is no substitute for your attention when closing the roller sunblind.

WARNING

The reversing feature does not react:

- to soft, light and thin objects, e.g. small fingers
- when closing the roller sunblind again manually immediately after automatic reversing

This means that the reversing feature cannot prevent someone being trapped in these situations. There is a risk of injury.

When closing the roller sunblind, make sure that no body parts are in the sweep.

If someone is trapped:

- release the switch immediately or
- press the switch in any direction during the automatic closing process

The closing process is stopped.

Opening and closing

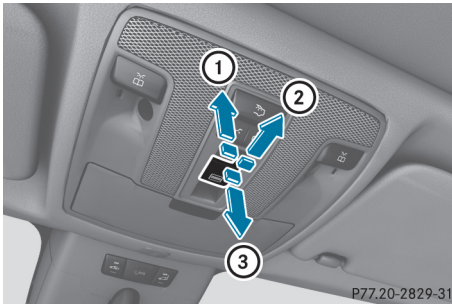

- ① To open
- ② To open
- ③ To close

- ▶ Turn the key to position ① or ② in the ignition lock (▶ page 135).
- ▶ Press or pull the  switch in the corresponding direction.



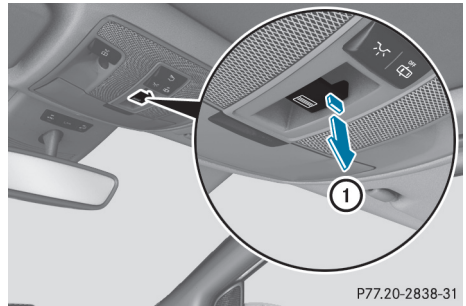

If you press/pull the  switch beyond the point of resistance, automatic operation is started in the corresponding direction. You can stop automatic operation by pressing/pulling again.

After the panorama sliding sunroof is opened, the roller sunblind automatically closes slightly. This reduces draughts in the vehicle interior.

Resetting the panorama sliding sunroof or the roller sunblind



Reset the panorama sliding sunroof or the roller sunblind if the panorama sliding sunroof or the roller sunblind does not move smoothly.



- ▶ Turn the key to position ① or ② in the ignition lock (▶ page 135).
- ▶ Pull the  switch repeatedly to the point of resistance in the direction of arrow ① until the panorama sliding sunroof is fully closed.
- ▶ Keep the  switch pulled for an additional second.
- ▶ Pull the  switch repeatedly to the point of resistance in the direction of arrow ① until the roller sunblind is fully closed.
- ▶ Keep the  switch pulled for an additional second.
- ▶ Make sure that the panorama sliding sunroof and the roller sunblind can be fully opened and closed again.
- ▶ If this is not the case, repeat the steps above.

Problems with the panorama sliding sunroof

WARNING

If you do not reset the sliding sunroof after a malfunction or voltage supply interruption, then the reversing function will malfunction or not work. The sliding sunroof closes with increased or maximum force. Parts of the body could be trapped in the closing area in the process. This poses an increased risk of injury or even fatal injury.

In such or similar situations always make sure that no parts of the body are in the closing area. Always reset the sliding sunroof after a malfunction or voltage supply interruption.

Problem	Possible causes/consequences and ► Solutions
<p>The panorama sliding sunroof cannot be closed and you cannot see the cause.</p>	<p>If the panorama sliding sunroof is obstructed during closing and reopens again slightly:</p> <ul style="list-style-type: none"> ► Immediately after it blocks, pull the  switch down again to the point of resistance until the panorama sliding sunroof is closed. The panorama sliding sunroof is closed with increased force. <p>If the panorama sliding sunroof is obstructed again during closing and reopens again slightly:</p> <ul style="list-style-type: none"> ► Immediately after it blocks, pull the  switch down again to the point of resistance until the panorama sliding sunroof is closed. The panorama sliding sunroof is closed without the automatic reversing function.
<p>The panorama sliding sunroof cannot be opened or closed using the convenience opening/closing feature.</p>	<p>The key battery is weak or discharged.</p> <ul style="list-style-type: none"> ► Check the key battery (▷ page 79) and replace if necessary (▷ page 79).

Correct driver's seat position

WARNING

You could lose control of the vehicle while driving if you:

- adjust the driver's seat, steering wheel or mirrors
- fasten the seat belt

There is a risk of an accident.

Adjust the driver's seat, head restraint, steering wheel and mirrors and fasten your seat belt before starting the engine.



Observe the following when adjusting steering wheel ①, seat belt ② and driver's seat ③:

- you are as far away from the driver's airbag as possible
- you are sitting in an upright position
- your thighs are slightly supported by the seat cushion
- your legs are not fully extended and you can depress the pedals properly
- the back of your head is supported at eye level by the centre of the head restraint
- you can hold the steering wheel with your arms slightly bent
- you can move your legs freely
- you can see all the displays on the instrument cluster clearly

- you have a good overview of traffic conditions
- the seat belt is pulled snugly against the body and must be routed across the centre of your shoulder and across your hips in the pelvic area

Further related subjects:

- Adjusting the seats manually (▷ page 98)
- Adjusting the seats electrically (▷ page 99)
- Adjusting the steering wheel mechanically (▷ page 103)
- Fastening the seat belt correctly (▷ page 44)
- Adjusting the rear-view mirror and exterior mirrors (▷ page 103)
- **Vehicles with a memory function:** saving the seat, steering wheel and exterior mirror settings using the memory function (▷ page 106)

Seats

Important safety notes

WARNING

If children adjust the seats, they could become trapped, especially if they are unattended. There is a risk of injury.

When leaving the vehicle, always take the key with you and lock the vehicle. Never leave children unattended in the vehicle.

The seats can be adjusted when there is no key in the ignition lock.

WARNING

When adjusting a seat, you or another vehicle occupant could become trapped by the guide rail of the seat, for instance. There is a risk of injury.

Make sure that no one has any part of their body within the sweep of the seat when adjusting it.

WARNING

If the driver's seat is not engaged, it could move forwards as far as the next catch during

movement such as braking or abrupt changes of direction. As a result, you would be pushed against your seat belt by the unsecured driver's seat.

This could cause you to lose control of the vehicle. The seat belt cannot protect as intended and could result in additional injury.

There is a risk of an accident and injury.

Before every journey, make sure that the driver's seat is fully engaged.

Observe the safety notes on "Airbags" (▷ page 45) and "Children in the vehicle" (▷ page 55).

WARNING

If the driver's seat is not correctly engaged, it could unexpectedly move while driving. This could cause you to lose control of the vehicle. There is a risk of an accident.

Always ensure that the driver's seat is engaged before starting the vehicle.

WARNING

You could lose control of the vehicle while driving if you:

- adjust the driver's seat, steering wheel or mirrors
- fasten the seat belt

There is a risk of an accident.

Adjust the driver's seat, head restraint, steering wheel and mirrors and fasten your seat belt before starting the engine.

WARNING

If you adjust the seat height carelessly, you or other vehicle occupants could be trapped and thereby injured. Children in particular could accidentally press the electrical seat adjustment buttons and become trapped. There is a risk of injury.

While moving the seats, make sure that your hands or other body parts do not get under the lever assembly of the seat adjustment system.

 To prevent damage to the seats and the seat heating, observe the following notes:

- Do not spill liquids onto the seats. Dry the seats as soon as possible if liquid does get spilled on the seats.
- If the seat covers are damp or wet, do not switch on the seat heating. Also, do not use the seat heating to dry the seats.
- Clean the seat covers as recommended; see the "Interior care" section.
- Do not transport heavy loads on the seats. Do not place pointed objects on the seat cushions such as knives, nails or tools. Where possible, use the seats only for carrying passengers.
- When operating the seat heating, do not cover the seats with insulating materials, e.g. blankets, coats, bags, protective covers, child seats or booster seats.
- When the seat heating is switched on, the seat surface can be damaged as a result of objects being placed on the seats; for example, seat cushions, child seats and protective covers not approved by Mercedes-Benz.

 Make sure that there are no objects in the footwell under or behind the seats when moving the seats back. There is a risk that the seats and/or the objects could be damaged.

 Further related subjects:

- Luggage compartment enlargement (folding down the rear seats) (▷ page 274)

Adjusting the seats manually

Vehicles without the seating comfort package



Seat fore-and-aft adjustment:

- ▶ Lift handle ① and slide the seat forwards or backwards.
- ▶ Release lever ① again.
Ensure that the seat engages audibly.

Backrest angle:

- ▶ Relieve the pressure on the backrest.
- ▶ Turn handwheel ③ forwards or backwards.

Seat height:

- ▶ Pull handle ② upwards or push it down repeatedly until the seat has reached the desired height.

Vehicles with the seating comfort package



Seat fore-and-aft adjustment:

- ▶ Lift handle ① and slide the seat forwards or rearwards.
- ▶ Release lever ① again.
Ensure that the seat engages audibly.

Backrest angle:

- ▶ Relieve the pressure on the backrest.
- ▶ Turn handwheel ⑤ forwards or backwards.

Seat height:

- ▶ Pull handle ④ upwards or push it down repeatedly until the seat has reached the desired height.

Seat cushion angle:

- ▶ Adjust the angle so that your thighs have gentle support.
- ▶ Turn handwheel ③ forwards or backwards.

Seat cushion length:

- ▶ Lift handle ② and slide the front part of the seat cushion forwards or backwards.
- ▶ Release lever ② again.
The seat cushion engages.

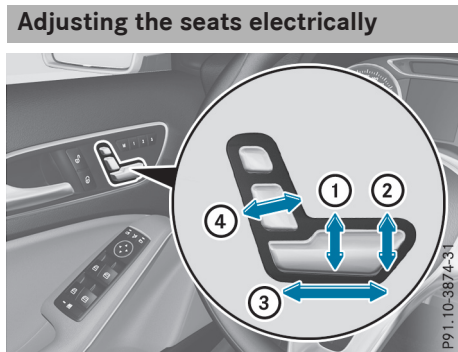

- ① Seat height
- ② Seat cushion angle
- ③ Seat fore-and-aft adjustment
- ④ Backrest angle

i You can store the seat settings using the memory function (▶ page 106).

Adjusting the head restraints

Important safety notes

⚠ WARNING
You could lose control of the vehicle while driving if you:

- adjust the driver's seat, steering wheel or mirrors
- fasten the seat belt

There is a risk of an accident.
Adjust the driver's seat, head restraint, steering wheel and mirrors and fasten your seat belt before starting the engine.

⚠ WARNING
The head restraints cannot provide the intended protection unless they are fitted and adjusted correctly. There is an increased risk

Seats, steering wheel and mirrors

of injury to the head and neck in the event of an accident or sudden braking, for example. Always drive with the head restraints fitted. Ensure that the centre of the head restraints support the back of each vehicle occupant's head at eye level before driving off.

Adjust the head restraint fore-and-aft position so that it is as close as possible to the back of your head.

General notes

For vehicles with sports seats you cannot adjust the front head restraints or the outer rear head restraints.

Adjusting the head restraints manually

Adjusting the head restraint height

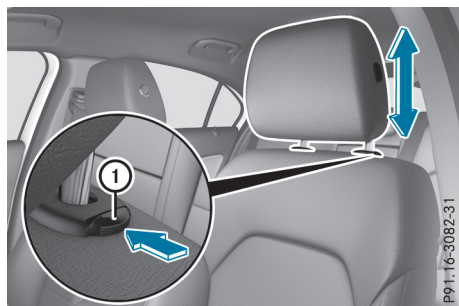

- ▶ **To raise:** pull the head restraint up to the desired position.
- ▶ **To lower:** press release catch ① in the direction of the arrow and push the head restraint down to the desired position.

Adjusting the head restraint fore-and-aft position

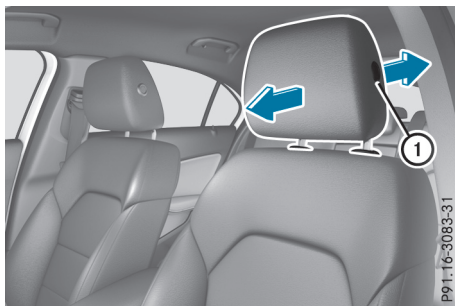

This function allows you to adjust the distance between the head restraint and the back of the head.

- ▶ **To move forwards:** pull the head restraint forwards in the direction of the arrow until it engages. There are a number of detents.
- ▶ **To move backwards:** press and hold release button ① and push the head restraint backwards.
- ▶ When the head restraint is in the desired position, release the button and make sure that the head restraint is engaged in position.

Rear seat head restraints

Adjusting the rear-seat head restraint height

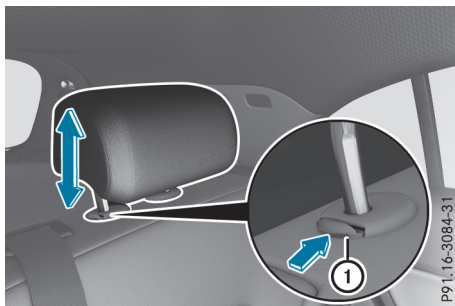

- ▶ **To raise:** pull the head restraint up to the desired height.
- ▶ **To lower:** press release catch ① and push the head restraint down until it is in the desired position.

Removing and fitting the rear seat head restraints

The rear head restraints on the outer seats can be removed and refitted. For vehicles with sports seats the rear head restraints cannot be removed and refitted.

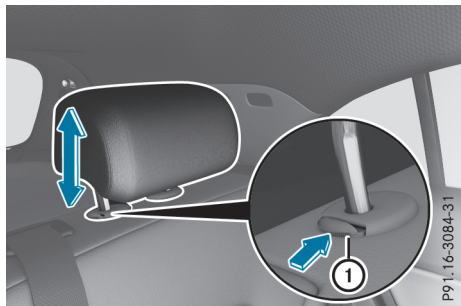

- ▶ Fold the seat backrest slightly forwards in order to remove the head restraint (> page 274).
- ▶ **To remove:** pull the head restraint up to the stop.
- ▶ Press release button ① and pull the head restraint out of the guides.
- ▶ **To refit:** insert the head restraint so that the notches on the bar are on the left when viewed in the direction of travel.
- ▶ Push the head restraint down until you hear it engage in position.

Adjusting the 4-way lumbar support

You can adjust the contour of the front seat backrests individually to provide optimum support for your back.

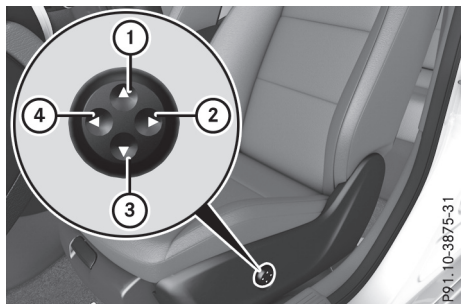

- ① Raises the backrest contour
- ② Softens the backrest contour

- ③ Lowers the backrest contour
- ④ Hardens the backrest contour

AMG Performance Seat

Vehicles with electrically adjustable seats: to adjust the contour of the seat and for improved lateral support, you can individually adjust the front seats.

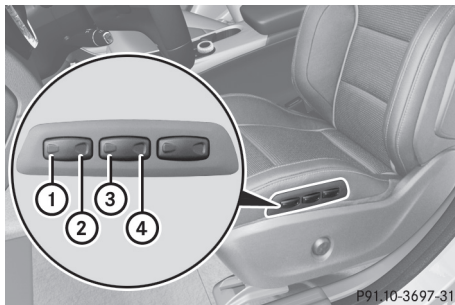

Adjusting the side bolsters of the seat cushion

- ▶ **To set the side bolsters of the seat cushion narrower:** press button ①.
- ▶ **To set the side bolsters of the seat cushion wider:** press button ②.

Adjusting the side bolsters of the seat backrest

- ▶ **To set the side bolsters of the seat backrest narrower:** press button ③.
- ▶ **To set the side bolsters of the seat backrest wider:** press button ④.

Switching the seat heating on/off

Switching on/off

WARNING

If you repeatedly switch on seat heating, the seat cushion and backrest padding may become very hot. The health of vehicle occupants with limited temperature sensitivity or a limited ability to react to high temperatures may be affected or they may even suffer burn-like injuries. There is a risk of injury.

Therefore, do not switch on the seat heating repeatedly.

! When the seat heating is switched on, the seat surface can be damaged as a result of objects being placed on the seats; for example, seat cushions, child seats and protective covers not approved by Mercedes-Benz.

Ensure that there are no objects on the seat surface when the seat heating is switched on.



The three red indicator lamps in the button indicate the heating level you have selected.

The system automatically switches down from level **3** to level **2** after approximately eight minutes.

The system automatically switches down from level **2** to level **1** after approximately ten minutes.

The system automatically switches off approximately 20 minutes after it is set to level **1**.

- ▶ Turn the key to position **1** or **2** in the ignition lock (▷ page 135).
- ▶ **To switch on:** press button **1** repeatedly until the desired heating level is set.
- ▶ **To switch off:** press button **1** repeatedly until all the indicator lamps go out.

i If the vehicle battery voltage is too low, the seat heating may switch off.

Problems with the seat heating

Problem	Possible causes/consequences and ▶ Solutions
The seat heating has switched off prematurely or cannot be switched on.	<p>The on-board voltage is too low because too many electrical consumers are switched on.</p> <ul style="list-style-type: none"> ▶ Switch off electrical consumers that you do not need, such as the rear window heating or interior lighting. <p>Once the battery is sufficiently charged, the seat heating will switch back on automatically.</p>

Steering wheel

Important safety notes

! WARNING

You could lose control of the vehicle while driving if you:

- adjust the driver's seat, steering wheel or mirrors
- fasten the seat belt

There is a risk of an accident.

Adjust the driver's seat, head restraint, steering wheel and mirrors and fasten your seat belt before starting the engine.

! WARNING

Children could injure themselves if they adjust the steering wheel. There is a risk of injury.

When leaving the vehicle, always take the key with you and lock the vehicle. This also applies to mobile phones if the "Digital Car Key in smartphone" function is activated via the Mercedes me connect web app. Never leave children unattended in the vehicle.

Adjusting the steering wheel

⚠ WARNING

The steering wheel may move unexpectedly if you adjust it while driving. This could cause you to lose control of the vehicle. There is a risk of an accident.

Make sure that the steering wheel is locked before driving off. Never unlock the steering wheel when the vehicle is in motion.

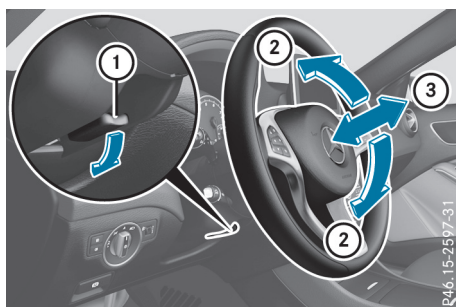

- ① Release lever
 - ② To adjust the steering wheel height
 - ③ To adjust the steering wheel position (fore-and-aft adjustment)
- ▶ Push release lever ① down completely. The steering column is unlocked.
 - ▶ Adjust the steering wheel to the desired position.
 - ▶ Push release lever ① up as far as it will go. The steering column is locked.
 - ▶ Check that the steering column is locked. When doing so, try to push the steering wheel up or down or try to move it in the fore-and-aft direction.

Mirrors

Rear-view mirror



- ▶ **Anti-dazzle mode:** pivot anti-dazzle switch ① forwards or back.

Exterior mirrors

Adjusting the exterior mirrors

⚠ WARNING

You could lose control of the vehicle while driving if you:

- adjust the driver's seat, steering wheel or mirrors
- fasten the seat belt

There is a risk of an accident.

Adjust the driver's seat, head restraint, steering wheel and mirrors and fasten your seat belt before starting the engine.

⚠ WARNING

The exterior mirrors reduce the size of the image. Objects visible in the mirrors are closer than they appear. You could misjudge the distance from road users driving behind you when changing lanes, for instance. There is a risk of an accident.

You should therefore always look over your shoulder to determine the actual distance from road users driving behind you.

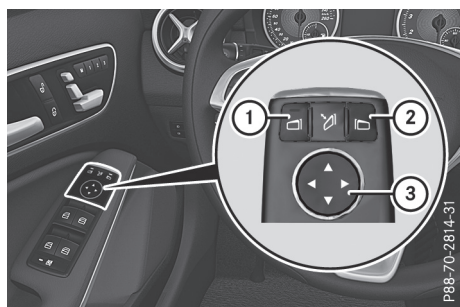

- ▶ Turn the key to position **1** or **2** in the ignition lock (▷ page 135).
- ▶ Exterior mirror on the front-passenger side: press button **2**.
Exterior mirror on the driver's side: press button **1**.
The indicator lamp in the corresponding button lights up in red.
The indicator lamp goes out again after some time. You can adjust the selected exterior mirror using button **3** as long as the indicator lamp is lit.
- ▶ Press button **3** up, down, or to the right or left until you have adjusted the exterior mirror to the correct position. You should have a good overview of traffic conditions.

The convex exterior mirrors provide a larger field of vision.

After the engine has been started, the exterior mirrors are automatically heated at low outside temperatures. Heating takes a maximum of ten minutes.

- i** The exterior mirrors can also be heated manually by switching on the rear window heating.

Folding the exterior mirrors in/out electrically

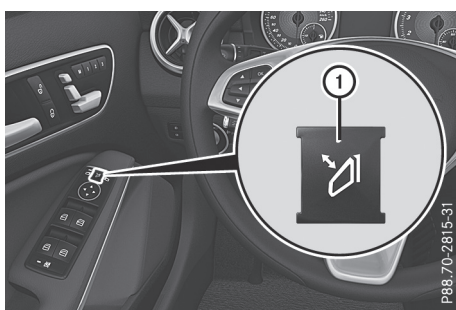

- ▶ Turn the key to position **1** or **2** in the ignition lock (▷ page 135).
- ▶ Briefly press button **1**.
Both exterior mirrors fold in or out.
- i** Make sure that the exterior mirrors are always folded out fully while driving. Otherwise, they could vibrate.
- i** If you are driving faster than 47 km/h, you can no longer fold in the exterior mirrors.

Resetting the exterior mirrors

If the battery has been disconnected or completely discharged, the exterior mirrors must be reset. The exterior mirrors will otherwise not fold in when you select the "Fold in mirrors when locking" function in the on-board computer (▷ page 215).

- ▶ Turn the key to position **1** in the ignition lock (▷ page 135).
- ▶ Briefly press button **1**.

Folding the exterior mirrors in/out automatically

If the "Fold in mirrors when locking" function is activated in the on-board computer (▷ page 215):

- the exterior mirrors fold in automatically as soon as you lock the vehicle from the outside
- the exterior mirrors fold out again automatically as soon as you unlock the vehicle and then open the driver's or front-passenger door

- i** If the exterior mirrors have been folded in manually, they do not fold out.

Exterior mirror pushed out of position

If an exterior mirror has been pushed out of position (forwards or backwards), proceed as follows:

Automatic anti-dazzle mirrors

WARNING

Electrolyte may escape if the glass in an automatic anti-dazzle mirror breaks. The electrolyte is harmful and causes irritation. It must not come into contact with your skin, eyes, respiratory organs or clothing or be swallowed. There is a risk of injury.

If you come into contact with the electrolyte, observe the following:

- Rinse off the electrolyte from your skin immediately with water.
- Immediately rinse the electrolyte out of your eyes thoroughly with clean water.
- If the electrolyte is swallowed, immediately rinse your mouth out thoroughly. Do not induce vomiting.
- If electrolyte comes into contact with your skin or hair or is swallowed, seek medical attention immediately.
- Immediately change out of clothing which has come into contact with electrolyte.
- If an allergic reaction occurs, seek medical attention immediately.

The "Automatic anti-dazzle mirrors" function is only available if the vehicle is equipped with the "Mirror package".

The rear-view mirror and the exterior mirror on the driver's side automatically go into anti-dazzle mode if:

- the ignition is switched on and
- incident light from headlamps strikes the sensor in the rear-view mirror

The mirrors do not go into anti-dazzle mode if reverse gear is engaged or if the interior lighting is switched on.

Parking position of the exterior mirror on the front-passenger side

Setting and storing the parking position

You can adjust the front-passenger side exterior mirror such that you can see the rear wheel on that side as soon as you engage reverse gear. You can store this position.

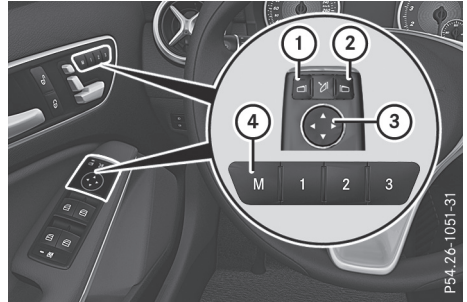

- ① Button for the exterior mirror on the driver's side
- ② Button for the exterior mirror on the front-passenger side
- ③ Button for the exterior mirror setting
- ④ Memory button **M**

- ▶ Make sure that the vehicle is stationary.
- ▶ Turn the key to position **2** in the ignition lock or start the engine (▷ page 135).
- ▶ Press button **②**.
- ▶ Engage reverse gear.
 - The exterior mirror on the front-passenger side moves to the default parking position.
- ▶ Use button **③** to adjust the exterior mirror to a position that allows you to see the rear wheel and the kerb.
 - The parking position is stored.

i If you shift the transmission to another position, the front-passenger side exterior mirror returns to the driving position.

Calling up a stored parking position

- ▶ Turn the key to position **2** in the ignition lock (▷ page 135).
- ▶ Adjust the front-passenger side exterior mirror using the corresponding button (▷ page 103).
- ▶ Engage reverse gear.
 - The exterior mirror on the front-passenger side moves to the stored parking position.

The exterior mirror on the front-passenger side moves back to its original position:

- as soon as you exceed a speed of 15 km/h
- about ten seconds after you have disengaged reverse gear
- when you use button ① to select the exterior mirror on the driver's side

Memory function

Important safety notes

⚠ WARNING

If you use the memory function on the driver's side while driving, the adjustments could cause you to lose control of the vehicle. There is a risk of an accident.

Only use the memory function on the driver's side while the vehicle is stationary.

⚠ WARNING

If the memory function adjusts the seat, you and other vehicle occupants – particularly children – could become trapped. There is a risk of injury.

While the memory function is making adjustments, make sure that no one has any part of their body within the sweep of the seat. If someone becomes trapped, immediately release the memory function position button. The adjustment is stopped.

⚠ WARNING

Children could become trapped if they activate the memory function, particularly when unattended. There is a risk of injury.

When leaving the vehicle, always take the key with you and lock the vehicle. This also applies to mobile phones if the "Digital Car Key in smartphone" function is activated via the Mercedes me connect web app. Never leave children unattended in the vehicle.

The memory function can be used at any time, e.g. even when the key is not in the ignition lock.

Storing settings

Using the memory function, you can store up to three different settings, e.g. for three different people.

The following settings are stored as a single memory preset:

- seat and backrest position
- driver's side: position of the exterior mirrors on the driver's and front-passenger sides



- ▶ Adjust the seat (▷ page 99).
 - ▶ Adjust the exterior mirror on the driver's side (▷ page 103).
 - ▶ Briefly press the **M** memory button and then press preset position button **1**, **2** or **3** within three seconds.
- The settings are stored in the selected memory position. A tone sounds when the settings have been completed.

Calling up a stored setting

- ▶ Press and hold the relevant preset position button **1**, **2** or **3** until the seat and exterior mirrors are in the stored position.
- ⓘ The setting procedure is interrupted as soon as you release the storage position button.

Exterior lighting

General notes

For reasons of safety, Mercedes-Benz recommends that you drive with lights switched on even during the daytime. In some countries, operation of the headlamps varies due to legal requirements and voluntary recommendations.

Driving abroad

Vehicles with halogen or LED headlamps

It is not necessary to switch your headlamps to symmetrical dipped beam when driving in countries where vehicles are driven on the opposite side of the road to the country in which the vehicle is registered. Legal requirements are fulfilled without switching the headlamps to symmetrical dipped beam.

Symmetrical dipped beam

It is not necessary to switch your headlamps to symmetrical dipped beam when driving in countries where vehicles are driven on the opposite side of the road to the country in which the vehicle is registered. Legal requirements are fulfilled without switching the headlamps to symmetrical dipped beam.

Setting the exterior lighting

Setting options

Exterior lighting can be set using the:

- light switch
- combination switch (▷ page 109)
- headlamp range adjustment (only vehicles with halogen headlamps) (▷ page 109)
- on-board computer (▷ page 213)

Light switch

Operation

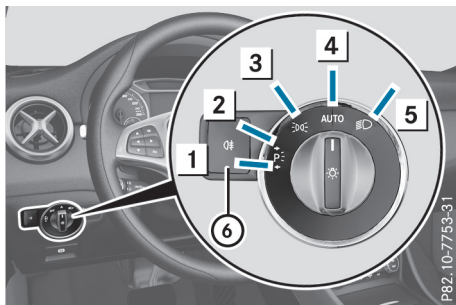

- | | | |
|---|------|---|
| 1 | ←P≡ | Left-hand parking lamps |
| 2 | P≡→ | Right-hand parking lamps |
| 3 | >00< | Side lamps, licence plate and instrument cluster lighting |
| 4 | AUTO | Automatic headlamp mode, controlled by the light sensor |
| 5 | ☾ | Dipped-beam/main-beam headlamps |
| 6 | 0# | Rear foglamp |

If you hear a warning tone when you leave the vehicle, the lights may still be switched on.

► Turn the light switch to the **AUTO** position.

The exterior lighting (except the side lamps or parking lamps) switches off automatically if you:

- remove the key from the ignition lock
- open the driver's door with the key in position **0** in the ignition lock

Automatic headlamp mode

AUTO is the preferred light switch position:

- the light setting is automatically selected according to the brightness of the ambient light (exception: poor visibility due to weather conditions such as fog, snow or spray)
- key in position **1** in the ignition lock: the side lamps are switched on or off automatically depending on the brightness of the ambient light
- with the engine running: if you have switched on the **Daytime driving lights** function via the on-board computer, the daytime driving lights or the side lamps and dipped-beam headlamps are switched on or off automati-

cally depending on the brightness of the ambient light

- with the engine running: if you have switched on the **Daytime driving lights** function via the on-board computer, the daytime driving lights or the side lamps and dipped-beam headlamps are switched on or off automatically depending on the brightness of the ambient light

- ▶ **To switch on automatic headlamp mode:** turn the light switch to the **AUTO** position.

WARNING



When the light switch is set to **AUTO**, the dipped-beam headlamps may not be switched on automatically if there is fog, snow or other causes of poor visibility due to the weather conditions such as spray. There is a risk of an accident.

In such situations, turn the light switch to





The automatic headlamp feature is only an aid. The driver is responsible for the vehicle lighting at all times.

The daytime driving lights improve the visibility of your vehicle during the day. Here, the daytime driving lights function must be switched on via the on-board computer (▷ page 213).

If the side lamps and dipped-beam headlamps are switched on, the green indicator lamps  (side lamps) and  (dipped-beam headlamps) in the instrument cluster light up.





Dipped-beam headlamps

When the ignition is switched on and the light switch is in the  position, the side lamps and dipped-beam headlamps are switched on even if the light sensor does not sense dark ambient light conditions. This is advantageous when there is fog or rain.



- ▶ **To switch on the dipped-beam headlamps:** turn the key to position **2** in the ignition lock or start the engine.
- ▶ Turn the light switch to . The green  indicator lamp on the instrument cluster lights up.



Rear foglamp

The rear foglamp improves the visibility of your vehicle for the traffic behind in the event of heavy fog. Please observe the country-specific laws on the use of rear fog lamps.

- ▶ **To switch on the rear fog lamp:** turn the key in the ignition lock to position **2** or start the engine.
- ▶ Turn the light switch to  or **AUTO**.
- ▶ Press the  button. The yellow  indicator lamp in the instrument cluster lights up.
- ▶ **To switch off the rear foglamp:** press the  button. The yellow  indicator lamp in the instrument cluster goes out.



Side lamps

- ⚠ When the battery is discharged heavily, the side lamps or parking lamps are automatically switched off to facilitate an engine start. Always park your vehicle safely and in a well lit area, in accordance with the relevant legal stipulations. Avoid using the  side lamps for periods lasting several hours. Where possible, switch on the right  or left  parking lamp.

- ▶ **To switch on:** turn the light switch to . The green  indicator lamp in the instrument cluster lights up.

Parking lamps

Switching on the parking lamps ensures that the corresponding side of the vehicle is illuminated.

- ▶ **To switch on the parking lamps:** the key should not be in the ignition lock or it should be in key position **0** in the ignition lock.
- ▶ Turn the light switch to  (left-hand side of the vehicle) or  (right-hand side of the vehicle).

Adjusting the headlamp range (halogen headlamps)

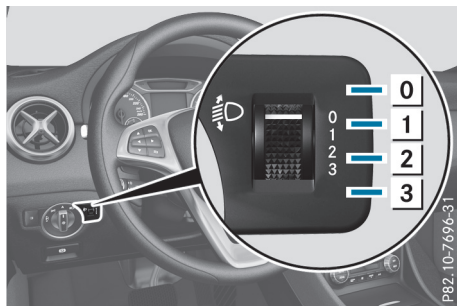

- 0 Driver's seat and front-passenger seat occupied
- 1 Driver's seat, front-passenger seat and rear seats occupied
- 2 Driver's seat, front-passenger seat and rear seats occupied, luggage compartment laden
- 3 Driver's seat and front-passenger seat occupied and maximum permissible rear axle load utilised, e.g. when towing a trailer

The headlamp range control allows you to adjust the cone of light from the headlamps to suit the vehicle load.

- ▶ Start the engine.
- ▶ Turn the headlamp range controller to the position that corresponds to the load in your vehicle.

Combination switch

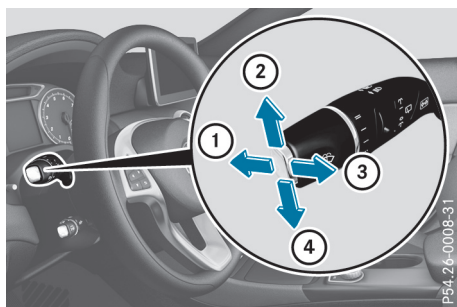

- ▶ **To indicate briefly:** press the combination switch briefly to the pressure point in the direction of arrow ② or ④. The corresponding turn signal flashes three times.
- ▶ **To indicate:** press the combination switch beyond the pressure point in the direction of arrow ② or ④.
- ▶ **To switch on the main-beam headlamps:** turn the light switch to or **AUTO**.
- ▶ Press the combination switch beyond the pressure point in the direction of arrow ①. The main-beam headlamps only switch on in the **AUTO** position if the dipped-beam headlamps are on. The blue indicator lamp in the instrument cluster lights up when the main-beam headlamps are switched on.
- ▶ **To switch off the main-beam headlamps:** move the combination switch back to its normal position. The blue indicator lamp in the instrument cluster goes out. Vehicles with Adaptive Highbeam Assist: when Adaptive Highbeam Assist is active, it controls activation and deactivation of the main-beam headlamps (▷ page 110).
- ▶ **To switch on the headlamp flasher:** pull the combination switch in the direction of arrow ③.

Hazard warning lamps



- ▶ **To switch on the hazard warning lamps:** press button ①. All turn signals flash. If you now switch on a turn signal using the combination switch, only

the turn signal lamp on the corresponding side of the vehicle will flash.

- ▶ **To switch off the hazard warning lamps:** press button ①.

The hazard warning lamps switch on automatically if:

- an airbag is deployed or
- the vehicle decelerates rapidly from a speed of above 70 km/h and comes to a standstill

The hazard warning lamps switch off automatically if the vehicle reaches a speed of above 10 km/h again after a full brake application.

The hazard warning lamps continue to operate even if the ignition is switched off.

Adaptive Highbeam Assist

General notes

You can use this function to set the headlamps to switch automatically between dipped beam and main beam. The system detects vehicles with their lights on, either approaching from the opposite direction or travelling in front of your vehicle, and consequently switches the headlamps from main beam to dipped beam. Once the system no longer detects any other vehicles, it switches on the main-beam headlamps again.

The system's optical sensor is located behind the windscreen near the overhead control panel.

Important safety notes

WARNING

Adaptive Highbeam Assist does not recognise road users:

- who have no lights, e.g. pedestrians
- who have poor lighting, e.g. cyclists
- whose lighting is blocked, e.g. by a barrier

On very rare occasions, Adaptive Highbeam Assist may fail to recognise other road users that have lights, or may recognise them too late. In this, or in similar situations, the automatic main-beam headlamps will not be deactivated or will be activated despite the presence of other road users. There is a risk of an accident.



Always carefully observe the traffic conditions and switch off the main-beam headlamps in good time.

Adaptive Highbeam Assist cannot take into account road, weather or traffic conditions. Adaptive Highbeam Assist is only an aid. You are responsible for adjusting the vehicle's lighting to the prevailing light, visibility and traffic conditions.

In particular, the detection of obstacles can be restricted if there is:

- poor visibility, e.g. due to fog, heavy rain or snow
- dirt on the sensors or if the sensors are obscured



Switching Adaptive Highbeam Assist on/off

- ▶ **To activate:** turn the light switch to .
- ▶ Press the combination switch beyond the pressure point in the direction of arrow ①. When the  light sensor switches on the dipped-beam headlamps when it is dark, the indicator lamp in the multifunction display lights up.

If you are driving at speeds above approximately 30 km/h and no other road users are recognised:

The main-beam headlamps are switched on automatically. The  indicator lamp in the instrument cluster also lights up.

If you are driving at speeds below 25 km/h or other road users are recognised or the roads are adequately lit:

The main-beam headlamps are switched off automatically. The  indicator lamp in the instrument cluster goes out. The  indicator lamp in the multifunction display remains lit.

- ▶ **To deactivate:** move the combination switch back to its normal position. The  indicator lamp in the multifunction display goes out.

Headlamps misted up on the inside

Certain climatic and physical conditions may cause moisture to form in the headlamp. This

moisture does not affect the functionality of the headlamp.

Interior lighting

Overview of interior lighting

Front overhead control panel

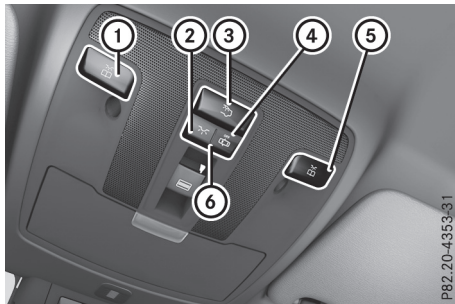

- ① Switches the left-hand front reading lamp on or off
- ② Switches the front interior lighting on
- ③ Switches the rear interior lighting on/off
- ④ Switches the front interior lighting/automatic interior lighting control off
- ⑤ Switches the right-hand front reading lamp on or off
- ⑥ Switches the automatic interior lighting control on

Rear compartment control panel

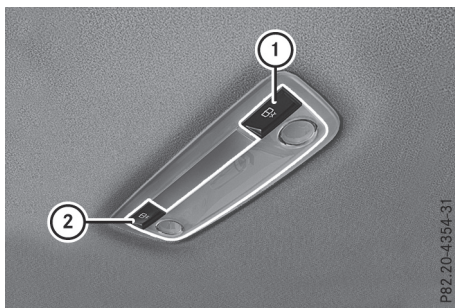

- ① Switches the left-hand reading lamp on/off
- ② Switches the right-hand reading lamp on/off

Interior lighting control

General notes

In order to prevent the vehicle's battery from discharging, the interior lighting functions are automatically deactivated after some time except for when the key is in position **2** in the ignition lock.

The colour and brightness of the ambient lighting are set via the multimedia system (see Digital Owner's Manual).

Automatic interior lighting control

- ▶ **To switch on:** set the switch to centre position **⑥**.
- ▶ **To switch off:** set the switch to the position.

The interior lighting automatically switches on if you:

- unlock the vehicle
- open a door
- remove the key from the ignition lock

The interior lighting is switched on for a certain length of time when the key is removed from the ignition lock. You can set this delayed switch-off via the multimedia system (see Digital Owner's Manual).

Replacing bulbs

Important safety notes

WARNING

Bulbs, lamps and plug connectors can become very hot during use. When replacing a bulb, you could burn yourself on these components. There is a risk of injury.

Allow these components to cool down before replacing the bulb.

Do not use a bulb if it has been dropped or if its glass has been scratched.

The bulb may explode if:

- you touch it
- it is hot
- you drop it
- you scratch it

Use bulbs only in closed lamps that have been designed for this purpose. Fit only spare bulbs of the same type and the specified voltage.

Marks on the glass reduce the service life of the bulbs. Do not touch the glass tube with your bare hands. If necessary, clean the glass tube when cold with alcohol or spirit and rub it off with a lint-free cloth.

Protect bulbs from moisture during operation. Do not allow bulbs to come into contact with liquids.

Replace only the bulbs listed (▷ page 112). Have the bulbs that you cannot replace yourself replaced at a qualified specialist workshop.

If you require assistance replacing bulbs, consult a qualified specialist workshop.

If the new bulb still does not light up, consult a qualified specialist workshop.

Headlamps and lights are an important aspect of vehicle safety. You must therefore make sure that these function correctly at all times. Have the headlamp setting verified regularly.

Vehicles with LED headlamps: the front and rear lamp clusters of your vehicle are equipped with LED bulbs. Do not replace the bulbs yourself. Contact a qualified specialist workshop with the necessary specialist knowledge and tools to carry out the work required.

Overview of bulb types

You can replace the following bulbs. The details for the bulb types can be found in the legend.

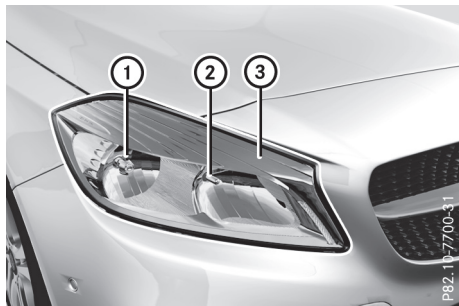

Vehicles with halogen headlamps

- ① Dipped-beam headlamp: H7 55 W
- ② Main-beam headlamp/side lamp/parking lamp: H15 55 W/15 W
- ③ Turn signal lamp: PY 21 W

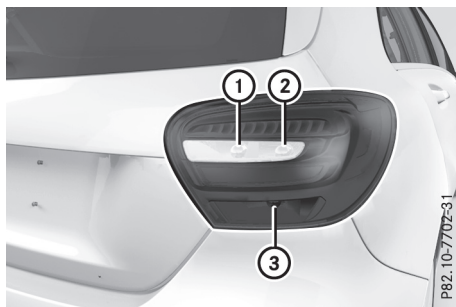

Tail lamps (vehicles with halogen headlamps)

- ① Reversing lamp: P 21 W
- ② Turn signal lamp: PY 21 W
- ③ Rear foglamp: P 21 W

Replacing front bulbs

Fitting/removing the cover on the front wheel arch

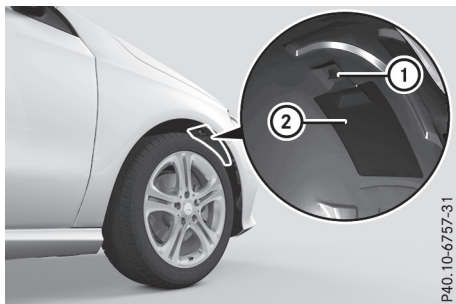

You must remove the cover in the front wheel arch before you can change the front turn signal lamp.

- ▶ **To remove:** switch off the lights.
- ▶ Turn the front wheels inwards.
- ▶ Turn rotary knob ① through 90°. Cover ② is released.
- ▶ Push cover ② down.
- ▶ **To fit:** push cover ② up.
- ▶ Turn rotary knob ① through 90°. Cover ② is locked.

Dipped-beam headlamps (halogen headlamps)

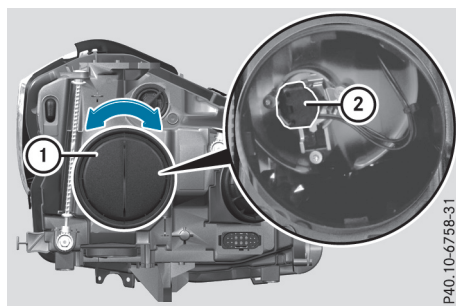

P40.10-6756-31

- ▶ Remove the cover in the front wheel arch (▷ page 112).
- ▶ Turn housing cover ① anti-clockwise and remove it.
- ▶ Turn bulb holder ② anti-clockwise and pull out.
- ▶ Pull the bulb out of bulb holder ②.
- ▶ Insert the new bulb into bulb holder ②.
- ▶ Insert bulb holder ② and turn it clockwise.
- ▶ Press on housing cover ① and turn it to the right.
- ▶ Replace the cover in the front wheel arch (▷ page 112).

Main-beam headlamps and side lamps/parking lamps (vehicles with halogen headlamps)

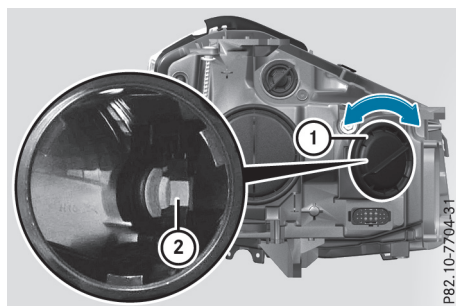

P82.10-7704-31

- ▶ Switch off the lights.
- ▶ Open the bonnet.
- ▶ Turn housing cover ① anti-clockwise and remove it.
- ▶ Turn bulb holder ② anti-clockwise and pull out.

- ▶ Insert the new bulb and engage it to the stop.
- ▶ Press on housing cover ① and turn it to the right.

Turn signal lamp (halogen headlamps)

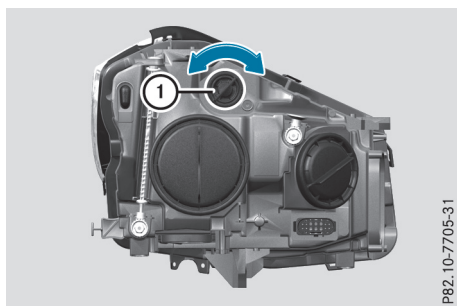

P82.10-7705-31

- ▶ Switch off the lights.
- ▶ Open the bonnet.
- ▶ Turn bulb holder ① anticlockwise and pull out.
- ▶ Turn the bulb anti-clockwise and pull it out of bulb holder ①.
- ▶ Insert the new bulb into bulb holder ①.
- ▶ Insert bulb holder ① and turn it clockwise until it engages.

Replacing rear bulbs

Opening and closing the side trim panels

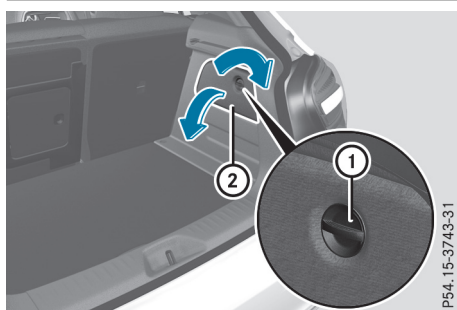

P54.15-3743-31

View of right-hand side trim panel

You must open the side trim panel in the luggage compartment before you can replace the bulbs in the tail lamps.

- ▶ **To open:** turn release knob ① clockwise and remove side trim panel ②.
- ▶ **To close:** insert side trim panel ② and turn release knob ① anti-clockwise.

Tail lamps

- ▶ Switch off the lights.
- ▶ Open the luggage compartment.
- ▶ Open the side trim panel (▷ page 113).

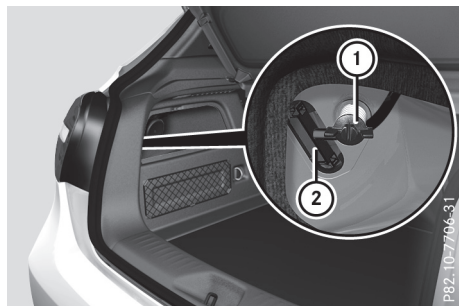

- ▶ Release and remove connector ②.
- ▶ Hold the tail lamp and unscrew wing nut ①.
- ▶ Remove the tail lamp.

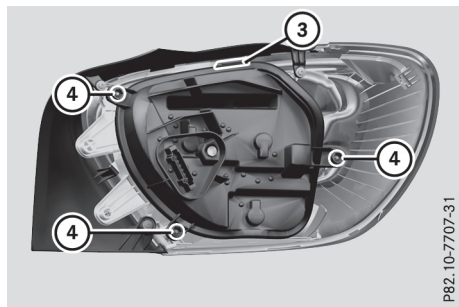

Tail lamps

- ▶ Remove nuts ④ using a suitable item, e.g. a coin.
- ▶ Release attachment ③.
- ▶ Remove the bulb holder from the tail lamp.

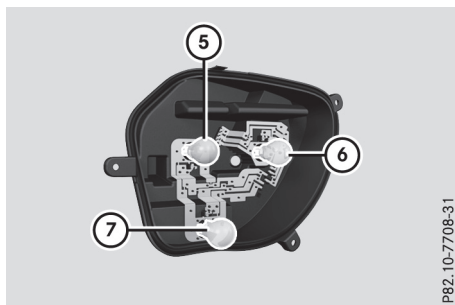

Bulb holder

- ⑤ Reversing light
- ⑥ Turn signal
- ⑦ Rear fog lamp

- ▶ **Reversing lamp and rear foglamp:** press the bulb gently into the bulb holder, turn it anti-clockwise and remove it from the bulb holder.
- ▶ Insert the new bulb into the bulb holder and turn it clockwise.
- ▶ **Turn signal:** press the bulb gently into the bulb holder, turn it anti-clockwise and remove it from the bulb holder.
- ▶ Insert the new bulb into the bulb holder and turn it clockwise.
- ▶ Secure the bulb holder to attachment ③ on the tail lamp and tighten nuts ④.

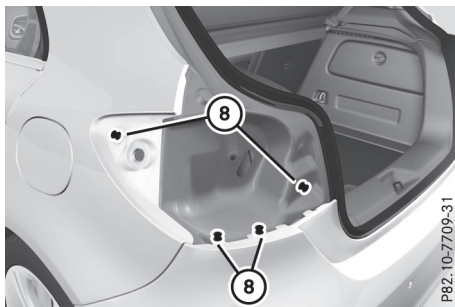

- ▶ Insert the tail lamp into the vehicle and make sure that it sits correctly in guides ⑧.
- ▶ Tighten wing nut ① and re-establish contact with connector ②.
- ▶ Close the side trim panel (▷ page 113).

Windscreen wipers

Switching the windscreen wipers on/off

! Do not operate the windscreen wipers when the windscreen is dry, as this could damage the wiper blades. Moreover, dust that has collected on the windscreen can scratch the glass if wiping takes place when the windscreen is dry.

If it is necessary to switch on the windscreen wipers in dry weather conditions, always operate them using washer fluid.

! If the windscreen wipers leave smears on the windscreen after the vehicle has been washed in an automatic car wash, this may be due to wax or other residue. Clean the windscreen with washer fluid after an automatic car wash.

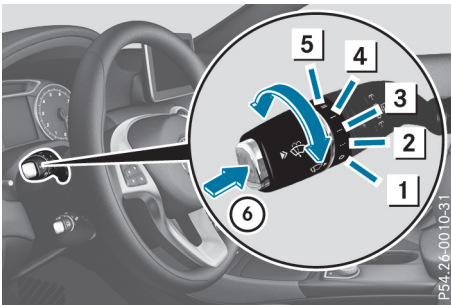

Combination switch

- 1 Windscreen wipers off
- 2 Intermittent wipe, low (rain sensor set to low sensitivity)
- 3 Intermittent wipe, high (rain sensor set to high sensitivity)
- 4 Continuous wipe, slow
- 5 Continuous wipe, fast
- 6 Single wipe/ wipes the windscreen using washer fluid

- ▶ Turn the key to position **1** or **2** in the ignition lock (▷ page 135).
- ▶ Turn the combination switch to the corresponding position.

! Vehicles with a rain sensor: if the windscreen becomes dirty in dry weather conditions, the windscreen wipers may be activated inadvertently. This could damage the

windscreen wiper blades or scratch the windscreen.

For this reason, you should always switch off the windscreen wipers in dry weather.

Vehicles with a rain sensor: in the or position, the appropriate wiping frequency is automatically set according to the intensity of the rain. In the position, the rain sensor is more sensitive than in the position, causing the windscreen wiper to wipe more frequently.

If the wiper blades are worn, the windscreen will no longer be wiped properly. This could mean you are unable to observe the traffic conditions.

Switching the rear window wiper on/off

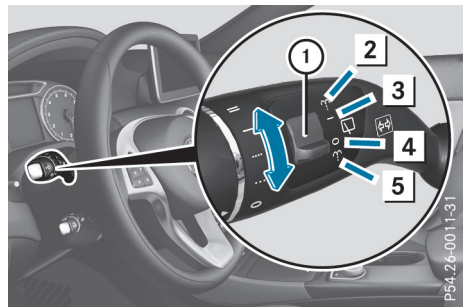

Combination switch

- ① Switch
- 2 Wipes with washer fluid
- 3 Switches on intermittent wiping
- 4 Switches off intermittent wiping
- 5 Wipes with washer fluid

- ▶ Turn the key to position **1** or **2** in the ignition lock (▷ page 135).
- ▶ Slide switch ① on the combination switch to the corresponding position. When the rear window wiper is switched on, the symbol appears in the assistance graphic in the instrument cluster. Further information on the assistance graphic (▷ page 210).

Replacing the wiper blades

Important safety notes

WARNING

If the windscreen wipers begin to move while you are changing the wiper blades, you can be trapped by the wiper arm. There is a risk of injury.

Always switch off the windscreen wipers and ignition before changing the wiper blades.

! To avoid damaging the windscreen wiper blades, make sure that you touch only the wiper arm of the windscreen wiper.

! Never open the bonnet/tailgate if a wiper arm is folded away from the windscreen/rear window.

Never fold a windscreen wiper arm without a wiper blade back onto the windscreen/rear window.

Hold the windscreen wiper arm firmly when you change the wiper blade. If you release the wiper arm without a wiper blade and it falls onto the windscreen/rear window, the windscreen/rear window may be damaged by the force of the impact.

Mercedes-Benz recommends that you have the wiper blades changed at a qualified specialist workshop.

Replacing the windscreen wipers

Removing the wiper blades

- ▶ **Vehicles without KEYLESS-GO or KEYLESS-GO start function:** remove the key from the ignition lock.
- ▶ **Vehicles with KEYLESS-GO or KEYLESS-GO start function:** switch off the engine.
- ▶ Fold the wiper arm away from the windscreen.

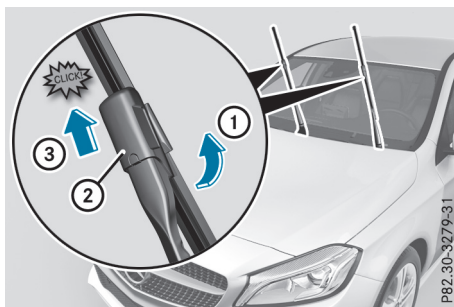

- ▶ Hold on to the wiper arm with one hand. With the other hand, turn the wiper blade in the direction of arrow ① away from the wiper arm as far as it will go.
- ▶ Slide catch ② in the direction of arrow ③ until it engages in the removal position with a noticeable click.

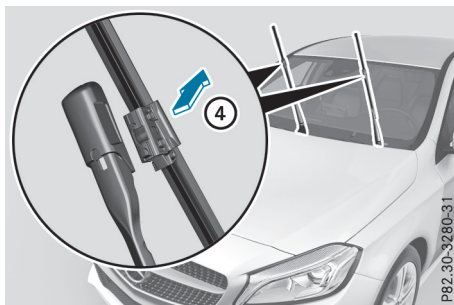

- ▶ Remove the wiper blade in the direction of arrow ④ away from the wiper arm.

Fitting the wiper blades

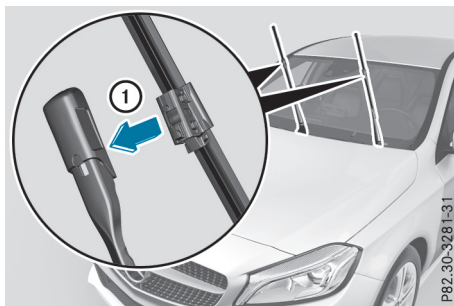

- ▶ Insert the new wiper blade into the wiper arm in the direction of arrow ①.

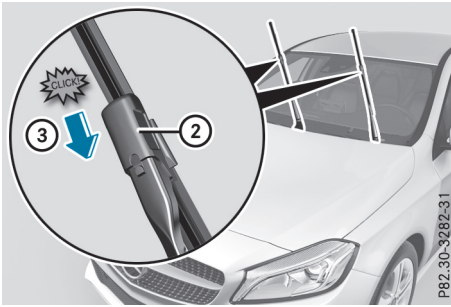

P82.30-3282-31

- ▶ Slide catch (2) in the direction of arrow (3) until it engages in the locking position with a noticeable click.
- ▶ Make sure that the wiper blade sits correctly.
- ▶ Fold the wiper arm back onto the windscreen.

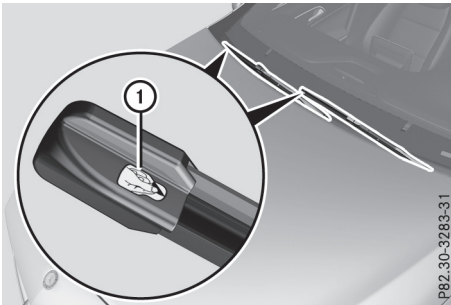

P82.30-3283-31

- ▶ Remove protective film (1) of the service indicator on the tip of the wiper blade.

If the colour of the service indicator changes from black to yellow, the wiper blades should be replaced.

- i** The duration of the colour change varies depending on the usage conditions.

Replacing the rear window wiper blade

Removing a wiper blade

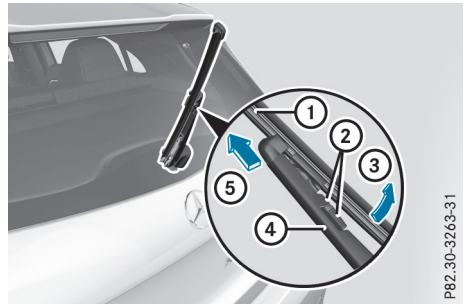

P82.30-3263-31

- ▶ **Vehicles without KEYLESS-GO or KEYLESS-GO start function:** remove the key from the ignition lock.
- ▶ **Vehicles with KEYLESS-GO or KEYLESS-GO start function:** switch off the engine.
- ▶ Fold wiper arm (4) away from the rear window.
- ▶ Press both release clips (2).
- ▶ Fold wiper blade (1) in the direction of arrow (3) away from wiper arm (4).
- ▶ Remove wiper blade (1) in the direction of arrow (5).

Fitting a wiper blade

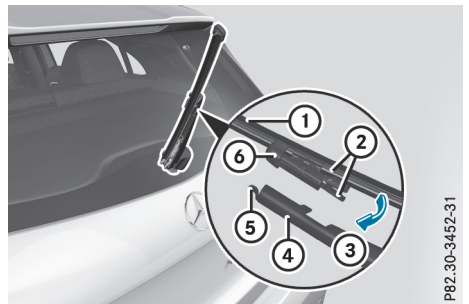

P82.30-3452-31

- ▶ Position new wiper blade (1) with recess (6) on lug (5).
- ▶ Fold wiper blade (1) in the direction of arrow (3) onto the wiper arm until retaining clips (2) engage in bracket (4).
- ▶ Make sure that wiper blade (1) is seated correctly.
- ▶ Fold the wiper arm back onto the rear window.

Problems with the windscreen wipers

Problem	Possible causes/consequences and ► Solutions
The windscreen wipers are jammed.	Leaves or snow, for example, may be obstructing windscreen wiper movement. The wiper motor has been deactivated. <ul style="list-style-type: none"> ► For safety reasons, you should remove the key from the ignition lock. ► Remove the cause of the obstruction. ► Switch the windscreen wipers back on.
The windscreen wipers fail completely.	The windscreen wiper drive is malfunctioning. <ul style="list-style-type: none"> ► Select another wiper speed on the combination switch. ► Have the windscreen wipers checked at a qualified specialist workshop.
The windscreen washer fluid from the spray nozzles no longer hits the centre of the windscreen.	The spray nozzles are misaligned. <ul style="list-style-type: none"> ► Have the spray nozzles adjusted at a qualified specialist workshop.

Overview of climate control systems

General notes

Observe the settings recommended on the following pages. Otherwise, the windows could mist up.

To prevent the windows from misting up:

- switch off climate control only briefly
- activate air-recirculation mode only briefly
- activate the "Cooling with air dehumidification" function
- activate the "Windscreen demisting" function briefly, if required

The air-conditioning system or THERMOTRONIC automatic climate control regulates the temperature and the humidity of the vehicle interior and filters undesirable substances from the air.

The air-conditioning system or THERMOTRONIC automatic climate control can only be operated when the engine is running. Optimum operation is only achieved with the side windows and panorama sliding sunroof closed.

The "Residual heat" function can only be switched on or off if the ignition is switched off (▷ page 128).

Always keep the ventilation flaps behind the side panelling clear (▷ page 113). Otherwise the vehicle will not be ventilated correctly.

- i** Ventilate the vehicle for a brief period during warm weather, e.g. using the convenience opening feature (▷ page 90). This will speed

up the cooling process and the desired interior temperature will be reached more quickly.

- i** The integrated filter filters out most particles of dust and soot and completely filters out pollen. With THERMOTRONIC automatic climate control, gaseous pollutants and odours will also be reduced. A clogged filter reduces the amount of air supplied to the vehicle interior. For this reason, you should always observe the interval for replacing the filter, which is specified in the Service Booklet. As this depends on environmental conditions, e.g. heavy air pollution, the interval may be shorter than stated in the Service Booklet.

- i** **Vehicles with auxiliary heating:** Under certain environmental conditions, the residual heat function may be activated automatically an hour after the ignition key has been removed in order to dry the automatic climate control. The blue LED on the rocker switch in the centre console lights up when the active function to dry the automatic climate control is on. The vehicle is then ventilated for 30 minutes.

Vehicles without auxiliary heating: Under certain environmental conditions, the residual heat function may be activated automatically an hour after the ignition key has been removed in order to dry the automatic climate control. The vehicle is then ventilated for 30 minutes.

Control panel for air-conditioning system

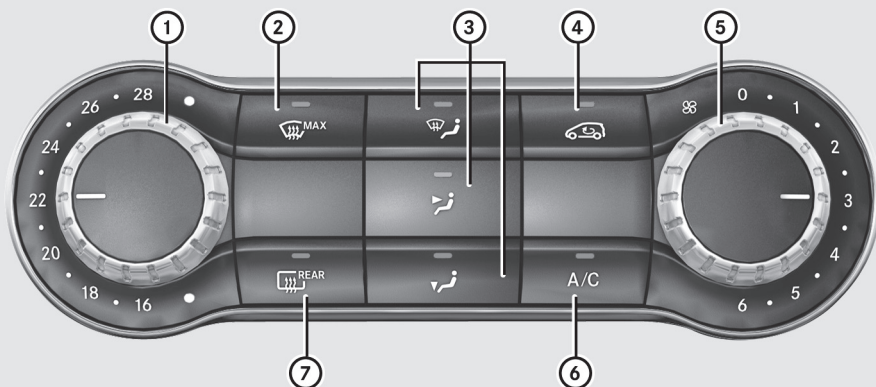

P83.40-4989-31

- ① To set the temperature (▷ page 124)
- ② To demist the windscreen (▷ page 125)
- ③ To set the air distribution (▷ page 124)
- ④ To activate/deactivate air-recirculation mode (▷ page 126)
- ⑤ To set the airflow (▷ page 125)
- ⑥ To activate/deactivate cooling with air dehumidification (▷ page 123)
- ⑦ To switch the rear window heating on/off (▷ page 126)

Notes on using the air-conditioning system

Air-conditioning system

Below, you can find a number of tips and recommendations for optimum use of the air-conditioning system.

- Switch on the air-conditioning system by turning control knob ⑤ clockwise to the desired position (except position 0).
- Set the temperature to 22 °C.

- **Recommendation for avoiding misted windows at low exterior temperatures or in rain:** switch on the cooling with dehumidification function (▷ page 123).

Set air distribution to and if possible switch off and (▷ page 124).

Deactivate air-recirculation mode (▷ page 126).

Set airflow control ⑤ to a setting between 3 and 6 (▷ page 125).

- **Recommendation for rapid cooling or heating of the vehicle interior:** briefly set airflow control ⑤ to a setting between 3 and 6 (▷ page 125).
- **Recommendation for a constant vehicle interior temperature:** set airflow control ⑤ to a setting between 1 and 3 (▷ page 125).
- **Recommendation for air distribution in winter:** select the and settings (▷ page 124).
- **Recommendation for air distribution in summer:** select the or and settings (▷ page 124).
- Use the "Windscreen demisting" function only briefly until the windscreen is clear again.
- Use the "Air-recirculation mode" function only briefly, e.g. if there are unpleasant outside odours or when in a tunnel. The windows could otherwise mist up as no fresh air is drawn into the vehicle in air-recirculation mode.
- If you change the settings of the climate control system, the climate status display

appears for approximately three seconds at the bottom of the screen on the multimedia system display; see Digital Owner's Manual. You will see the current settings of the various climate control functions.

DYNAMIC SELECT button (except Mercedes-AMG vehicles)

You can choose between various drive programs with the DYNAMIC SELECT button (▷ page 143).

If you have selected drive program **E**:

- when heating, the electrical heater booster is deactivated and in the warming-up phase heat output is reduced
- the rear window heating running time is reduced

Depending on the configuration, the climate settings can also be influenced in drive program **I**. If you have selected drive program **C** or **S**, the climate settings are not affected.

ECO start/stop function

During automatic engine stop, the climate control operates only at a reduced capacity. If you require the full climate control output, you can switch off the ECO start/stop function by pressing the ECO button (▷ page 140).

Control panel for THERMOTRONIC automatic climate control (2-zone)

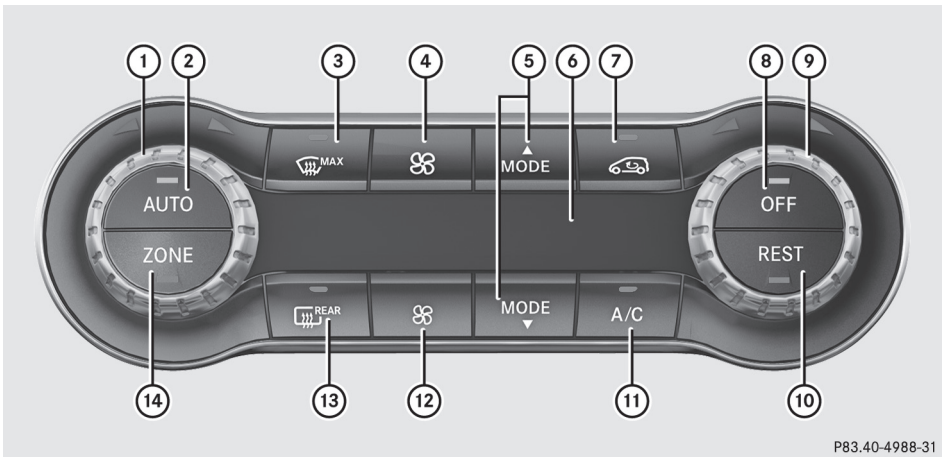

P83.40-4988-31

- ① Sets the temperature, left (▷ page 124)
- ② Sets climate control to automatic mode (▷ page 123)
- ③ Demists the windscreen (▷ page 125)
- ④ Increases the airflow (▷ page 125)
- ⑤ Sets the air distribution (▷ page 124)
- ⑥ Display
- ⑦ Activates/deactivates air-recirculation mode (▷ page 126)
- ⑧ Switches climate control on/off (▷ page 122)
- ⑨ Sets the temperature, right (▷ page 124)
- ⑩ Switches residual heat on/off (▷ page 128)
- ⑪ Activates/deactivates cooling with air dehumidification (▷ page 123)
- ⑫ Reduces the airflow (▷ page 125)

- ⑬ Switches the rear window heating on/off (▷ page 126)
- ⑭ Switches the ZONE function on/off (▷ page 125)

Information on operating THERMOTRONIC automatic climate control

Automatic climate control

The following contains instructions and recommendations to enable you to get the most out of your THERMOTRONIC automatic climate control.

- Activate climate control using the **AUTO** and **A/C** buttons. The indicator lamps in the **AUTO** and **A/C** buttons light up.
- Set the temperature to 22 °C.
- Use the "Windscreen demisting" function only briefly until the windscreen is clear again.
- Use the "Air-recirculation mode" function only briefly, e.g. if there are unpleasant outside odours or when in a tunnel. The windows could otherwise mist up as no fresh air is drawn into the vehicle in air-recirculation mode.
- Use the ZONE function to adopt the temperature settings on the driver's side for the front-passenger side as well. The indicator lamp in the **ZONE** button goes out.
- Use the "Residual heat" function if you want to heat or ventilate the vehicle interior when the ignition is switched off. The "Residual heat" function can be switched on or off only with the ignition switched off.
- If you change the settings of the climate control system, the climate status display appears for approximately three seconds at the bottom of the screen on the multimedia system display; see Digital Owner's Manual. You will see the current settings of the various climate control functions.

DYNAMIC SELECT button (except Mercedes-AMG vehicles)

You can choose between various drive programs with the DYNAMIC SELECT button (▷ page 143).

If you have selected drive program **E**:

- when heating, the electrical heater booster is deactivated and in the warming-up phase heat output is reduced
- the rear window heating running time is reduced

Depending on the configuration, the climate settings can also be influenced in drive program **I**.

If you have selected drive program **C** or **S**, the climate settings are not affected.

ECO start/stop function

During automatic engine stop, the climate control operates only at a reduced capacity. If you require the full climate control output, you can switch off the ECO start/stop function by pressing the ECO button (▷ page 140).

Operating the climate control systems

Switching climate control on/off

General notes

When climate control is switched off, the air supply and air circulation are also switched off. The windows could mist up. Therefore, switch off climate control only briefly.

Air-conditioning system

- ▶ Turn the key to position **2** in the ignition lock (▷ page 135).
- ▶ **To switch on:** turn control **5** clockwise to the desired position (except position **0**) (▷ page 120).
- ▶ **To switch off:** turn control **5** anti-clockwise to position **0** (▷ page 120).

THERMOTRONIC automatic climate control

- ▶ Turn the key to position **2** in the ignition lock (▷ page 135).
- ▶ **To activate:** press the **AUTO** button. The indicator lamp in the **AUTO** button lights up. Airflow and air distribution are set to automatic mode.

or

- ▶ Press the **OFF** button. The indicator lamp in the **OFF** button goes out. The previous settings are reactivated.
- ▶ **To deactivate:** press the **OFF** button. The indicator lamp in the **OFF** button lights up.

i THERMOTRONIC automatic climate control: switch on climate control primarily using the **AUTO** button.

Activating/deactivating cooling with air dehumidification

General notes

If you deactivate the "Cooling with air dehumidification" function, the air inside the vehicle will

not be cooled during warm weather. The air inside the vehicle will also not be dehumidified. The windows can mist up more quickly. Therefore, only deactivate the "Cooling with air dehumidification" function briefly.

The "Cooling with air dehumidification" function is available only when the engine is running. The air inside the vehicle is cooled and dehumidified according to the temperature selected.

Condensation may drip from the underside of the vehicle when cooling mode is active. This is normal and not a sign that there is a malfunction.

Activating/deactivating

- ▶ Press the **A/C** button. The indicator lamp in the **A/C** button lights up or goes out.

The indicator lamp in the button indicates that the respective function is activated. The cooling with air dehumidification function has a delayed switch-off feature.

Problems with the "Cooling with air dehumidification" function

Problem	Possible causes/consequences and ▶ Solutions
The indicator lamp in the A/C button flashes three times or remains off. The cooling with air dehumidification function cannot be activated.	The cooling with air dehumidification function has been deactivated due to a malfunction. ▶ Consult a qualified specialist workshop.

Setting climate control to automatic mode

General notes

Only THERMOTRONIC automatic climate control features the "Control climate control automatically" function.

In automatic mode, the set temperature is maintained automatically at a constant level. The system automatically regulates the temperature



of the dispensed air, the airflow and the air distribution.

The "Cooling with air dehumidification" function is activated automatically in automatic mode.

Setting climate control to automatic mode

- ▶ Turn the key to position ② in the ignition lock (▷ page 135).
- ▶ Set the desired temperature.
- ▶ **To activate:** press the **AUTO** button.
The indicator lamp in the **AUTO** button lights up. Automatic air distribution and airflow are activated.
- ▶ **To switch to manual mode:** press the **MODE** or **MODE** button.

or

- ▶ Press the  or  button.
The indicator lamp in the **AUTO** button goes out. Automatic air distribution and airflow are deactivated.

Setting the temperature

Air-conditioning system

You can set the temperature for the entire vehicle. The set temperature is automatically maintained at a constant level.

- ▶ Turn the key to position **2** in the ignition lock (▷ page 135).
- ▶ **To increase or reduce:** turn control ① anti-clockwise or clockwise (▷ page 120). Change the temperature setting only in small increments. Start at 22 °C.

THERMOTRONIC automatic climate control



Different temperatures can be set for the driver's and front-passenger sides. The set temperature is automatically maintained at a constant level.

- ▶ Turn the key to position **2** in the ignition lock (▷ page 135).
- ▶ **To increase or decrease:** turn control ① or ② anti-clockwise or clockwise (▷ page 121). Change the temperature setting only in small increments. Start at 22 °C.

Setting the air distribution

Air-conditioning system



Air distribution settings

-  Directs the airflow through the demister vents
-  Directs the airflow through the centre and side air vents
-  Directs the airflow through the footwell air vents

i You can also activate several of the air distribution settings simultaneously. In order to do this, press several of the air distribution buttons. The air is then routed through different air vents.







i Regardless of the air distribution setting, airflow is always directed through the side air vents. The side air vents can only be closed if the adjusters are turned clockwise until they engage.

Setting the air distribution

- ▶ Turn the key to position ② in the ignition lock (▷ page 135).
- ▶ Press one or more of the , ,  buttons.
The corresponding indicator lamp comes on.

THERMOTRONIC automatic climate control

Air distribution settings

-  Directs the airflow through the demister vents
-  Directs the airflow through the centre and side air vents
-  Directs the airflow through the footwell air vents
-  Directs the airflow through the centre and side air vents as well as the footwell air vents
-  Directs the airflow through the centre and side air vents as well as the demister vents
-  Directs the airflow through the footwell and demister vents
-  Directs the airflow through the demister vents, the centre and side air vents as well as the footwell air vents

- i** Regardless of the air distribution setting, airflow is always directed through the side air vents. The side air vents can only be closed if the adjusters are turned clockwise until they engage.

Setting the air distribution



- ▶ Turn the key to position **2** in the ignition lock (▷ page 135).
- ▶ Press the **MODE** or **MODE** button repeatedly until the required symbol appears in the display.

Setting the airflow

Air-conditioning system

- ▶ Turn the key to position **2** in the ignition lock (▷ page 135).
- ▶ **To increase or reduce:** turn control **5** anti-clockwise or clockwise (▷ page 120).

THERMOTRONIC automatic climate control

- ▶ Turn the key to position **2** in the ignition lock (▷ page 135).
- ▶ **To increase or reduce:** press the  or  button.

Switching the ZONE function on/off

This function is only available with THERMOTRONIC automatic climate control.

- ▶ **To activate:** press the **ZONE** button. The indicator lamp in the **ZONE** button lights up. The temperature setting for the driver's side is not adopted for the front-passenger side.
- ▶ **To deactivate:** press the **ZONE** button. The indicator lamp in the **ZONE** button goes out. The temperature setting for the driver's side is adopted for the front-passenger side.

Demisting the windscreen

General notes

You can use this function to defrost the windscreen or to demist the inside of the windscreen and the side windows.

- i** You should only select the "Windscreen demisting" function until the windscreen is clear again.

Switching the "Windscreen demisting" function on or off

- ▶ Turn the key to position **2** in the ignition lock (▷ page 135).

- ▶ **To activate:** press the  button.



The indicator lamp in the  button lights up.



The climate control system switches to the following functions:

- high airflow
- high temperature
- air distribution to the windscreen and front side windows
- air-recirculation mode off

- i** The "Windscreen demisting" function automatically sets the blower level to the optimum demisting effect. As a result, the airflow may increase or decrease automatically after the  button is pressed.

- i** You can adjust the blower level manually while the "Windscreen demisting" function is in operation:

- Air-conditioning system: turn airflow control **5** anti-clockwise or clockwise (▷ page 120).
- THERMOTRONIC automatic climate control: press the  or  button.

- ▶ **To deactivate:** press the  button. The indicator lamp in the  button goes out. The previous settings are reactivated. "Air-recirculation" mode remains deactivated.

or

- ▶ THERMOTRONIC automatic climate control: press the **AUTO** button. The indicator lamp in the  button goes out. Airflow and air distribution are set to automatic mode.

or



- ▶ Air-conditioning system: turn temperature control ① anti-clockwise or clockwise (▷ page 120).

THERMOTRONIC automatic climate control: turn temperature control ① or ⑨ anti-clockwise or clockwise (▷ page 121).

Demisting the windows



Windows misted up on the inside

Air-conditioning system

- ▶ Activate the  "Cooling with air dehumidification" function.
- ▶ If the windows continue to mist up, activate the  "Windscreen demisting" function.

i You should only select this setting until the windscreen is clear again.

THERMOTRONIC automatic climate control

- ▶ Activate the  "Cooling with air dehumidification" function.
- ▶ Activate automatic mode .
- ▶ If the windows continue to mist up, activate the  "Windscreen demisting" function.

i You should only select this setting until the windscreen is clear again.

Problems with the rear window heating



Problem	Possible causes/consequences and ► Solutions
The rear window heating has switched off prematurely or cannot be switched on.	The battery has not been sufficiently charged. ► Switch off any consumers that are not required, e.g. reading lamps, interior lighting or the seat heating. When the battery is sufficiently charged, the rear window heating can be switched on again.

Activating/deactivating air-recirculation mode

General notes

You can deactivate the flow of fresh air temporarily if unpleasant odours are entering the vehicle from outside. The air already inside the vehicle will then be recirculated.

Windows misted up on the outside

- ▶ Activate the windscreen wipers.
- ▶ Set the air distribution to  or .

i You should only select this setting until the windscreen is clear again.



Rear window heating

General notes

The rear window heating has a high current draw. You should therefore switch it off as soon as the window is clear. The rear window heating otherwise switches off automatically after several minutes.

If the battery voltage is too low, the rear window heating may switch off.



Switching on/off

- ▶ Turn the key to position  in the ignition lock (▷ page 135).
- ▶ Press the  button. The indicator lamp in the  button lights up or goes out.

If you activate air-recirculation mode, the windows can mist up more quickly, particularly at low temperatures. Activate air-recirculation mode only briefly to prevent the windows from misting up.

The operation of air-recirculation mode is the same for all control panels.



Switching on/off

- ▶ Turn the key to position **2** in the ignition lock (▷ page 135).
- ▶ **To activate:** press the  button. The indicator lamp in the  button lights up.

THERMOTRONIC automatic climate control: air-recirculation mode is activated automatically:

- at high outside temperatures
- at high levels of pollution

When air-recirculation mode is activated automatically, the indicator lamp in the  button is not lit. Outside air is added after about 30 minutes.

- ▶ **To deactivate:** press the  button. The indicator lamp in the  button goes out.

- i** "Air-recirculation" mode is deactivated automatically:
 - after approximately five minutes at outside temperatures below approximately 7 °C
 - after approximately five minutes if the "Cooling with air dehumidification" function is deactivated
 - after approximately 30 minutes at outside temperatures above approximately 7 °C if the "Cooling with dehumidification" function is activated

Convenience opening or closing using the air-recirculation button

WARNING



When the convenience closing feature is operating, parts of the body could become trapped in the closing area of the side window and the sliding sunroof. There is a risk of injury.

Observe the complete closing procedure when the convenience closing feature is operating. When closing make sure that no parts of the body are in the closing area.

WARNING

During convenience opening parts of the body could be drawn in or become trapped

between the side window and window frame. There is a risk of injury.



When opening, make sure that nobody is touching the side window. If someone becomes trapped, immediately press the  switch in the door to stop the movement of the side windows. To continue closing the side window, pull on the  switch.

- ▶ **Convenience closing feature:** press and hold the  button until the side windows start to close automatically.



Vehicles with panorama sliding sunroof: the sliding sunroof or panorama sliding sunroof closes simultaneously.

The indicator lamp in the  button lights up. Air-recirculation mode is activated.

If parts of the body are in the closing area during convenience closing, proceed as follows:

- ▶ Press the  button to stop the side windows. The side windows stop.
- ▶ To then open the side window, press the  button again.

or

- ▶ Press and hold the  button again for at least two seconds. The side windows move in the opposite direction.
- ▶ **Only vehicles with panorama sliding sunroof:** press the  switch to stop the panorama sliding sunroof. The panorama sliding sunroof stops.
- ▶ To then open the panorama sliding sunroof, pull back on the  switch.

- i** Observe the notes on the automatic reversing feature for:

- the side windows (▷ page 89)
- the panorama sliding sunroof (▷ page 93)

- ▶ **Convenience opening feature:** press and hold the  button until the side windows start to open automatically.

Vehicles with panorama sliding sunroof: the panorama sliding sunroof opens simultaneously.

The indicator lamp in the  button goes out. Air-recirculation mode is deactivated.

- i** If you open the side windows or the panorama sliding sunroof manually after closing

with the convenience closing feature, they will remain in this position when opened using the convenience opening feature.

Switching residual heat on/off

General notes

The residual heat function is only available with THERMOTRONIC automatic climate control.

It is possible to make use of the residual heat of the engine to continue heating the vehicle for approximately 30 minutes after the engine has been switched off. The heating time depends on the set interior temperature.

- i** The blower will run at a low speed regardless of the airflow setting.
- i** If you switch on the "Residual heat" function at high temperatures, only the ventilation will be activated. The blower runs at medium speed.
- i** You cannot use the ventilation to cool the vehicle interior to a temperature lower than the outside temperature.

Activating/deactivating

- ▶ Turn the key to position **0** in the ignition lock or remove it (> page 135).
- ▶ Press the **REST** button. The indicator lamp in the **REST** button lights up or goes out. The indicator lamp in the button indicates that the respective function is activated.
- i** Residual heat is switched off automatically:
 - after approximately 30 minutes
 - when the ignition is switched on
 - if the battery voltage drops
 - when the auxiliary heating is switched on

Auxiliary heating

Important safety notes

DANGER

If the exhaust pipe is blocked or sufficient ventilation is not possible, toxic exhaust fumes can enter the vehicle, especially car-

bon monoxide. This is the case, e.g. in enclosed spaces, or if the vehicle is stuck in snow. There is a risk of fatal injuries.

You should switch off the auxiliary heating in enclosed spaces which do not have an extraction system, e.g. a garage. If the vehicle is stuck in snow and you must leave the auxiliary heating running, keep the exhaust pipe and the area around the vehicle clear of snow. To guarantee a sufficient supply of fresh air, open a window on the side of the vehicle away from the wind.

WARNING

When the auxiliary heating is switched on, parts of the vehicle can become very hot.

Flammable materials such as leaves, grass or twigs may ignite if they come into contact with:

- hot parts of the exhaust system
- the exhaust gas itself

There is a risk of fire.

When the auxiliary heating is switched on, make sure that:

- no flammable materials come into contact with hot vehicle components
- the exhaust gas can escape from the exhaust pipe unhindered
- the exhaust gas does not come into contact with flammable materials.

The auxiliary heating and the exhaust gas outlet are situated in front of the right-hand front wheel.

! Operating the auxiliary heating/ventilation draws on the vehicle battery. After you have heated or ventilated the vehicle a maximum of two times, drive for a longer distance.

Switch the auxiliary heating on regularly – once a month – for about ten minutes.

The auxiliary heating timer function calculates the switch-on time according to the outside temperature so that the vehicle is preheated by the departure time. When the departure time is reached, the auxiliary heating continues to heat for a further five minutes and then switches off.

The auxiliary heating heats the air in the vehicle interior to the set temperature. This occurs without using the heat of the running engine. The auxiliary heating is operated directly using the vehicle's fuel. For this reason, the fuel tank must be at least $\frac{1}{4}$ full to ensure that the auxiliary heating functions.

The auxiliary heating/ventilation automatically adjusts to changes in temperature and weather conditions. For this reason, the auxiliary heating could switch from ventilation mode to heating mode or from heating mode to ventilation mode.

The auxiliary heating switches off when the engine is switched off. The auxiliary ventilation switches off when you turn the key to key position **2** (▷ page 135).

The auxiliary heating switches off automatically after 50 minutes.

You cannot use the auxiliary ventilation to cool the vehicle interior to a temperature lower than the outside temperature.

Before switching on

- ▶ Turn the key to position **2** in the ignition lock (▷ page 135).
- ▶ Set the desired temperature.

Auxiliary heating or ventilation can also be switched on if the manually set climate control is activated. Optimum comfort is attained by setting the system to automatic mode. Set the temperature to 22 °C.

The auxiliary heating or auxiliary ventilation can be switched on/off using the button on the centre console or the remote control.

The on-board computer can be used to specify up to three departure times, one of which may be preselected (▷ page 213).

Switching the auxiliary heating/ventilation on or off using the button on the centre console

General notes



The colours of the indicator lamps on button **1** signify the following:

- **Blue:** auxiliary ventilation activated
- **Red:** auxiliary heating activated
- **Yellow:** departure time preselected (▷ page 213)

Activating/deactivating the auxiliary heating or auxiliary ventilation

- ▶ Press button **1**.
The red or blue indicator lamp in button **1** lights up or goes out.

Switching the auxiliary heating/ventilation on or off using the remote control

General notes

Your vehicle comes with one remote control. You may use two additional remote controls for your vehicle. For more information, please contact a qualified specialist workshop.

Store the remote control for the auxiliary heating so that the auxiliary heating cannot be switched on unintentionally. In particular, ensure that the remote control for the auxiliary heating is kept out of the reach of children.

The remote control has a range of approximately 300 metres. This range is reduced by:

- sources of radio interference
- solid objects between the remote control and the vehicle

- the remote control being in an unfavourable position in relation to the vehicle
- transmitting from an enclosed space

If the remote control battery is low, the battery symbol on the left of the display is shown as empty. Replace the remote control battery and observe the important safety notes when doing so (▷ page 131).

Activating/deactivating the auxiliary heating or auxiliary ventilation

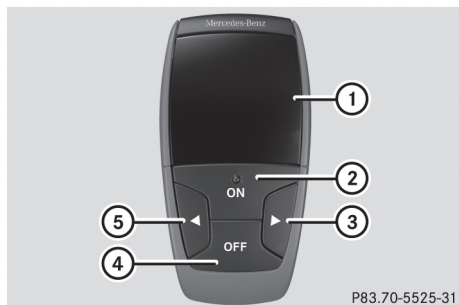

Remote control

- ① Display
- ② **ON** Switches on the auxiliary heating or auxiliary ventilation
Checks the status
- ③ **▶** Sets the departure time
- ④ **OFF** Switches the auxiliary heating or auxiliary ventilation off
- ⑤ **◀** Sets the departure time

- ▶ **To switch on:** press and hold the **ON** button.
ON is shown on the remote control display.
- ▶ **To switch off:** press and hold the **OFF** button.
OFF is shown on the remote control display.

Checking the status of the auxiliary heating or auxiliary ventilation

- ▶ Briefly press the **ON** button.

The following messages may appear on the display:

Display	Meaning
	The auxiliary heating or auxiliary ventilation is switched off.

	The auxiliary ventilation is switched on. The number on the display shows the remaining time (in minutes) for the auxiliary ventilation.
	The auxiliary heating is switched on. The number on the display shows the remaining time (in minutes) for the auxiliary heating.
	A departure time has been activated. The departure time appears on the display.
	A departure time has been activated. The auxiliary ventilation is currently switched on. The number on the display shows the remaining time (in minutes) for the auxiliary ventilation. If the vehicle is not started after this time, the running time is increased by five minutes.
	A departure time has been activated. The auxiliary heating is currently switched on. The number on the display shows the remaining time (in minutes) for the auxiliary heating. If the vehicle is not started after this time, the running time is increased by five minutes.

If the engine has not yet reached operating temperature when it is started, the auxiliary heating running time is increased. The auxiliary heating continues to run until the operating temperature is reached. If this is the case, the symbol appears on the remote control display and the running time is zero minutes.

Setting the departure time

Make sure that the time set in the vehicle is correct before setting the departure time (see the Digital Owner's Manual). Otherwise, the auxiliary heating may switch on at the wrong time

and at an unsuitable location. When setting the departure time, observe the important safety notes (▷ page 128).

- ▶ Briefly press the **ON** button.
- ▶ Press the **◀** or **▶** button repeatedly until the time to be changed appears in the display.
- ▶ Press the **ON** and **OFF** buttons at the same time.
The  symbol in the remote control display flashes.
- ▶ Press the **◀** or **▶** button to set the desired departure time.
- i** The longer you press the **◀** or **▶** button, the faster the time changes.
- ▶ Press the **ON** and **OFF** buttons at the same time.
The new departure time is stored.

Activating the set departure time

- ▶ Briefly press the **ON** button.
- ▶ Press the **◀** or **▶** button repeatedly until the desired departure time appears in the display.
- ▶ Press the **ON** button.
The  symbol, the departure time and, depending on the selected departure time, the letter **A**, **B** or **C** appear in the display.

Deactivating the set departure time

- ▶ Briefly press the **ON** button.
The status of the auxiliary heating is shown on the display.
- ▶ Press the **▶** button.
The first departure time stored appears on the display.
- ▶ Press the **OFF** button.
OFF is shown on the remote control display.

Replacing the remote control battery

Important safety notes

WARNING

Batteries contain toxic and corrosive substances. If batteries are swallowed, it can result in severe health problems. There is a risk of fatal injury.

Keep batteries out of the reach of children. If a battery is swallowed, seek medical attention immediately.

Environmental note



Batteries contain pollutants. It is illegal to dispose of them with the household rubbish. They must be collected separately and disposed of in an environmentally responsible recycling system.



Dispose of batteries in an environmentally responsible manner. Take discharged batteries to a qualified specialist workshop or to a collection point for used batteries.

Replacing the battery

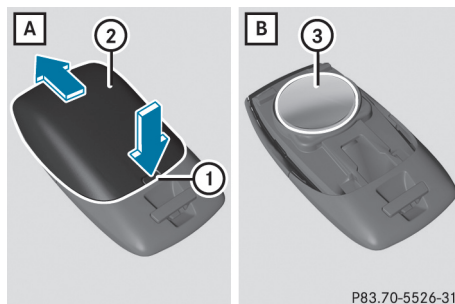

A CR2450 lithium battery is required when replacing the battery.

- ▶ Press a pointed object into recess ①.
- ▶ Slide battery cover ② backwards in the direction of the arrow.
- ▶ Insert new battery ③ with the lettering facing upwards.
- ▶ Slide battery cover ② in the opposite direction to the arrow on the remote control until it engages.

P83.70-5526-31

Problems with the auxiliary heating/ventilation

Problem	Possible causes/consequences and ► Solutions
FAIL 	<p>The signal transmission between the transmitter and the vehicle is faulty.</p> <ul style="list-style-type: none"> ► Change your position in relation to the vehicle, moving closer if necessary. ► Make another attempt to switch the auxiliary heating/ventilation on or off using the remote control.
FAIL	<p>The auxiliary heating cannot be switched on or has switched itself off. The starter battery is not sufficiently charged.</p> <ul style="list-style-type: none"> ► Charge the starter battery. ► Make another attempt to switch on the auxiliary heating/ventilation using the remote control.
	<p>The auxiliary heating cannot be switched on or has switched itself off. The fuel tank content is below the reserve fuel level.</p> <ul style="list-style-type: none"> ► Refuel at the nearest filling station. ► Make another attempt to switch on the auxiliary heating using the remote control.
	<p>The auxiliary heating/ventilation cannot be switched on or has switched itself off.</p> <p>The auxiliary heating/ventilation is malfunctioning.</p> <ul style="list-style-type: none"> ► Have the auxiliary heating/ventilation checked at a qualified specialist workshop.

Air vents

Important safety notes

WARNING

Very hot or very cold air can flow from the air vents. This could result in burns or frostbite in the immediate vicinity of the air vents. There is a risk of injury.

Make sure that all vehicle occupants always maintain a sufficient distance to the air outlets. If necessary, redirect the airflow to another area of the vehicle interior.

In order to ensure the direct flow of fresh air through the air vents into the vehicle interior, please observe the following notes:

- keep the air inlet between the windscreen and the bonnet free of blockages, such as ice, snow or leaves
- never cover the vents or ventilation grilles in the vehicle interior

 Optimal climate control function is achieved by opening the air vents fully and setting the adjusters to the middle position.

Adjusting the air vents

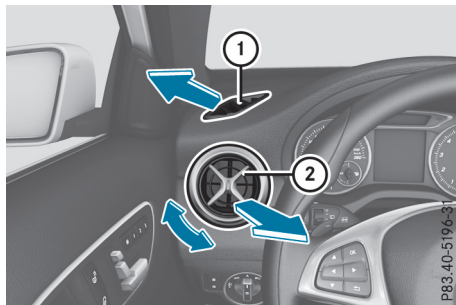

- ① Side window demister vent
- ② Side air vent

- ▶ **To open a side air vent:** turn the adjuster in side air vent ② anti-clockwise.
 - ▶ **To close a side air vent:** turn the adjuster in side air vent ② clockwise as far as it will go.
- i** The centre and rear air vents are adjusted in the same way.

Running-in notes

Important safety notes

In certain driving and driving safety systems, the sensors adjust automatically while a certain distance is being driven after the vehicle has been delivered or after repairs. Full system effectiveness is not reached until the end of this teach-in process.

Brake pads/linings and discs that are either new or have been replaced only achieve optimum braking effect after several hundred kilometres of driving. Compensate for the reduced braking effect by applying greater force to the brake pedal.

The first 1500 km

The more you treat the engine with sufficient care at the start, the more satisfied you will be with the engine performance later on.

- Drive at varying vehicle speeds and engine speeds for the first 1500 km.
- Avoid overstraining the vehicle during this period, e.g. driving at full throttle.
- Change gear in good time, before the rev counter needle is $\frac{2}{3}$ of the way to the red area of the rev counter.
- Do not shift down a gear manually in order to brake.
- **Vehicles with automatic transmission:** try to avoid depressing the accelerator pedal beyond the point of resistance (kickdown).

Additional notes on running in Mercedes-AMG vehicles:

- for the first 1,500 km do not drive at speeds above 140 km/h.
- only allow the engine to reach a maximum engine speed of 4,500 rpm briefly.

After 1,500 km, you may gradually bring the vehicle up to full road and engine speeds.

You should also observe these notes on running-in if the engine or parts of the drive train on your vehicle have been replaced.

Always observe the maximum permissible speed.

Driving

Important safety notes

WARNING

Objects in the driver's footwell may restrict the clearance around the pedals or block a depressed pedal. This jeopardises the operating and road safety of the vehicle. There is a risk of an accident.

Stow all objects securely in the vehicle so that they do not get into the driver's footwell.

Always fit the floor mats securely and as prescribed in order to ensure that there is always sufficient room for the pedals. Do not use loose floor mats and do not place several floor mats on top of one another.

WARNING

Unsuitable footwear can hinder correct usage of the pedals, e.g.:

- shoes with thick soles
- shoes with high heels
- slippers

There is a risk of an accident.

Wear suitable footwear to ensure correct usage of the pedals.

WARNING

If you switch off the ignition while driving, safety-relevant functions are only available with limitations, or not at all. This could affect, for example, the power steering and the brake boosting effect. You will require considerably more effort to steer and brake. There is a risk of an accident.

Do not switch off the ignition while driving.

WARNING

If the parking brake has not been fully released when driving, the parking brake can:

- overheat and cause a fire
- lose its hold function.

There is a risk of fire and an accident. Release the parking brake fully before driving off.

! Do not warm up the engine while stationary. Pull away immediately. Avoid high engine speeds and full throttle until the engine has reached its operating temperature.

In vehicles with automatic transmission, engage positions P and R only when the vehicle is stationary.

Where possible, avoid spinning the drive wheels when pulling away on slippery roads. You could otherwise damage the drive train.

! **Mercedes-AMG vehicles:** avoid full-load operation and engine speeds greater than 5000 rpm when the engine is cold. This will help to protect the engine and maintain smooth engine operation.

Key positions

Keys

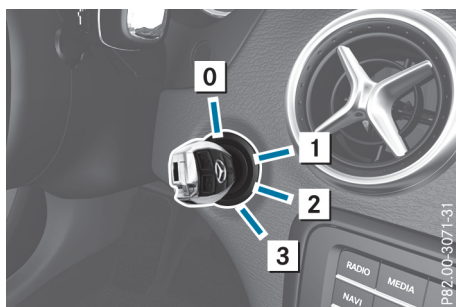

- 0** To remove the key
- 1** Power supply for some consumers, such as the windscreen wipers
- 2** Ignition (power supply for all consumers) and drive position
- 3** To start the vehicle

Vehicles with manual transmission: the steering is locked when the key is taken out of the ignition lock.

i If the key does not belong to the vehicle, it can still be turned in the ignition lock. However, the ignition will not be switched on. The engine cannot be started.

Start/Stop button

General notes

Vehicles with KEYLESS-GO are equipped with keys featuring an integrated KEYLESS-GO function and a detachable Start/Stop button.

A check that periodically establishes a radio connection between the vehicle and the key determines whether a valid key is in the vehicle. This occurs, for example, when the engine is started.

When you insert the Start/Stop button in the ignition lock, the system needs approximately two seconds of recognition time. You can then use the Start/Stop button.

Pressing the Start/Stop button several times in succession corresponds to the different key positions in the ignition lock. Pre-requisite for this is that:

- you do not depress the brake pedal (vehicles with automatic transmission)
- you do not depress the clutch pedal (vehicles with manual transmission)

If you depress the brake pedal and press the Start/Stop button, the engine starts immediately (vehicles with automatic transmission).

If you depress the clutch pedal and press the Start/Stop button, the engine starts immediately (vehicles with manual transmission).

To start the vehicle without actively using the key:

- the Start/Stop button must be inserted in the ignition lock
- the key must be in the vehicle
- the vehicle must not be locked with the key or KEYLESS-GO (▷ page 77)

Do not keep the KEYLESS-GO key:

- with electronic devices, e.g. a mobile phone or another key
- with metallic objects, e.g. coins or metal foil
- inside metallic objects, e.g. a metal case

This can affect the functionality of KEYLESS-GO.

If you lock the vehicle with the key's remote control or with KEYLESS-GO, after a short time:

- you will no longer be able to switch on the ignition with the Start/Stop button
- you will no longer be able to start the engine with the Start/Stop button until the vehicle is unlocked again

If you lock the vehicle centrally using the button on the front door (> page 84), you can continue to start the engine with the Start/Stop button. You can switch off the engine while the vehicle is in motion by pressing and holding the Start/Stop button for around three seconds. This function operates independently of the ECO start/stop automatic engine switch-off function.

Key positions with the Start/Stop button

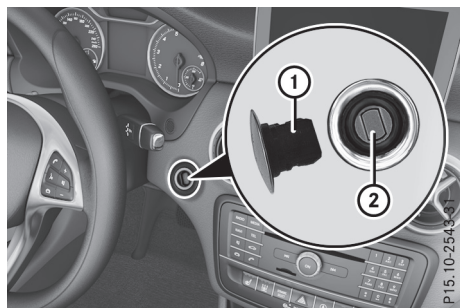

- ① Start/Stop button
- ② Ignition lock

When you switch on the ignition, all the indicator lamps on the instrument cluster light up.

For further information on situations in which an indicator lamp either fails to go out after the engine is started or lights up while driving, please refer to "Warning and indicator lamps in the instrument cluster" (> page 250).

If Start/Stop button ① has not yet been pressed, this corresponds to the key being removed from the ignition.

- ▶ **To switch on the power supply:** press Start/Stop button ① once. The power supply is switched on. You can now activate the windscreen wipers, for example.

The power supply is switched off again if:

- the driver's door is opened and
 - you press Start/Stop button ① twice when in this position
- ▶ **To switch on the ignition:** press Start/Stop button ① twice. The ignition is switched on. If you press Start/Stop button ① once when in this position, the ignition is deactivated again.

Removing the Start/Stop button

You can remove the Start/Stop button from the ignition lock and start the vehicle as normal using the key.

You can only switch between Start/Stop button mode and key operation when the vehicle is stationary.

You must also engage park position **P** (vehicles with automatic transmission).

- ▶ Remove Start/Stop button ① from ignition lock ②.

You do not have to remove the Start/Stop button from the ignition lock when you leave the vehicle. You should, however, always take the key with you when leaving the vehicle. As long as the key is in the vehicle:

- the vehicle can be started using the Start/Stop button
- the electrically powered equipment can be operated

Starting the vehicle

Important safety notes

WARNING

If children are left unsupervised in the vehicle, they could:

- open doors, thereby endangering other persons or road users
- get out and be struck by oncoming traffic
- operate vehicle equipment and become trapped, for example

In addition, the children could also set the vehicle in motion, for example, if they:

- release the parking brake
- shift the automatic transmission out of park position **P** or shift manual transmission into neutral
- start the engine.

There is a risk of an accident and injury.

When leaving the vehicle, always take the key with you and lock the vehicle. This also applies to mobile phones if the "Digital Car Key in smartphone" function is activated via the Mercedes me connect web app. Never leave

children and animals unattended in the vehicle.

Keep the keys out of the reach of children. This also applies to mobile phones if the "Digital Car Key in smartphone" function is activated via the Mercedes me connect web app.

WARNING

Combustion engines emit poisonous exhaust gases such as carbon monoxide. Inhaling these exhaust gases leads to poisoning. There is a risk of fatal injury. Therefore never leave the engine running in enclosed spaces without sufficient ventilation.

WARNING

Flammable materials introduced through environmental influence or by animals can ignite if in contact with the exhaust system or parts of the engine that heat up. There is a risk of fire.

Carry out regular checks to make sure that there are no flammable foreign materials in the engine compartment or in the exhaust system.

General notes

Vehicles with a petrol engine: the engine runs at a higher engine speed during the cold start procedure so that the catalytic converter can reach operating temperature more quickly. The sound of the engine may change as a result.

Manual transmission

You can only start the engine when the clutch pedal is fully depressed.

- ▶ Depress the brake pedal and keep it depressed.
- ▶ Depress the clutch pedal fully.
- ▶ Engage neutral **[N]**.

Automatic transmission

- ▶ Shift the transmission to position **[P]** (> page 146).
The transmission position indicator on the multifunction display shows **[P]** (> page 146).

- i** You can start the engine in transmission positions **[P]** and **[N]**.

Starting procedure using the key

To start the engine using the key instead of the Start/Stop button, pull the Start/Stop button out of the ignition lock.

- ▶ **To start a diesel engine:** turn the key to position **[2]** in the ignition lock (> page 135). The **[000]** preglow indicator lamp on the instrument cluster lights up.
- ▶ Turn the key to position **[3]** in the ignition lock (> page 135) and release it as soon as the engine is running.

Starting procedure using the Start/Stop button

The Start/Stop button can be used to start the vehicle manually without inserting the key in the ignition lock. The key must be in the vehicle and the Start/Stop button must be inserted in the ignition lock. This mode for starting the engine manually operates independently of the ECO start/stop automatic engine start function.

You can start the engine if a valid key is in the vehicle. Switch off the engine and always take the key with you when leaving the vehicle, even if you leave it for only a short time. Observe the important safety notes.

- ▶ **Vehicles with automatic transmission:**
depress the brake pedal and keep it depressed.
- ▶ **Vehicles with manual transmission:**
depress the clutch pedal and keep it depressed.
- ▶ Press the Start/Stop button once (> page 135).
Vehicles with a petrol engine: the engine starts.
Vehicles with a diesel engine: preglow is activated and the engine starts.

Pulling away

General notes

WARNING

Vehicles with automatic transmission:

If the engine speed is above the engine idling speed and you then engage transmission position **D** or **R**, the vehicle may accelerate suddenly. There is a risk of an accident.

When engaging transmission position **D** or **R**, always keep the brake pedal firmly depressed and do not depress the accelerator pedal at the same time.

! Vehicles with manual transmission:

change gear in good time and avoid spinning the wheels. You could otherwise damage the vehicle.

Depress the accelerator carefully when pulling away.

The vehicle automatically locks centrally once you have pulled away. The locking knobs in the doors drop down.

You can open the doors from the inside at any time.

You can also deactivate the automatic locking feature (▷ page 213).

It is possible to shift the transmission from position **P** to the desired position only if you depress the brake pedal. Only then can the parking lock be deactivated.

All vehicles (except Mercedes-AMG vehicles): if you do not depress the brake pedal, the DIRECT SELECT lever can still be moved but the parking lock remains engaged.

Mercedes-AMG vehicles: if you do not depress the brake pedal, the selector lever can still be moved but the parking lock remains engaged.

At transmission fluid temperatures below $-20\text{ }^{\circ}\text{C}$, you can shift out of position **P** into another transmission position only when the engine is running.



- i** Upshifts take place at higher engine speeds after a cold start. This helps the catalytic converter to reach its operating temperature more quickly.

Information on automatically releasing the electric parking brake (▷ page 160).

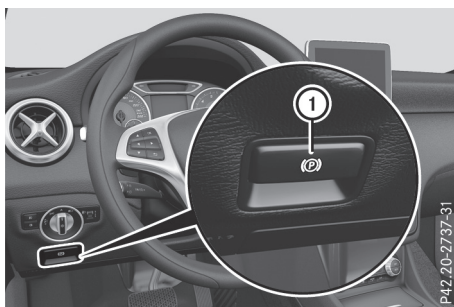
Pulling away with a trailer



To ensure that you do not roll backwards when pulling away on an uphill slope, apply the electric parking brake.

- ▶ Press and hold handle ①.
 - The electric parking brake continues to brake and prevents the vehicle from rolling backwards.
 - The red  indicator lamp in the instrument cluster remains lit.
- ▶ Depress the accelerator pedal.
- ▶ As soon as the vehicle/trailer combination is held by the driving force of the engine, release handle ①.
 - the electric parking brake is released
 - The red  indicator lamp in the instrument cluster goes out.

Further information on the electric parking brake (▷ page 158).

Hill start assist

Hill start assist helps you when pulling away forwards or in reverse on an uphill gradient. It holds the vehicle for a short time after you have removed your foot from the brake pedal. This gives you enough time to move your foot from the brake pedal to the accelerator pedal and depress it before the vehicle begins to roll.

WARNING

After a while, hill start assist no longer holds the vehicle and it may roll away. There is a risk of an accident and injury.

Therefore, quickly move your foot from the brake pedal to the accelerator pedal. Never leave the vehicle when it is held by hill start assist.

Hill start assist is not active if:

- you are pulling away on a level road or a downhill gradient
- the transmission is in position **N** on vehicles with automatic transmission
- the electric parking brake is applied
- ESP® is malfunctioning

Further information on holding the vehicle stationary on uphill gradients (▷ page 149).

ECO start/stop function

Introduction

The ECO start/stop function switches the engine off automatically if the vehicle is stopped under certain conditions.

When the vehicle pulls away again, the engine starts automatically. The ECO start/stop function thereby helps you to reduce the fuel consumption and emissions of your vehicle.

Important safety notes

WARNING

If the engine is switched off automatically and you exit the vehicle, the engine is restarted automatically. The vehicle may begin moving. There is a risk of accident and injury.

If you wish to exit the vehicle, always turn off the ignition and secure the vehicle against rolling away.

General notes

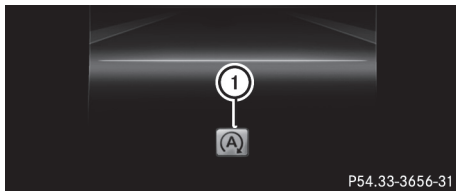



P54.33-3656-31

① ECO start/stop display

The ECO start/stop function is switched on whenever you start the engine using the key or the Start/Stop button.

If the  ECO symbol is shown on the multifunction display, the ECO start/stop function

switches the engine off automatically if the vehicle stops moving.

If the ECO start/stop function has been manually switched off (▷ page 140) or a malfunction has caused the system to be switched off, the  or  ECO symbol is not displayed.

Mercedes-AMG vehicles: the ECO start/stop function is available only in drive program **C**.



Automatic engine stop

General notes

The ECO start/stop function is operational and the  ECO symbol is displayed on the multifunction display if:

- the indicator lamp in the ECO button is lit green
- the outside temperature is within the range that is suitable for the system
- the engine is at normal operating temperature
- the set temperature for the vehicle interior has been reached
- the battery is sufficiently charged
- the system does not detect moisture on the windscreen when the air-conditioning system is switched on
- the bonnet is closed
- the driver's door is closed and the driver's seat belt is fastened

If all conditions for automatic engine switch-off are not fulfilled, the  ECO symbol is shown. All the vehicle's systems remain active when the engine is switched off automatically.

The engine can be switched off automatically a maximum of four times (initial stop, then three subsequent stops) in succession. The  ECO symbol is shown on the multifunction display after the engine has been started automatically for the fourth time. When the  ECO symbol is shown on the multifunction display, automatic engine stop is possible again.

Vehicles with manual transmission

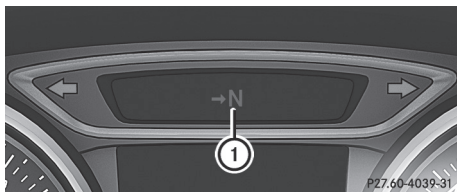

P27.60-4039-31

The ECO start/stop function switches off the engine automatically at low speeds.

- ▶ Brake the vehicle.
- ▶ Shift to neutral **[N]** (▷ page 144) (follow gear-shift instruction ① to shift to neutral **[N]**, as necessary).
- ▶ Release the clutch pedal.
The engine is switched off automatically.

Vehicles with automatic transmission

If the vehicle is braked to a standstill with the transmission in **[D]** or **[N]**, the ECO start/stop function switches off the engine automatically. The HOLD function can be activated if the engine has been switched off automatically. It is then not necessary to continue applying the brakes during the automatic stop phase. When you depress the accelerator pedal, the engine starts automatically and the braking effect of the HOLD function is deactivated.

Automatic engine start

General notes

The engine is started automatically if:

- you switch off the ECO start/stop function by pressing the ECO button **[R]**
- you engage reverse gear **[R]**
- you unfasten your seat belt or open the driver's door
- the vehicle starts to roll
- the brake system requires this
- the temperature in the vehicle interior deviates from the set range
- the system detects moisture on the windscreen when the air-conditioning system is switched on
- the battery's charge status is too low

Vehicles with manual transmission

! Only engage gear when the clutch pedal is depressed.

The engine is started automatically if you:

- depress the clutch pedal fully
- depress the accelerator pedal

Vehicles with automatic transmission

The engine is started automatically if you:

- release the brake pedal in transmission position **[D]** or **[N]** when the HOLD function is not active
- depress the accelerator pedal
- move the transmission out of position **[P]**

Shifting the transmission to position **[P]** does not start the engine.

If you shift the transmission from **[R]** to **[D]**, the ECO start/stop function is available as soon as the **[A]** ECO symbol appears on the multifunction display.

Switching the ECO start/stop function off/on



▶ **To deactivate:** press ECO button ①. Indicator lamp ② and the **[A]** or **[A]** ECO symbol on the multifunction display go out.

▶ **To activate:** press ECO button ①. Indicator lamp ② lights up.

If all conditions for the automatic engine switch-off (▷ page 139) are fulfilled, the **[A]** ECO symbol is shown on the multifunction display.

If all conditions for the automatic engine switch-off (▷ page 139) are not fulfilled, the **[A]** ECO symbol is shown on the multifunction display. If this is the case, the ECO start/stop function is not available.

If indicator lamp ② is off, the ECO start/stop function has been deactivated manually or as the result of a malfunction. The engine will then not be switched off automatically when the vehicle stops.

AMG performance exhaust system (Mercedes-AMG vehicles)

You can choose between different AMG Performance exhaust system volumes using the position of the exhaust flap.

If the ignition has been switched off for less than four hours, the last setting selected remains activated when the engine is next started. If the ignition has been switched off for more than four hours, the quietest setting is activated when the engine is next started.

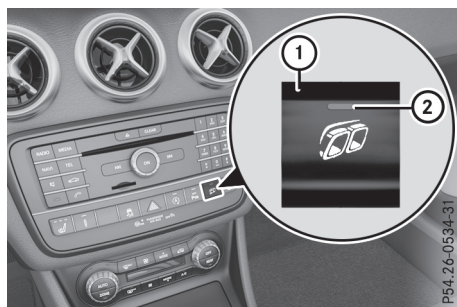

Setting the volume:

- ▶ Press button ①.
- If you select the loudest setting, indicator lamp ② lights up.

Problems with the engine

Problem	Possible causes/consequences and ► Solutions
The engine does not start.	<p>The HOLD function or Distance Pilot DISTRONIC is activated.</p> <ul style="list-style-type: none"> ▶ Deactivate the HOLD function (> page 175) or Distance Pilot DISTRONIC (> page 172). ▶ Try to start the engine again.
The engine does not start. The starter motor can be heard.	<ul style="list-style-type: none"> • The engine electronics are malfunctioning • The fuel supply is malfunctioning <p>Before attempting to restart the engine:</p> <ul style="list-style-type: none"> ▶ Turn the key back to position 0 in the ignition lock. or ▶ Press the Start/Stop button repeatedly until all indicator lamps on the instrument cluster go out. ▶ Try to start the engine again. Avoid excessively long and frequent attempts to start the engine, as this will drain the battery. <p>If the engine does not start after several attempts:</p> <ul style="list-style-type: none"> ▶ Consult a qualified specialist workshop.

Problem	Possible causes/consequences and ► Solutions
<p>The engine does not start. The starter motor can be heard. The reserve fuel warning lamp is lit and the fuel gauge display shows 0.</p>	<p>The fuel tank is empty.</p> <ul style="list-style-type: none"> ► Refuel the vehicle.
<p>The engine does not start. You cannot hear the starter motor.</p>	<p>The on-board voltage is too low because the battery is too weak or discharged.</p> <ul style="list-style-type: none"> ► Jump-start the vehicle (▷ page 307). <p>If the engine does not start despite attempts to jump-start it:</p> <ul style="list-style-type: none"> ► Consult a qualified specialist workshop. <p>The starter motor was exposed to excessively high thermal load.</p> <ul style="list-style-type: none"> ► Allow the starter motor to cool down for approximately two minutes. ► Try to start the engine again. <p>If the engine still does not start:</p> <ul style="list-style-type: none"> ► Consult a qualified specialist workshop.
<p>Vehicles with a petrol engine: The engine is not running smoothly and is misfiring.</p>	<p>The engine electronics or a mechanical component of the engine management system is malfunctioning.</p> <ul style="list-style-type: none"> ► Only depress the accelerator pedal slightly. Otherwise, non-combusted fuel may get into the catalytic converter and damage it. ► Have the cause rectified immediately at a qualified specialist workshop.
<p>The coolant temperature display is showing more than 120 °C. The coolant warning lamp may also be on and a warning tone may sound.</p>	<p>The coolant level is too low. The coolant is too hot and the engine is not being cooled sufficiently.</p> <ul style="list-style-type: none"> ► Stop as soon as possible and allow the engine and the coolant to cool down. ► Check the coolant level (▷ page 288). Observe the warning notes as you do so and top up the coolant if necessary. <p>If the coolant level is correct, the engine radiator fan may be faulty. The coolant is too hot and the engine is not being cooled sufficiently.</p> <ul style="list-style-type: none"> ► If the coolant temperature is below 120 °C, you can continue driving to the nearest qualified specialist workshop. ► Avoid heavy loads on the engine as you do so, e.g. driving in mountainous terrain and stop-start traffic.

DYNAMIC SELECT button (all vehicles except Mercedes-AMG vehicles)

Use the DYNAMIC SELECT button to change the drive program. Depending on the drive program selected, the following vehicle characteristics will change:

- the drive (engine and transmission management)
- the suspension (vehicles with adjustable damping or AMG RIDE CONTROL)
- the sound of the exhaust system (vehicles with sports exhaust system)
- the steering
- the availability of the ECO start/stop function
- the climate control

If the ignition has been switched off for less than four hours, the last drive program selected remains activated when the engine is next started. If the ignition has been switched off for more than four hours, drive program **C** is activated when the engine is next started.



- ▶ Press DYNAMIC SELECT controller ① as many times as necessary until the desired drive program is selected. The drive program selected appears on the multifunction display. After five seconds the display goes out and the status icon of the selected drive program appears.

In addition, the current drive program settings are shown briefly on the multimedia system display.

- i** For a few countries, the ECO start/stop function is deactivated at the factory due to the quality of the available fuel. In this case, the ECO start/stop function is not available in any drive program, regardless of what is shown on the multimedia system display.

Available drive programs:

C Comfort	Comfortable and economical driving characteristics
S Sport	Sporty driving characteristics
I Individual	Personalised settings
E Economy	Particularly economical driving characteristics

Additional information on drive programs (▷ page 150).

You can also shift gears yourself using the steering wheel gearshift paddles. Further information on manual gearshifting (▷ page 152).

DYNAMIC SELECT controller (Mercedes-AMG vehicles)

Use the DYNAMIC SELECT controller to change the drive program. Depending on the drive program selected, the following vehicle characteristics will change:

- the drive
- the transmission management
- ESP®
- the suspension (vehicles with AMG RIDE CONTROL)
- the sound of the exhaust system
- the availability of the ECO start/stop function
- the availability of glide mode

If the ignition has been switched off for less than four hours, the last drive program selected remains active when the engine is next started. If the ignition has been switched off for more than four hours, drive program **C** is activated when the engine is next started.



- ▶ Turn DYNAMIC SELECT controller ① until the desired drive program is selected. The drive program selected appears on the multifunction display. After five seconds, the display goes out and the symbol of the selected drive program appears.

The drive program indicator on DYNAMIC SELECT controller ① lights up in red.

Available drive programs:

I Individual	Personalised settings
C Comfort	Comfort-oriented, engine and transmission settings optimised for economy
S Sport	Sporty engine and transmission settings
S+ Sport Plus	Particularly sporty transmission settings
RACE	Maximum sportiness and engine and transmission settings suitable for the racetrack

Additional information on drive programs (▶ page 150).

You can also shift gears yourself using the steering wheel gearshift paddles. Further information on manual gearshifting (▶ page 152).

Manual transmission

Gear lever

- ! Only engage gear when the clutch pedal is depressed.
- ! If you shift to gears ⑤ and ⑥, you should always move the gear lever all the way to the

right. Otherwise, you could unintentionally shift into gear ③ or ④ and damage the engine or the transmission.

If you shift down at too high a speed (transmission braking), this can cause the engine to overrev, leading to engine damage.

Do not use the clutch bite point to keep the vehicle stationary on uphill gradients. There is otherwise a risk of damaging the clutch.

- ! On long and steep downhill gradients, especially if the vehicle is laden or towing a trailer, you must select gear ①, ② or ③ in good time. By doing so, you will make use of the braking effect of the engine. This relieves the load on the brake system and prevents the brakes from overheating and wearing too quickly.

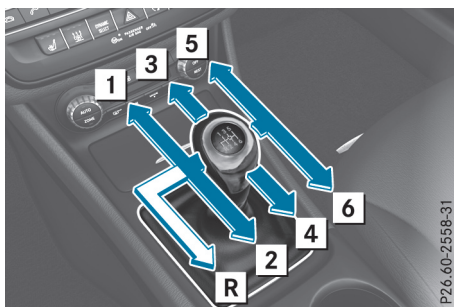

- R Reverse gear
- ① - ⑥ Forward gears

Selecting neutral N



- ▶ Depress the clutch pedal fully.
- ▶ Move the gearshift lever to position N ①.

Engaging reverse gear

! Select reverse gear **R** only when the vehicle is stationary. You could otherwise damage the transmission.

- ▶ Pull the gear lever up, push it to the left and then pull it back.

The ECO start/stop function is not available when reverse gear is engaged. For further information on the ECO start/stop function, see (▷ page 139).

Gearshift recommendation

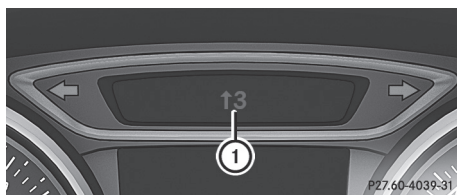

The gearshift recommendation assists you in adopting a fuel-efficient driving style. The recommended gear is shown on the multifunction display.

- ▶ Shift gear according to gearshift recommendation ① when shown in the multifunction display of the instrument cluster.

Drive programs

Drive program C (Comfort)

Drive program **C** is characterised by the following:

- the vehicle exhibits comfortable, economical driving characteristics.
- the vehicle has improved driving stability, e.g. on slippery road surfaces.

Drive program S (Sport)

Drive program **S** is characterised by the following:

- sporty engine settings.

Drive program I (Individual)

In drive program **I**, the following properties of the drive program can be selected:

- the drive (engine and transmission management)
- the suspension (vehicles with adjustable damping or AMG RIDE CONTROL)
- the steering
- the availability of the ECO start/stop function
- the climate control

Information on configuring drive program **I** with the multimedia system can be found in the Digital Owner's Manual.

Drive program E (Economy)

Drive program **E** is characterised by the following:

- the vehicle exhibits particularly economical driving characteristics.
- the vehicle has improved driving stability, e.g. on slippery road surfaces.
- the performance of the air-conditioning and heating systems is reduced.

Automatic transmission

Important safety notes

WARNING

If the engine speed is above the idling speed and you engage transmission position **D** or **R**, the vehicle could pull away suddenly. There is a risk of an accident.

When engaging transmission position **D** or **R**, always firmly depress the brake pedal and do not simultaneously accelerate.

WARNING

The automatic transmission switches to neutral position **N** when you switch off the engine. The vehicle may roll away. There is a risk of an accident.

After switching off the engine, always switch to parking position **P**. Prevent the parked vehicle from rolling away by applying the parking brake.

DIRECT SELECT lever

Overview of transmission positions

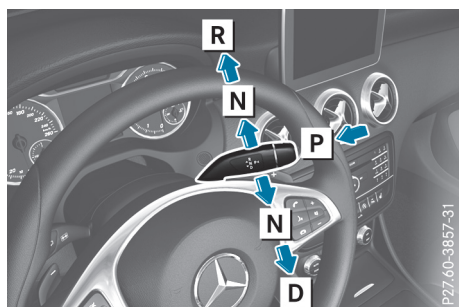

- P** Park position with parking lock
- R** Reverse gear
- N** Neutral
- D** Drive

All vehicles (except Mercedes-AMG vehicles): the DIRECT SELECT lever is on the right of the steering column.

For information on the selector lever in Mercedes-AMG vehicles (▷ page 147).

The DIRECT SELECT lever always returns to its original position. The current transmission position **P**, **R**, **N** or **D** is shown in the transmission position display on the multifunction display (▷ page 146).

Transmission position and drive program display

The current transmission position and drive program appear on the multifunction display.

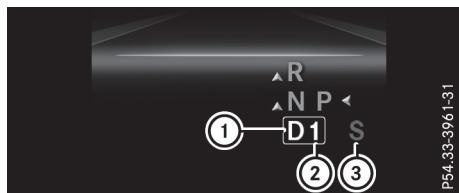

- ① Transmission position display
- ② Gear
- ③ Drive program display

The arrows on the transmission position display show how and into which transmission positions you can shift using the DIRECT SELECT lever.

If the transmission position display on the multifunction display is not working, you should pull

away carefully to check whether the desired transmission position is engaged. Ideally, you should select transmission position **D** and drive program **E** or **S**.

Engaging park position P

! If the engine speed is too high or the vehicle is coasting, do not shift the automatic transmission directly from **D** to **R**, from **R** to **D** or directly to **P**. Otherwise, the automatic transmission may be damaged.

- ▶ Push the DIRECT SELECT lever switch in the direction of arrow **P**. Transmission position display **P** is shown on the multifunction display.

When you have engaged park position **P**, make sure that the transmission position display shows **P** on the multifunction display.

You can engage park position **P** only when the vehicle is stationary; do not switch directly to park position **P** at high engine speed.

Depressing the brake and pushing the DIRECT SELECT lever up or down disengages the parking lock. The transmission is in neutral **N**.

At transmission fluid temperatures below -20°C , you can only shift out of park position **P** into another transmission position when the engine is running.

In order to shift from park position **P** directly into **R** or **D**:

- depress the brake pedal and
- push the DIRECT SELECT lever up or down past the first point of resistance

Engaging park position P automatically

Park position **P** is automatically engaged if:

- you switch off the engine using the key and remove the key
- you switch off the engine using the key or using the Start/Stop button and open the driver's door or front-passenger door
- you open the driver's door when the vehicle is stationary or when driving at a very low speed and the transmission is in position **D** or **R**

In certain situations, the automatic transmission shifts automatically to transmission position **P** if the HOLD function or Distance Pilot DISTRONIC is activated. Observe the information on the HOLD function (▷ page 175) and on Distance Pilot DISTRONIC (▷ page 171).

Engaging reverse gear R

I Only move the automatic transmission to **R** when the vehicle is stationary.

- ▶ Depress the brake pedal and keep it depressed.
- ▶ Push the DIRECT SELECT lever up past the first point of resistance.

The ECO start/stop function is not available when reverse gear is engaged. For further information on the ECO start/stop function, see (▷ page 139).

Selecting neutral N

WARNING

If children are left unsupervised in the vehicle, they could:

- operate vehicle equipment and become trapped, for example

In addition, the children could also set the vehicle in motion, for example, if they:

- release the parking brake
- shift the automatic transmission out of park position **P**
- start the engine.

There is a risk of an accident and injury.

Never leave children and animals unattended in the vehicle.

When leaving the vehicle, always take the key with you and lock the vehicle. This also applies to mobile phones if the "Digital Car Key in smartphone" function is activated via the Mercedes me connect web app.

- ▶ If the transmission is in position **D** or **R**: push the DIRECT SELECT lever up or down to the first point of resistance.
- ▶ If the transmission is in position **P**: depress the brake pedal and push the DIRECT SELECT lever up or down to the first point of resistance.

If you switch the engine off with the transmission in position **R** or **D**, the automatic transmission shifts to **N** automatically.

With the key: if you then open the driver's door or the front-passenger door or remove the key

from the ignition, the automatic transmission shifts to **P** automatically.

With the Start/Stop button: if you then open the driver's door or the front-passenger door, the automatic transmission shifts to **P** automatically.

If you want the automatic transmission to remain in neutral **N**, e.g. when having the vehicle cleaned in an automatic car wash with a towing system:

- ▶ **Vehicles with the Start-Stop button:** remove the Start-Stop button from the ignition lock.
- ▶ Insert the key into the ignition lock.
- ▶ **All vehicles:** switch the ignition on.
- ▶ Depress the brake pedal and keep it depressed.
- ▶ Engage neutral **N**.
- ▶ Release the brake pedal.
- ▶ Release the electric parking brake.
- ▶ Switch off the ignition and leave the key in the ignition lock.

Engaging drive position D

- ▶ If the transmission is in position **R** or **N**: push the DIRECT SELECT lever down past the first point of resistance.
- ▶ If the transmission is in position **P**: depress the brake pedal and push the DIRECT SELECT lever down past the first point of resistance.

Selector lever (Mercedes-AMG vehicles)

Overview of transmission positions

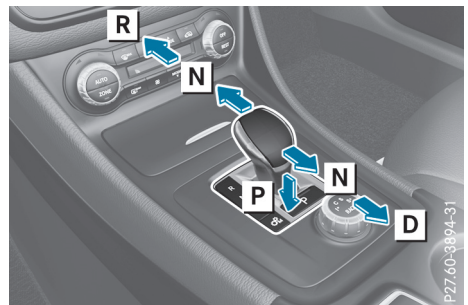

- P** Park position with parking lock
- R** Reverse gear

- N** Neutral
- D** Drive

Transmission position and drive program display

The current transmission position and drive program appear on the multifunction display.

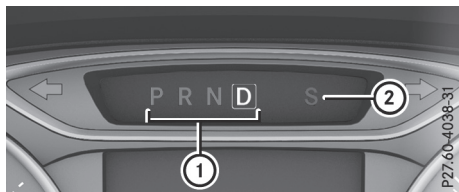

- ① Transmission position display
- ② Drive program display

If the transmission position display on the multifunction display is not working, you should pull away carefully to check whether the desired transmission position is engaged. Ideally, you should select transmission position **D** and drive program **C** or **S**.

Engaging park position P

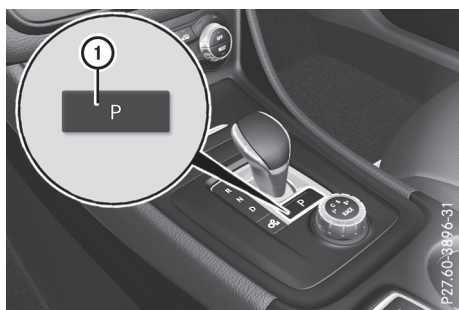

- ▶ When the vehicle is stationary, press button ①.

Engaging reverse gear R

- ❗ Only move the automatic transmission to **R** when the vehicle is stationary.
- ▶ Depress the brake pedal and keep it depressed.
- ▶ Push the selector lever forwards past the first point of resistance.

Transmission positions

P Park position

This safeguards the vehicle against rolling away when stopped.

Only shift the transmission to position **P** when the vehicle is stationary. The parking lock should not be used as a brake when parking. In order to secure the vehicle, always apply the electric parking brake in addition to the parking lock.

In the event of a malfunction of the vehicle's electronics, the transmission may lock in position **P**. Have the vehicle electronics checked immediately at a qualified specialist workshop.

Park position **P** is automatically engaged if:

- you switch off the engine using the key and remove the key
- you switch off the engine using the key or using the Start/Stop button and open the driver's door or front-passenger door
- you open the driver's door when the vehicle is stationary or when driving at a very low speed and the transmission is in position **D** or **R**

R Reverse gear

Only shift the transmission into position **R** when the vehicle is stationary.

N**Neutral**

Do not shift the transmission to **N** while driving. The automatic transmission could otherwise be damaged.

No power is transmitted from the engine to the drive wheels.

Releasing the brakes will allow you to move the vehicle freely, e.g. to push it or tow it.

If ESP® is deactivated or faulty: shift the transmission to position **N** if the vehicle is in danger of skidding, e.g. on icy roads.

If you switch the engine off with the transmission in position **R** or **D**, the automatic transmission shifts to **N** automatically.

! Coasting in neutral **N** may cause damage to the drive train.

D**Drive**

The automatic transmission changes gear automatically. All forward gears are available.

Driving tips**Changing gear**

The automatic transmission shifts through the individual gears automatically when it is in transmission position **D**. This is determined by:

- the drive program selected
- the position of the accelerator pedal
- the road speed

Accelerator pedal position

Your driving style influences how the automatic transmission shifts gear:

- little throttle: early upshifts
- more throttle: late upshifts

Holding the vehicle stationary on uphill gradients**⚠ WARNING**

If the clutch overheats, the electronic management system is automatically deactivated. This interrupts the power transmission. The vehicle may, for example, roll backwards on gradients. There is a risk of an accident.

Never hold the vehicle stationary on uphill gradients by depressing the accelerator.

The clutch may overheat if you hold the vehicle stationary on uphill gradients by depressing the accelerator pedal. If the clutch overheats, a warning tone sounds.

All vehicles (except Mercedes-AMG vehicles): the **Stop vehicle Shift to P Leave engine running** display message appears on the multifunction display. You will only be able to continue your journey once the clutch has cooled down and the display message on the multifunction display has disappeared.

Mercedes-AMG vehicles: the **Trans. oil overheated Drive on with care** display message appears on the multifunction display.

Do not hold the vehicle stationary on uphill gradients by depressing the accelerator pedal. Instead, only ever hold the vehicle stationary on uphill gradients by:

- depressing the brake pedal
- activating the HOLD function
- applying the electric parking brake

Kickdown

Use kickdown for maximum acceleration:

- ▶ Depress the accelerator pedal beyond the pressure point.
The automatic transmission shifts to a lower gear depending on the engine speed.
- ▶ Ease off the accelerator pedal once the desired speed is reached.
The automatic transmission shifts back up.

Mercedes-AMG vehicles: it is only possible to use kickdown in the automatic drive programs and in temporary manual drive program **M**. When manual drive program **M** is selected permanently, kickdown is not possible.

For further information on kickdown in manual drive program **M** (> page 154).

Glide mode (diesel engines only)

Glide mode is characterised by the following:

- the combustion engine is disconnected from the drive train
- the engine is running at idling speed
- the gear indicated after the transmission position **D** disappears from the multifunction display (> page 148)

Gliding mode can be activated and transmission position **D** shown in green under the following conditions:

- you select the "ECO" setting for the drive system within the **Individual** drive program. You can find information about this in the Digital Owner's Manual
- the speed is within a suitable range
- the type of road is suitable, e.g. no steep uphill or downhill gradients
- the distance to the vehicle in front is sufficient
- you are no longer depressing the accelerator pedal

Glide mode is deactivated under the following conditions:

- you depress the accelerator pedal
- you depress the brake pedal
- you use the DIRECT SELECT lever to switch the transmission position (> page 146)
- you use the DYNAMIC SELECT controller to change the drive program (> page 143)
- you activate manual gearshifting (> page 152)
- the distance to the vehicle in front is too short
- you leave the suitable speed range

Towing a trailer

Not all models can tow a trailer. For further information, see (> page 197).

- ▶ Drive in the middle of the engine speed range on uphill gradients.
- ▶ Depending on the uphill or downhill gradient, select a lower gear (> page 162), even if cruise control, Distance Pilot DISTRONIC or the speed limiter are activated.

Drive programs

All vehicles (except Mercedes-AMG vehicles)

Drive program C (Comfort)

Drive program **C** is characterised by the following:

- the vehicle exhibits comfortable, economical driving characteristics.
- the vehicle pulls away more gently in forward and reverse gears unless the accelerator pedal is depressed fully.
- the vehicle has improved driving stability, e.g. on slippery road surfaces.
- optimal fuel consumption resulting from the automatic transmission shifting up sooner. The vehicle is driven in the low engine speed range and the wheels are less likely to spin.

Drive program S (Sport)

Drive program **S** is characterised by the following:

- sporty engine settings.
- the automatic transmission shifts up later. Fuel consumption may be higher as a result of the later automatic transmission shift points.

Drive program I (Individual)

In drive program **I**, the following properties of the drive program can be selected:

- the drive (engine and transmission management)
- the suspension (vehicles with adjustable damping or AMG RIDE CONTROL)
- the steering
- the availability of the ECO start/stop function
- the climate control

Information on configuring drive program **I** with the multimedia system can be found in the Digital Owner's Manual.

- i** To permanently shift the gears manually in drive program **I** using the steering wheel gear-shift paddles, select the **M** (Manual) setting for the drive.

Drive program E (Economy)

Drive program **E** is characterised by the following:

- comfort-oriented engine settings.
- optimal fuel consumption resulting from the automatic transmission shifting up sooner.
- the vehicle pulls away more gently in forward and reverse gears unless the accelerator pedal is depressed fully.
- the vehicle has improved driving stability, e.g. on slippery road surfaces.
- the automatic transmission shifts up sooner. This results in the vehicle being driven at lower engine speeds and the wheels being less likely to spin.
- gliding mode is activated automatically when engine-internal conditions are fulfilled and the accelerator is not depressed. At the same time the transmission's clutch opens and the vehicle rolls freely using its kinetic energy. As a result great distances can be completed without the engine brake and fuel consumption reduced.

i The availability of gliding mode depends on various factors, including the following:

- the engine and transmission temperature
- the downhill gradient
- the vehicle speed
- performing regular adaptation functions

When you depress the brake pedal, gliding mode is deactivated, depending on pedal pressure.

When you activate cruise control or Distance Pilot DISTRONIC, gliding mode is not available.

Mercedes-AMG vehicles

Drive program I (Individual)

In drive program **I**, the following properties of the drive program can be selected:

- the drive (engine management)
- the transmission management
- the suspension (vehicles with AMG RIDE CONTROL)
- ESP®

Information on configuring drive program **I** with the multimedia system can be found in the Digital Owner's Manual.

Drive program C (Comfort)

Drive program **C** is characterised by the following:

- the vehicle exhibits comfortable, economical driving characteristics.
- the vehicle pulls away more gently in forward and reverse gears unless the accelerator pedal is depressed fully.
- the vehicle has improved driving stability, e.g. on slippery road surfaces.
- optimal fuel consumption resulting from the automatic transmission shifting up sooner. The vehicle is driven in the low engine speed range and the wheels are less likely to spin.
- gliding mode is available.
- the ECO start/stop function is available.

Drive program S (Sport)

Drive program **S** is characterised by the following:

- the vehicle exhibits sporty driving characteristics.
- the automatic transmission shifts up later. Fuel consumption may be higher as a result of the later automatic transmission shift points.
- the suspension exhibits stiff springing and damping settings (vehicles with AIR RIDE CONTROL).
- gliding mode is not available.
- the ECO start/stop function is not available.

Drive program S+ (Sport Plus)

Drive program **S+** is characterised by the following:

- the vehicle exhibits particularly sporty driving characteristics.
- the automatic transmission shifts up later.
- fuel consumption may be higher as a result of the later automatic transmission shift points.
- the suspension exhibits particularly stiff springing and damping settings (vehicles with AIR RIDE CONTROL).
- gliding mode is not available.
- the ECO start/stop function is not available.

Drive program RACE (vehicles with AMG RIDE CONTROL)

Drive program **RACE** is characterised by the following:

- the vehicle exhibits driving characteristics suitable for the racetrack.
- all vehicle systems are set for maximum sportiness.
- the automatic transmission shifts up later.
- fuel consumption may be higher as a result of the later automatic transmission shift points.
- the suspension exhibits particularly rigid springing and damping settings.
- gliding mode is not available.
- the ECO start/stop function is not available.

Manual gearshifting

General notes

You can shift gears yourself using the steering wheel gearshift paddles. The transmission must be in position **D** to do this.

Depending on which steering wheel gearshift paddle is pulled, the automatic transmission immediately shifts into the next gear up or down, if permitted.

Mercedes-AMG vehicles: to use manual gearshifting, you have two options:

- temporary setting
- permanent setting

If you activate manual gearshifting, the multi-function display will show the current gear instead of transmission position **D**.

If manual gearshifting is deactivated, the gears will be selected automatically.

Temporary setting

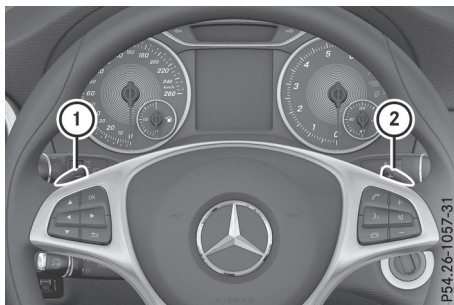

- ▶ **To activate:** shift the DIRECT SELECT lever to position **D**.
- ▶ Pull steering wheel gearshift paddle ① or ②.

The temporary setting will remain active for a certain amount of time. Under certain conditions, the minimum amount of time is extended, e.g. in the case of lateral acceleration, during an overrun phase or when driving on steep terrain.

- ▶ **To deactivate:** pull steering wheel gearshift paddle ② and hold it in place.

or

- ▶ Use the DIRECT SELECT lever to shift the transmission position.

or

- ▶ All vehicles (except Mercedes-AMG vehicles): use the DYNAMIC SELECT button to change the drive program.

Mercedes-AMG vehicles: use the DYNAMIC SELECT controller to change the drive program.

Permanent setting (Mercedes-AMG vehicles)

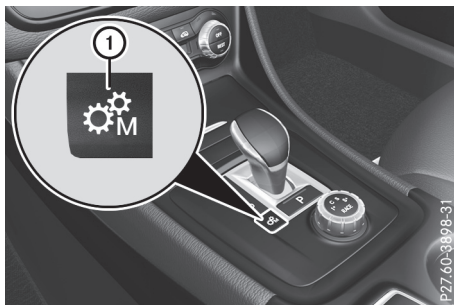

- ▶ **To activate:** shift the selector lever to **D**.
- ▶ Press the **1** button.

- ▶ **To deactivate:** press button **1**.

or

- ▶ If position **D** (automatic transmission) is selected for the transmission in drive program **I**: shift to drive program **I** with the DYNAMIC SELECT controller.

Shifting gears

- ▶ **Mercedes-AMG vehicles:** the automatic transmission does not shift up automatically even when the engine limiting speed for the current gear is reached. When the engine limiting speed is reached, the fuel supply is cut to prevent the engine from overrevving. Always make sure that the engine speed does not reach the red area of the rev counter. There is otherwise a risk of engine damage.

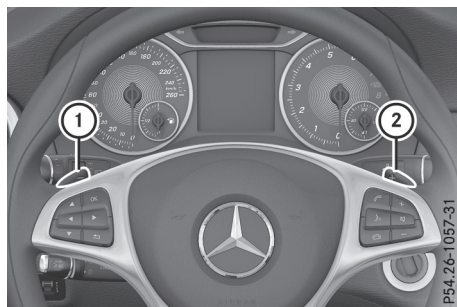

- ▶ **To shift up:** pull steering wheel gearshift paddle **2**.

The automatic transmission shifts up to the next gear.

All vehicles (except Mercedes-AMG vehicles): if the maximum engine speed in the currently engaged gear is reached and you continue to accelerate, the automatic transmission automatically shifts up in order to prevent engine damage.

- ▶ **To shift down:** pull steering wheel gearshift paddle **1**.

The automatic transmission shifts down to the next gear.

Automatic downshifting occurs when coasting.

If the engine were to exceed the maximum engine speed when shifting down, the auto-

matic transmission protects against engine damage by not shifting down.

Gearshift recommendation

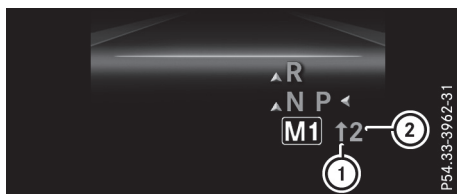

The gearshift recommendation assists you in adopting a fuel-efficient driving style. The recommended gear is shown on the multifunction display.

- ▶ Shift to recommended gear **2** according to gearshift recommendation **1** when shown in the multifunction display.

Upshifting (Mercedes-AMG vehicles)

- ▶ **In manual mode,** the automatic transmission does not shift up automatically even when the engine limiting speed for the current gear is reached. When the engine limiting speed is reached, the fuel supply is cut to prevent the engine from overrevving. Always make sure that the engine speed does not reach the red area of the rev counter. There is otherwise a risk of engine damage.

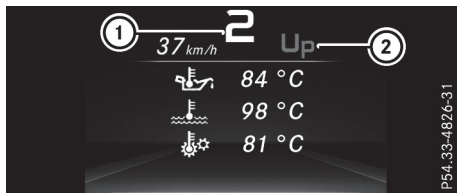

Before the engine speed reaches the red area, an upshift indicator will be shown on the multifunction display.

- ▶ Shift to recommended gear **1** when message **2** is shown in the multifunction display.

Kickdown

- ▶ For maximum acceleration, depress the accelerator pedal beyond the pressure point. The automatic transmission shifts to a lower gear depending on the engine speed.
- ▶ Shift back up once the desired speed is reached.

During kickdown, you cannot shift gears using the steering wheel gearshift paddles.

If you apply full throttle, the automatic transmission shifts up to the next gear when the maximum engine speed is reached. This prevents the engine from overrevving.

Mercedes-AMG vehicles: it is only possible to use kickdown in temporary manual drive program **M**. When manual drive program **M** is selected permanently, kickdown is not possible.

Problems with the transmission

Problem	Possible causes/consequences and ▶ Solutions
The transmission has problems shifting gear.	The transmission is losing oil. ▶ Have the transmission checked at a qualified specialist workshop immediately.
The acceleration ability is deteriorating. The transmission no longer shifts into all of the gears. Reverse gear can no longer be engaged.	The transmission is in emergency mode. ▶ Stop. ▶ Shift the transmission to position P . ▶ Switch off the engine. ▶ Wait at least ten seconds before restarting the engine. ▶ Shift the transmission to position D . ▶ Have the transmission checked at a qualified specialist workshop immediately.

Refuelling

Important safety notes

WARNING

Fuel is highly flammable. If you handle fuel incorrectly, there is a risk of fire and explosion.

You must avoid fire, naked flames, creating sparks and smoking. Switch off the engine and, if applicable, the auxiliary heating before refuelling.

WARNING

Fuels are poisonous and hazardous to health. There is a danger of injury.

Do not swallow fuel or let it come into contact with skin, eyes or clothing. Do not inhale fuel

vapours. Keep fuels out of the reach of children.

If you or others come into contact with fuel, observe the following:

- Wash the fuel off any affected areas of skin with water and soap immediately.
- If you get fuel in your eyes, rinse them thoroughly with clean water immediately. Seek immediate medical attention.
- If fuel is swallowed, seek immediate medical attention. Do not induce vomiting.
- Change any clothing that has come into contact with fuel immediately.

WARNING

Electrostatic charge can cause sparks and thereby ignite fuel vapours. There is a risk of fire and explosion.

Always touch the vehicle body before opening the fuel filler flap or touching the fuel pump nozzle. This discharges any electrostatic charge that may have built up.

WARNING

Vehicles with a diesel engine:

If you mix diesel fuel with petrol, the flash point of this fuel mixture is lower than that of pure diesel fuel. When the engine is running, components in the exhaust system may over-heat unnoticed. There is a risk of fire.

Never refuel with petrol. Never add petrol to diesel fuel.

! Do not use diesel to refuel vehicles with a petrol engine. Do not switch on the ignition if you accidentally refuel with the wrong fuel. Otherwise, the fuel will enter the fuel system. Even small amounts of the wrong fuel can result in damage to the fuel system and the engine. Notify a qualified specialist workshop and have the fuel tank and fuel lines drained completely.

! Do not use petrol to refuel vehicles with a diesel engine. Do not switch on the ignition if you accidentally refuel with the wrong fuel. Otherwise, fuel can enter the fuel system. Even small amounts of the wrong fuel could result in damage to the fuel system and the engine. The repair costs are high. Notify a qualified specialist workshop and have the fuel tank and fuel lines drained completely.

! Overfilling the fuel tank could damage the fuel system.

! Take care not to spill any fuel on painted surfaces. You could otherwise damage the paintwork.

! Use a filter when adding fuel from a fuel can. The fuel lines and/or the fuel injection system could otherwise be blocked by particles from the fuel can.

Do not get back into the vehicle during the refuelling process; Otherwise, electrostatic charge could build up again.

If you overfill the fuel tank, some fuel may spray out when you remove the fuel pump nozzle.

Further information on fuel and fuel quality (▷ page 334).

Refuelling

General information

Observe the important safety notes (▷ page 154).

The fuel filler flap is unlocked/locked automatically when you unlock/lock the vehicle with the key.

The position of the fuel filler cap is displayed  on the instrument cluster. The arrow next to the filling pump indicates the side of the vehicle.

Opening the fuel filler flap

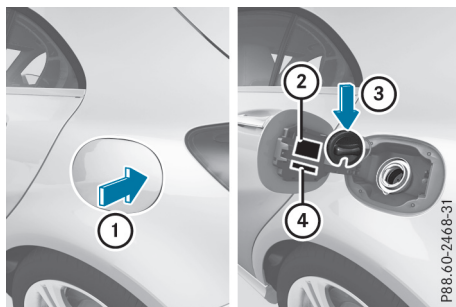

- ① Opening the fuel filler flap
- ② Tyre pressure table
- ③ Insert the fuel filler cap
- ④ Instruction label indicating the fuel type to be refuelled

- ▶ Switch off the engine.
- ▶ Remove the key from the ignition lock.

Or, on vehicles with KEYLESS-GO start function or KEYLESS-GO:

- ▶ Open the driver's door. The vehicle electronics are now in position . This is the same as the key having been removed.
- ▶ Press the fuel filler flap in the direction of arrow ①. The fuel filler flap swings open.
- ▶ Turn the fuel filler cap anti-clockwise and remove it.
- ▶ Insert the fuel filler cap into the holder on the inside of fuel filler flap ③.

- ▶ Completely insert the filler neck of the fuel pump nozzle into the tank, hook in place and refuel.
- ▶ Fill the tank only until the pump nozzle switches off.

i Do not add any more fuel after the pump stops filling for the first time. Otherwise, fuel may leak out.

i **Vehicles with a diesel engine:** the filler neck is designed for refuelling at diesel filling pumps.

i **Vehicles with a diesel engine:** if the fuel tank has been run completely dry, refuel the vehicle with at least 5 l of diesel.

i **Vehicles with a diesel engine:** when refuelling from a can, use a filler neck with a large diameter for diesel vehicles.

Otherwise, the filler neck cannot be fitted into the tank opening.

Closing the fuel filler flap

- ▶ Replace the cap on the filler neck and turn clockwise until it engages audibly.
- ▶ Close the fuel filler flap.

Close the fuel filler flap before locking the vehicle.

Problems with the fuel and fuel tank

Problem	Possible causes/consequences and ▶ Solutions
Fuel is leaking from the vehicle.	<p>The fuel line or the fuel tank is faulty.</p> <p> WARNING</p> <p>There is a risk of fire or explosion.</p> <ul style="list-style-type: none"> ▶ Apply the electric parking brake. ▶ Switch off the engine. ▶ Remove the key from the ignition lock. <p>or, on vehicles with KEYLESS-GO start function or KEYLESS-GO:</p> <ul style="list-style-type: none"> ▶ Open the driver's door. <p>The vehicle electronics are now in position 0. This is the same as "key removed".</p> <ul style="list-style-type: none"> ▶ Do not restart the engine under any circumstances. ▶ Consult a qualified specialist workshop.
The engine does not start.	<p>The fuel tank of a vehicle with a diesel engine has been run completely dry.</p> <ul style="list-style-type: none"> ▶ Refuel the vehicle with at least 5 l of diesel. ▶ Turn the ignition on for approximately ten seconds (▷ page 135). ▶ Start the engine continuously for a maximum of ten seconds until it runs smoothly. <p>If the engine does not start:</p> <ul style="list-style-type: none"> ▶ Turn the ignition on again for a maximum of ten seconds (▷ page 135). ▶ Start the engine again continuously for a maximum of ten seconds until it runs smoothly. <p>If the engine does not start after three attempts:</p> <ul style="list-style-type: none"> ▶ Consult a qualified specialist workshop.

Problem	Possible causes/consequences and ► Solutions
The fuel filler flap cannot be opened.	The fuel filler flap is not unlocked. ► Unlock the vehicle (▷ page 77).
	The key battery is weak or discharged. ► Unlock the vehicle using the emergency key element (▷ page 85).
	The fuel filler flap is unlocked, but the opening mechanism is jammed. ► Consult a qualified specialist workshop.

Parking

Important safety notes

WARNING

Flammable material such as leaves, grass or twigs may ignite if they come into contact with hot parts of the exhaust system or exhaust gas flow. There is a risk of fire.

Park the vehicle so that no flammable material can come into contact with hot vehicle components. In particular, do not park on dry grassland or harvested grain fields.

WARNING

If you leave children unattended in the vehicle, they may be able to set the vehicle in motion if, for example, they:

- release the parking brake
- shift the automatic transmission out of park position **P** or shift manual transmission into neutral
- start the engine

In addition, they may operate vehicle equipment and become trapped. There is a risk of an accident and injury.

When leaving the vehicle, always take the key with you and lock the vehicle. Never leave children unattended in the vehicle.

- ! Always secure the vehicle correctly against rolling away. Otherwise, the vehicle or its drivetrain could be damaged.

To ensure that the vehicle is safeguarded against rolling away unintentionally:

- the electric parking brake must be applied
- on vehicles with manual transmission, engage first gear or reverse gear
- on vehicles with automatic transmission, the transmission must be in position **P** and the transmission position display must show **P** in the multifunction display
- the key must be removed from the ignition lock
- on uphill or downhill gradients, the front wheels must be turned towards the kerb

Switching off the engine

Important safety notes

WARNING

The automatic transmission switches to neutral position **N** when you switch off the engine. The vehicle may roll away. There is a risk of an accident.

After switching off the engine, always switch to parking position **P**. Prevent the parked vehicle from rolling away by applying the parking brake.

Manual transmission

- Shift to either first gear or reverse gear **R**.
- **With the key:** turn the key to position **0** in the ignition lock and remove it. The immobiliser is activated.

- ▶ **With the Start/Stop button:** press the Start/Stop button (▷ page 135). The engine stops and all the indicator lamps on the instrument cluster go out.

If the driver's door is closed, this is the same as key position **1**. If the driver's door is open, this is the same as key position **0**, i.e. the key having been removed.

- ▶ Apply the electric parking brake.

Automatic transmission

- ▶ Apply the electric parking brake.
- ▶ **All vehicles (except Mercedes-AMG vehicles):** shift the transmission to position **P**.



- ▶ **Mercedes-AMG vehicles:** press button **1**.
- ▶ **With the key:** turn the key to position **0** in the ignition lock and remove it. The immobiliser is activated.
- ▶ **With the Start/Stop button:** press the Start/Stop button (▷ page 135). The engine stops and all the indicator lamps on the instrument cluster go out. If the driver's door is closed, this is the same as key position **1**. If the driver's door is open, this is the same as key position **0**, i.e. the key having been removed.

If you switch the engine off with the transmission in position **R** or **D**, the automatic transmission shifts to **N** automatically.

With the key: if you then open the driver's door or the front-passenger door or remove the key from the ignition, the automatic transmission shifts to **P** automatically.

With the Start/Stop button: if you then open the driver's door or the front-passenger door, the automatic transmission shifts to **P** automatically.

If you want the automatic transmission to remain in neutral **N**, e.g. when having the vehicle cleaned in an automatic car wash with a towing system:

- ▶ **Vehicles with the Start-Stop button:** remove the Start-Stop button from the ignition lock.
- ▶ Insert the key into the ignition lock.
- ▶ **All vehicles:** switch the ignition on.
- ▶ Depress the brake pedal and keep it depressed.
- ▶ Engage neutral **N**.
- ▶ Release the brake pedal.
- ▶ Release the electric parking brake.
- ▶ Switch off the ignition and leave the key in the ignition lock.

Electric parking brake

General notes

WARNING

If you leave children unattended in the vehicle, they may be able to set the vehicle in motion if, for example, they:

- release the parking brake
- shift the automatic transmission out of park position **P** or shift manual transmission into neutral
- start the engine

In addition, they may operate vehicle equipment and become trapped. There is a risk of an accident and injury.

When leaving the vehicle, always take the key with you and lock the vehicle. Never leave children unattended in the vehicle.

The function of the electric parking brake is dependent on the on-board voltage. If the on-board voltage is low or the system is malfunctioning, it may not be possible to apply the released parking brake.

- ▶ If this is the case, park the vehicle only on level ground and secure it to prevent it from rolling away.
- ▶ **Vehicles with automatic transmission:** shift the transmission to position **P**.
- ▶ **Vehicles with manual transmission:** engage first gear.

It may not be possible to release an applied parking brake if the on-board voltage is low or if there is a malfunction in the system. Contact a qualified specialist workshop.

The electric parking brake carries out a function check at regular intervals when the engine is switched off. Noises that occur are normal.

Applying or releasing manually

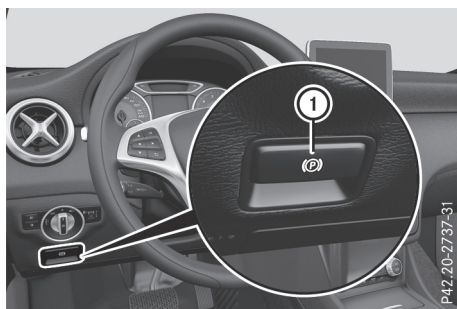

- ▶ **To apply:** push handle ①.
When the electric parking brake is applied, the red **(P)** indicator lamp lights up in the instrument cluster.
The electric parking brake can also be applied when the key is removed.
- ▶ **To release:** pull handle ①.
The red **(P)** indicator lamp on the instrument cluster goes out.
The electric parking brake can be released only:
 - if the key is in position **1** or **2** in the ignition lock (▷ page 135) or
 - if the ignition was switched on using the Start/Stop button

Applying automatically (vehicles with automatic transmission)

The electric parking brake is automatically applied when the transmission is in position **P** and

- the engine is switched off or
- the driver is not wearing a seat belt and the driver's door is opened

To prevent the electric parking brake from being applied automatically, pull handle ①.

The electric parking brake is also applied automatically if:

- Distance Pilot DISTRONIC brings the vehicle to a standstill or
 - the HOLD function is keeping the vehicle stationary or
 - Parking Pilot is keeping the vehicle stationary
- In addition, at least one of the following conditions must be fulfilled:
- the engine is switched off
 - the driver is not wearing a seat belt and the driver's door is opened
 - there is a system malfunction
 - the power supply is insufficient
 - the vehicle is stationary for a lengthy period
- The red **(P)** indicator lamp on the instrument cluster lights up.
- The electric parking brake is not automatically applied if the engine is switched off by the ECO start/stop function.

Applying automatically (vehicles with manual transmission)

The electric parking brake is applied automatically when the vehicle is being kept stationary by the HOLD function.

In addition, at least one of the following conditions must be fulfilled:

- the engine is switched off
- the driver is not wearing a seat belt and the driver's door is open
- there is a system malfunction
- the power supply is insufficient
- the vehicle is stationary for a lengthy period

The red **(P)** indicator lamp on the instrument cluster lights up.

The electric parking brake is not automatically applied if the engine is switched off by the ECO start/stop function.

Releasing automatically

The electric parking brake can only be released automatically in vehicles with automatic transmission.

The electric parking brake of your vehicle is released automatically when all the following conditions are fulfilled:

- the engine is running
- the transmission is in position **D** or **R** and you depress the accelerator pedal or shift from position **P** to **D** or **R**
- the seat belt is fastened

If the transmission is in position **R**, the tailgate must be closed.

If your seat belt is not fastened, the following conditions must be fulfilled for the electric parking brake to be released automatically:

- the driver's door is closed
- you are shifting from transmission position **P** or have previously driven at speeds greater than 3 km/h

Ensure that you do not depress the accelerator pedal unintentionally. Otherwise, the parking brake will be released and the vehicle will start to move.

Emergency braking

The vehicle can also be braked during an emergency by using the electric parking brake.

- ▶ While the vehicle is in motion, push handle ① of the electric parking brake (▷ page 159). The vehicle is braked as long as you keep handle ① of the electric parking brake pressed. The longer the electric parking brake handle ① is depressed, the greater the braking force.

During braking:

- a warning tone sounds
- the **Release parking brake** message appears
- the red  indicator lamp on the instrument cluster flashes

When the vehicle has been braked to a standstill, the electric parking brake is applied.

Parking up the vehicle

If you leave the vehicle parked up for longer than four weeks, the battery may be damaged by exhaustive discharging.

If you leave the vehicle parked up for longer than six weeks, it may suffer from lack of use.

- ▶ Contact a qualified specialist workshop and seek advice.

i You can obtain information on trickle chargers from a qualified specialist workshop.

Driving tips

General notes

Important safety notes

WARNING

If you switch off the ignition while driving, safety-relevant functions are only available with limitations, or not at all. This could affect, for example, the power steering and the brake boosting effect. You will require considerably more effort to steer and brake. There is a risk of an accident.

Do not switch off the ignition while driving.

Drive sensibly – save fuel

Observe the following tips to save fuel:

- The tyres should always be inflated to the recommended tyre pressure.
- Remove unnecessary loads.
- Remove roof racks when they are not needed.
- Warm up the engine at low engine speeds.
- Avoid frequent acceleration or braking.
- Have all maintenance work carried out as indicated by the service intervals in the Service Booklet or by the service interval display.

Fuel consumption also increases when driving in cold weather, in stop-start traffic, on short journeys and in hilly terrain.

ECO display

The ECO display shows you how economical your driving style is. The ECO display assists you

in achieving the most economical driving style for the selected settings and prevailing conditions. Consumption can be significantly influenced by your driving style.



- ① Acceleration
- ② Coasting
- ③ Constant
- ④ Additional range achieved

Range ④ is shown under **Bonus from start** and represents the additional range achieved since the beginning of the journey as a result of an adapted driving style.

If the fuel level has dropped into the reserve range, the **Reserve fuel level** message is shown in the multifunction display instead of range ④. In addition, the  warning lamp in the instrument cluster lights up (> page 256).

The ECO display consists of three sections, with an inner and outer area. The sections correspond to the following three categories:

①	<p>Acceleration (evaluation of the acceleration processes):</p> <ul style="list-style-type: none"> • the outer area fills up and the inner area lights up green: moderate acceleration, especially at higher speeds • the outer area empties and the inner area is grey: sporty acceleration
②	<p>Coasting (evaluation of all deceleration processes):</p> <ul style="list-style-type: none"> • the outer area fills up and the inner area lights up green: anticipatory driving, keeping your distance and early release of the accelerator. The vehicle can coast without use of the brakes. • the outer area empties and the inner area is grey: frequent heavy braking
③	<p>Constant (continuous evaluation over the entire journey):</p> <ul style="list-style-type: none"> • the outer area fills up and the inner area lights up green: constant speed and avoidance of unnecessary acceleration and deceleration • the outer area empties and the inner area is grey: fluctuations in speed

The three inner areas display the current driving style and light up green as a result of a particularly economical driving style. Depending on the driving situation, up to two areas may light up simultaneously.

At the beginning of the journey, the three outer areas are empty and fill up as a result of economical driving. A higher level indicates a more economical driving style. If the three outer areas are completely filled at the same time, the driver has adopted the most economical driving style for the selected settings and prevailing conditions. The ECO display border lights up.

The ECO display does not indicate the actual fuel consumption. The additionally achieved range displayed under **Bonus from start** does not indicate a fixed consumption reduction.

In addition to driving style, the actual consumption is affected by other factors, such as:

- load
- tyre pressure
- cold start
- choice of route
- the use of electrical consumers

These factors are not included in the ECO display.

An economical driving style involves driving at a moderate engine speed.

To achieve a higher value in the categories "Acceleration" and "Constant":

- observe the gearshift recommendation.
- drive the vehicle in drive program **C** or **E** (vehicles with DYNAMIC SELECT button).

On long journeys at a constant speed, e.g. on the motorway, only the outer area for "Constant" will change.

The ECO display summarises the driving style from the start of the journey to its completion. Therefore, there are more marked changes in the outer areas at the start of a journey. During a prolonged driving time, these changes are smaller. For more marked changes, perform a manual reset (▷ page 206).

Further information on the ECO display (▷ page 205).

Brakes

Important safety notes

WARNING

If you shift down on a slippery road surface in an attempt to increase the engine's braking effect, the drive wheels could lose their grip. This increases the risk of skidding and having an accident.

Do not shift down for additional engine braking on a slippery road surface.

Downhill gradients

Shift to a lower gear in good time on long and steep downhill gradients. For vehicles with automatic transmission, you need to activate manual gearshifting beforehand (▷ page 152). Take par-

ticular note of this when driving a laden vehicle and when towing a trailer.

This also applies if you have activated cruise control, the speed limiter or Distance Pilot DISTRONIC.

This will use the braking effect of the engine, so less braking will be required to maintain the vehicle speed. This relieves the load on the brake system and prevents the brakes from overheating and wearing too quickly.

Briefly depressing the accelerator pedal on downhill gradients while the manual drive program **M** is temporarily activated (vehicles with automatic transmission): the automatic transmission may switch back to the last active automatic drive program **E** or **S**. The automatic transmission may shift to a higher gear. This can reduce the engine's braking effect.

Heavy and light loads

WARNING

The braking system can overheat if you leave your foot on the brake pedal while driving. This increases the braking distance and could even cause the braking system to fail. There is a risk of an accident.

Never use the brake pedal as a footrest. Do not simultaneously depress both the brake pedal and the accelerator pedal while driving.

 Depressing the brake pedal constantly results in excessive and premature wear to the brake pads.

If heavy demands are made on the brakes, do not park the vehicle immediately. Drive on for a short while. This allows the airflow to cool the brakes more quickly.

If the brakes have been used only moderately, you should occasionally test their effectiveness. To do this, brake more firmly from a higher speed, paying attention to traffic conditions. This improves the grip of the brakes.

Wet road surfaces

If you have driven for a long time in heavy rain without braking, there may be a delayed reaction from the brakes when braking for the first time. This may also occur after a car wash or after driving through deep water.

You will have to depress the brake pedal more firmly. Maintain a greater distance to the vehicle in front.

After driving on a wet road or having the vehicle washed, brake firmly while paying attention to the traffic conditions. This will warm up the brake discs, thereby drying them more quickly and protecting them against corrosion.

Limited braking performance on salt-treated roads

If you drive on salt-treated roads, a layer of salt may form on the brake discs and pads. This can increase the braking distance considerably.

- In order to prevent any salt build-up, apply the brakes occasionally while paying attention to the traffic conditions.
- Carefully depress the brake pedal at the end of the journey and when starting the next journey.
- Maintain a much greater distance to the vehicle in front.

New brake pads/linings

Brake pads/linings and discs that are either new or have been replaced only achieve optimum braking effect after several hundred kilometres of driving. Compensate for the reduced braking effect by applying greater force to the brake pedal.

For safety reasons, Mercedes-Benz recommends that you only have brake pads/linings fitted to your vehicle which have been approved for Mercedes-Benz vehicles or which correspond to an equivalent quality standard. Brake pads/linings which have not been approved for Mercedes-Benz vehicles or which are not of an equivalent quality could affect your vehicle's operating safety.

Driving on wet roads

Aquaplaning

If the road surface is wet, aquaplaning may occur depending on water level, speed and tyre tread depth.

For this reason, drive in the following manner in the event of heavy rain or in conditions in which aquaplaning can occur:

- lower your speed
- avoid tyre ruts
- avoid sudden steering movements
- brake carefully

Driving on flooded roads

! Bear in mind that vehicles travelling in front or in the opposite direction create waves. This may cause the maximum permissible water depth to be exceeded.

These notes must be observed under all circumstances. You could otherwise damage the engine, the electronics or the transmission.

If you must drive on stretches of road on which water has collected, please bear in mind that:

- in the case of standing water, the water level must be no higher than the lower edge of the vehicle body
- you should drive no faster than walking pace

Winter driving

WARNING

If you shift down on a slippery road surface in an attempt to increase the engine's braking effect, the drive wheels could lose their grip. This increases the risk of skidding and having an accident.

Do not shift down for additional engine braking on a slippery road surface.

DANGER

If the exhaust pipe is blocked or adequate ventilation is not possible, poisonous gases such as carbon monoxide (CO) may enter the vehicle. This is the case, e.g. if the vehicle becomes trapped in snow. There is a risk of fatal injury.

If you leave the engine or the auxiliary heating running, make sure the exhaust pipe and area around the vehicle are clear of snow. To ensure an adequate supply of fresh air, open a

window on the side of the vehicle that is not facing into the wind.

Have your vehicle winterproofed at a qualified specialist workshop at the onset of winter.

You should drive particularly carefully on slippery road surfaces. Avoid sudden acceleration, steering and braking manoeuvres. Do not use cruise control or Distance Pilot DISTRONIC.

If the vehicle threatens to skid or cannot be stopped when moving at low speed:

- ▶ **Vehicles with manual transmission:** shift to neutral.
- ▶ **Vehicles with automatic transmission:** shift the transmission to position **N**.
- ▶ Try to bring the vehicle under control by using corrective steering.

The outside temperature indicator is not designed to serve as an ice-warning device and is therefore unsuitable for that purpose. Changes in the outside temperature are displayed after a short delay.

Indicated temperatures just above the freezing point do not guarantee that the road surface is free of ice. The road may still be icy, especially in wooded areas or on bridges.

You should pay special attention to road conditions when temperatures are around freezing point.

Further information on driving with snow chains (▷ page 319).

Further information on driving with summer tyres (▷ page 318).

Observe the notes in the "Winter operation" section (▷ page 318).

Driving systems

Cruise control

General notes

Cruise control maintains a constant road speed for you. It brakes automatically in order to avoid exceeding the set speed. You must select a lower gear in good time on long and steep downhill gradients, especially if the vehicle is laden or towing a trailer. For vehicles with automatic transmission, you need to shift manually using the steering wheel gearshift paddles to do this. By doing so, you will make use of the braking

effect of the engine. This relieves the load on the brake system and prevents the brakes from overheating and wearing too quickly.

When the engine is running, you can use the cruise control lever to limit the speed to any speed between 30 km/h and the maximum design speed of the vehicle. If the set value of the permanent limiter is lower, then this value applies (▷ page 168).

Use cruise control if road and traffic conditions make it appropriate to maintain a steady speed for a prolonged period.

The speed indicated in the speedometer may differ slightly from the speed stored.

Important safety notes

If you fail to adapt your driving style, cruise control can neither reduce the risk of an accident nor override the laws of physics. Cruise control cannot take into account road, weather or traffic conditions. Cruise control is only an aid. You are responsible for the distance to the vehicle in front, for vehicle speed, for braking in good time and for staying in lane.

Do not use cruise control:

- in road and traffic conditions that do not allow you to maintain a constant speed, e.g. in heavy traffic or on winding roads.
- on icy or slippery roads. Braking or accelerating can cause the drive wheels to lose traction and the vehicle could then skid.
- in poor visibility, e.g. due to fog, heavy rain or snow.

If a new driver takes over, advise the new driver of the speed stored.

Cruise control lever

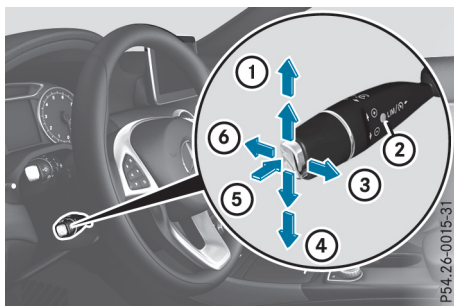

- ① To activate or increase speed
- ② LIM indicator lamp

- ③ To activate at the current speed/last stored speed
- ④ To activate or reduce speed
- ⑤ To switch between cruise control and the variable speed limiter
- ⑥ To deactivate cruise control

You can operate cruise control and the variable speed limiter with the cruise control lever.

The LIM indicator lamp on the cruise control lever indicates which system you have selected:

- **LIM indicator lamp off:** cruise control is selected
- **LIM indicator lamp on:** variable limiter is selected

When you activate cruise control, the stored speed is shown in the multifunction display for five seconds.

Selecting cruise control

- ▶ **To select cruise control:** check whether LIM indicator lamp ② is on or off. If it is off, cruise control is already selected.
- ▶ If it is not, press the cruise control lever in the direction of arrow ⑤. LIM indicator lamp ② in the cruise control lever goes out. Cruise control is selected.

Activation conditions

To activate cruise control, all of the following activation conditions must be fulfilled:

- the electric parking brake must be released
- you are driving faster than 30 km/h
- ESP® must be switched on, but not intervening
- on vehicles with automatic transmission, the transmission must be in position **D**.
- on vehicles with manual transmission, a gear must be engaged
- cruise control must be selected

Storing, maintaining and calling up a speed

Storing and maintaining the current speed

You can store the current speed if you are driving faster than 30 km/h.

- ▶ Accelerate the vehicle to the desired speed.
- ▶ Briefly press the cruise control lever up ① or down ④.
- ▶ Remove your foot from the accelerator pedal. Cruise control is activated. The vehicle automatically maintains the speed.

i Cruise control may be unable to maintain the stored speed on uphill gradients. The stored speed is resumed when the gradient evens out. Cruise control maintains the stored speed on downhill gradients by automatically braking the vehicle.

- i** Vehicles with manual transmission:
 - always drive at adequate, but not excessive, engine speeds.
 - change gear in good time.
 - if possible, do not change down several gears at a time.

Storing the current speed or re-calling the last stored speed

WARNING

If you call up a stored speed and this is different from the current speed, the vehicle accelerates or brakes. If you do not know what the stored speed is, the vehicle may accelerate or brake unexpectedly. There is a risk of an accident.

Take the traffic conditions into account before calling up the stored speed. If you do not know what the stored speed is, store the desired speed again.

- ▶ Briefly pull the cruise control lever towards you ③.
- ▶ Remove your foot from the accelerator pedal. The first time cruise control is activated, it stores the current speed or regulates the speed of the vehicle to the previously stored speed.

Setting a speed

Bear in mind that it may take a brief moment until the vehicle has accelerated or braked to the set speed.

- ▶ **To adjust the set speed in 10 km/h increments:** briefly press the cruise control lever

up ① beyond the pressure point for a higher speed, or down ② for a lower speed.

or

► Keep the cruise control lever pressed beyond the pressure point until the desired speed is set. Press the cruise control lever up ① for a higher speed or down ② for a lower speed.

► **To adjust the set speed in 1 km/h increments:** briefly press the cruise control lever up ① to the pressure point for a higher speed or down ② for a lower speed.

or

► Keep the cruise control lever pressed to the pressure point until the desired speed is set. Press the cruise control lever up ① for a higher speed or down ② for a lower speed.

❗ Cruise control is not deactivated if you depress the accelerator pedal. For example, if you accelerate briefly to overtake, cruise control adjusts the vehicle's speed to the last speed stored after you have finished overtaking.

Deactivating cruise control

There are several ways to deactivate cruise control:

► Briefly press the cruise control lever forwards ⑥.

or

► Brake.

or

► Briefly press the cruise control lever in the direction of arrow ⑤. The variable limiter is selected. LIM indicator lamp ② in the cruise control lever lights up.

Cruise control is automatically deactivated if:

- the vehicle is secured with the electric parking brake
- you are driving at less than 30 km/h
- ESP® intervenes or you deactivate ESP®
- while driving a vehicle with manual transmission, you shift into neutral or depress the clutch pedal for longer than six seconds
- on vehicles with manual transmission, you shift to a gear that is too high, and as a result the engine speed is too low
- on vehicles with automatic transmission, you shift to position **N** while driving

If cruise control is deactivated, you will hear a warning tone. You will see the **Cruise control off** message in the multifunction display for approximately five seconds.

❗ The last speed stored is cleared when you switch off the engine.

Speed limiter

General notes

The speed limiter restricts the vehicle speed. The speed limiter brakes automatically to quickly regulate the stored speed.

You must select a lower gear in good time on long and steep downhill gradients, especially if the vehicle is laden or towing a trailer. For vehicles with automatic transmission, you need to shift manually using the steering wheel gearshift paddles to do this. By doing so, you will make use of the braking effect of the engine. This relieves the load on the brake system and prevents the brakes from overheating and wearing too quickly.

You can set a variable or permanent limit speed:

- **Variable** for a maximum permissible speed, e.g. in built-up areas
- **Permanent** for restriction of the maximum design speed for technical reasons, such as when the vehicle is driven on winter tyres (▷ page 168)

❗ The speed indicated in the speedometer may differ slightly from the maximum permissible speed stored.

Important safety notes

If you fail to adapt your driving style, the speed limiter can neither reduce the risk of an accident nor override the laws of physics. The limiter cannot take into account road, weather or traffic conditions. The limiter is only an aid. You are responsible for the distance to the vehicle in front, for vehicle speed, for braking in good time and for staying in lane.

If a new driver takes over, advise the new driver of the speed stored.

Variable speed limiter

General notes

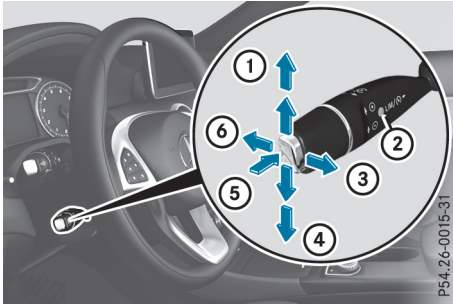

- ① To activate or increase speed
- ② LIM indicator lamp
- ③ To activate at the current speed/last stored speed
- ④ To activate or reduce speed
- ⑤ To switch between cruise control and the variable speed limiter
- ⑥ To switch off the speed limiter

With the cruise control lever, you can operate cruise control or Distance Pilot DISTRONIC and the variable speed limiter.

The LIM indicator lamp on the cruise control lever indicates which system you have selected:

- **LIM indicator lamp off:** cruise control or Distance Pilot DISTRONIC is selected.
- **LIM indicator lamp on:** variable speed limiter is selected.

When the engine is running, you can use the cruise control lever to limit the speed to any speed between 30 km/h and the maximum design speed of the vehicle. If the set value of the permanent limiter is lower, then this value applies (▷ page 168).

Selecting the variable speed limiter

- ▶ Check whether LIM indicator lamp ② is on. If it is on, the variable speed limiter is already selected. If it is not, press the cruise control lever in the direction of arrow ⑤. LIM indicator lamp ② in the cruise control lever lights up. The variable limiter is selected.

Storing the current speed

You can use the cruise control lever to limit the speed to any speed above 30 km/h while the engine is running.

- ▶ Briefly press the cruise control lever up ① or down ④. The current speed is stored and shown in the multifunction display.

Storing or calling up the speed

⚠ WARNING

If you call up the stored speed and it is lower than the current speed, the vehicle decelerates. If you do not know the stored speed, the vehicle could decelerate unexpectedly. There is a risk of an accident.

Pay attention to the road and traffic conditions before calling up the stored speed. If you do not know the stored speed, store the desired speed again.

- ▶ Briefly pull the cruise control lever towards you ③.

Setting a speed

- ▶ **To adjust the set speed in 10 km/h increments:** briefly press the cruise control lever up ① beyond the pressure point for a higher speed, or down ④ for a lower speed.

or

- ▶ Keep the cruise control lever pressed beyond the pressure point until the desired speed is set. Press the cruise control lever up ① for a higher speed or down ④ for a lower speed.

- ▶ **To adjust the set speed in 1 km/h increments:** briefly press the cruise control lever up ① to the pressure point for a higher speed or down ④ for a lower speed.

or

- ▶ Keep the cruise control lever pressed to the pressure point until the desired speed is set. Press the cruise control lever up ① for a higher speed or down ④ for a lower speed.

Switching the variable limiter to passive

If you depress the accelerator pedal beyond the pressure point (kickdown), the variable limiter switches to passive mode. The **Limiter passive** message appears in the multifunction display.

You can then exceed the stored speed. The variable limiter is activated again if, without kick-down, you:

- drive more slowly than the stored speed
- set a new speed or
- call up the last speed stored again

The **Limiter passive** message in the multifunction display disappears.

Switching off the variable speed limiter

You cannot switch the variable speed limiter off by braking.

There are several ways to deactivate the variable speed limiter:

- ▶ Briefly press the cruise control lever forwards .

or

- ▶ Briefly press the cruise control lever in the direction of arrow .

LIM indicator lamp  in the cruise control lever goes out. The variable speed limiter is switched off.

Cruise control or Distance Pilot DISTRONIC is selected.



Vehicles with manual transmission: the limiter switches off if you shift to a higher gear and as a result, the engine speed is too low.

-  The last speed stored is cleared when you switch off the engine.

Permanent limiter

If you wish to restrict the maximum speed of the vehicle for an extended period (e.g. when driving with winter tyres), the desired maximum speed can be set with the permanent limiter.

You can use the on-board computer to limit the speed to a value between 160 km/h and 240 km/h (▷ page 213).

Shortly before the stored speed is reached, it appears in the multifunction display. When you confirm the message with  or , the display is suppressed until you next switch off the engine. The speed will only be displayed again once the engine has been restarted.

The permanent limiter remains active even if the variable limiter is deactivated. The driven speed will remain below the stored speed even in the event of kickdown.

Distance Pilot DISTRONIC

General notes

Distance Pilot DISTRONIC regulates the speed and automatically helps you maintain the distance to the vehicle detected in front. The system detects vehicles using the radar sensor system. Distance Pilot DISTRONIC brakes automatically to avoid exceeding the set speed or to maintain the designated distance from the vehicle in front.

If Distance Pilot DISTRONIC detects that there is a risk of a collision with the vehicle in front, you will be warned visually and audibly. Without your intervention, Distance Pilot DISTRONIC cannot prevent a collision. An intermittent warning tone will then sound and the distance warning lamp will light up on the instrument cluster. Brake immediately to increase the distance to the vehicle in front, or take evasive action, provided it is safe to do so.

Distance Pilot DISTRONIC operates in the range between 0 km/h and 200 km/h.

Shift to a lower gear in good time on long and steep downhill gradients. Take particular note of this when driving a laden vehicle. By doing so, you will make use of the braking effect of the engine. This relieves the load on the brake system and prevents the brakes from overheating and wearing too quickly.

Do not use Distance Pilot DISTRONIC on roads with steep gradients.

For Distance Pilot DISTRONIC to assist you when driving, the radar sensor system must be operational.

Important safety notes

WARNING

Distance Pilot DISTRONIC does not recognise

- people or animals
- stationary objects on the road, e.g. stopped or parked vehicles
- oncoming vehicles or crossing traffic

As a result, Distance Pilot DISTRONIC may neither give warnings nor intervene in such situations. There is a risk of an accident.

Always pay careful attention to the traffic situation and be ready to brake.

⚠ WARNING

Distance Pilot DISTRONIC cannot always clearly identify other road users and complex traffic situations.

In such cases, Distance Pilot DISTRONIC may:

- give an unnecessary warning and then brake the vehicle
- neither give a warning nor intervene
- accelerate or brake unexpectedly

There is a risk of an accident.

Continue to drive carefully and be ready to brake, especially if Distance Pilot DISTRONIC warns you.

⚠ WARNING

Distance Pilot DISTRONIC brakes your vehicle with up to 50% of the maximum possible deceleration. If this deceleration is not sufficient, Distance Pilot DISTRONIC alerts you with a visual and acoustic warning. There is a risk of an accident.

Apply the brakes yourself in these situations and try to take evasive action.

! When Distance Pilot DISTRONIC or the HOLD function is activated, the vehicle brakes automatically in certain situations. To avoid damage to the vehicle, deactivate Distance Pilot DISTRONIC and the HOLD function in the following or similar situations:

- when towing away
- in a car wash

If you fail to adapt your driving style, Distance Pilot DISTRONIC can neither reduce the risk of an accident nor override the laws of physics. Distance Pilot DISTRONIC cannot take into account road, weather or traffic conditions. Distance Pilot DISTRONIC is only an aid. You are responsible for the distance to the vehicle in front, for vehicle speed, for braking in good time and for staying in lane.

Do not use Distance Pilot DISTRONIC:

- in road and traffic conditions that do not allow you to maintain a constant speed, e.g. in heavy traffic or on winding roads.
- on smooth or slippery roads. Braking or accelerating can cause the drive wheels to lose traction and the vehicle could then skid.
- in poor visibility, e.g. due to fog, heavy rain or snow.

Distance Pilot DISTRONIC may not detect narrow vehicles driving in front, e.g. motorcycles, or vehicles driving on a different line.

In particular, the detection of obstacles can be impaired in the following situations:

- dirt on the sensors or obscured sensors
- snow or heavy rain
- interference by other radar sources
- strong radar reflections, e.g. in multi-storey car parks

If Distance Pilot DISTRONIC no longer detects a vehicle in front, Distance Pilot DISTRONIC may unexpectedly accelerate to the speed stored.

This speed can:

- be too high for a filter lane or a slip road
- be so high on the right lane that you pass vehicles driving in the left lane
- be so high in the left lane that you pass vehicles driving in the right lane

If a new driver takes over, advise the new driver of the speed stored.

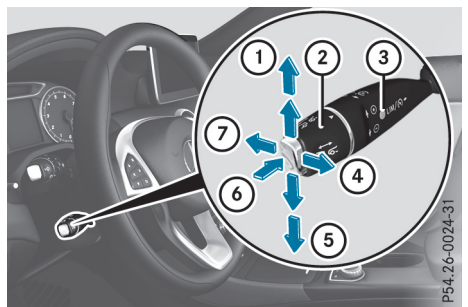
Cruise control lever

- ① To store the current speed or a higher speed
- ② To set the specified minimum distance
- ③ LIM indicator lamp
- ④ To store the current speed or re-call the last stored speed
- ⑤ To store the current speed or a lower speed

- ⑥ To switch between Distance Pilot DISTRONIC and the variable limiter
- ⑦ To deactivate Distance Pilot DISTRONIC

With the cruise control lever, you can operate Distance Pilot DISTRONIC and the variable limiter.

LIM indicator lamp ③ on the cruise control lever indicates which system you have selected:

- **LIM indicator lamp ③ off:** Distance Pilot DISTRONIC is selected.
- **LIM indicator lamp ③ on:** variable limiter is selected.

Selecting Distance Pilot DISTRONIC

- ▶ Check whether LIM indicator lamp ③ is off. If it is off, Distance Pilot DISTRONIC is already selected.
- ▶ If it is not, press the cruise control lever in the direction of arrow ④. LIM indicator lamp ③ in the cruise control lever goes out. Distance Pilot DISTRONIC is selected.

Activating Distance Pilot DISTRONIC

Activation conditions

! When Distance Pilot DISTRONIC or the HOLD function is activated, the vehicle brakes automatically in certain situations. To avoid damage to the vehicle, deactivate Distance Pilot DISTRONIC and the HOLD function in the following or similar situations:

- when towing away
- in a car wash

To activate Distance Pilot DISTRONIC, the following conditions must be fulfilled:

- the engine must be running. It may take up to two minutes of driving before Distance Pilot DISTRONIC is ready for use.
- the electric parking brake must be released.
- ESP® must be switched on, but not intervening.
- Parking Pilot must not be activated.
- the transmission must be in position **D**.
- the driver's door must be closed when you shift from **P** to **D** or your seat belt must be fastened.

- the front-passenger door must be closed.
- the vehicle must not be skidding.

Activating

- ▶ Briefly pull the cruise control lever towards you ④, up ① or down ⑤. Distance Pilot DISTRONIC is activated.
- ▶ Keep the cruise control lever pressed up ① or down ⑤ until the desired speed is set.
- ▶ Remove your foot from the accelerator pedal. Your vehicle adapts its speed to that of the vehicle in front, but only up to the desired stored speed.

i If you do not fully release the accelerator pedal, the **Distance Pilot passive** message appears in the multifunction display. The set distance to a slower-moving vehicle in front will then not be maintained. The position of the accelerator pedal will determine the speed.

You can also activate Distance Pilot DISTRONIC when stationary. The lowest speed that can be set is 30 km/h.

Driving with Distance Pilot DISTRONIC

Activating at the current speed/last stored speed

WARNING

If you call up a stored speed and this is different from the current speed, the vehicle accelerates or brakes. If you do not know what the stored speed is, the vehicle may accelerate or brake unexpectedly. There is a risk of an accident.

Take the traffic conditions into account before calling up the stored speed. If you do not know what the stored speed is, store the desired speed again.

- ▶ Briefly pull the cruise control lever towards you ④.
- ▶ Remove your foot from the accelerator pedal. The first time Distance Pilot DISTRONIC is activated, it stores the current speed or regulates the speed of the vehicle to the previously stored speed.

Pulling away and driving

► If you want to pull away with Distance

Pilot DISTRONIC: remove your foot from the brake pedal.

- Briefly pull the cruise control lever towards you ④.

or

► If Distance Pilot DISTRONIC is activated:

accelerate briefly.

Your vehicle pulls away and adapts its speed to that of the vehicle in front. If no vehicle is detected in front, your vehicle accelerates to the set speed.

The vehicle can also pull away when it is facing an unidentified obstacle or is driving on a different line from another vehicle. The vehicle then brakes automatically. Be ready to brake at all times.

If there is no vehicle in front, Distance Pilot DISTRONIC operates in the same way as cruise control.

If Distance Pilot DISTRONIC detects a slower-moving vehicle in front, it brakes your vehicle. In this way, the distance you have selected is maintained.

If Distance Pilot DISTRONIC detects a faster-moving vehicle in front, it increases the driving speed. However, the vehicle is only accelerated up to the speed you have stored.

- ① Distance Pilot DISTRONIC is deactivated when you depress the brake, except when the vehicle is stationary.

Selecting the drive program

Distance Pilot DISTRONIC supports a sporty driving style when you select the **S+** drive program (▷ page 150) or manual gearshifting (▷ page 152). Acceleration behind the vehicle in front or to the set speed is then noticeably more dynamic. If you have selected the **E (C** in Mercedes-AMG vehicles:)) drive program, the vehicle accelerates more gently. This setting is recommended in stop-start traffic.

Changing lanes

If you want to change to the overtaking lane on multi-lane roads, Distance Pilot DISTRONIC supports you if:

- you are driving faster than 70 km/h
- Distance Pilot DISTRONIC is maintaining the distance to a vehicle in front

- you switch on the respective turn signal
- Distance Pilot DISTRONIC does not currently detect a danger of collision

If these conditions are met, your vehicle accelerates. Acceleration will be interrupted if changing lanes takes too long or if the distance between your vehicle and the vehicle in front becomes too small.

Stopping

If Distance Pilot DISTRONIC detects that the vehicle in front is stopping, it brakes your vehicle until it is stationary.

Once your vehicle is stationary, it remains stationary and you do not need to depress the brake.

- ① After a short period, the vehicle is secured by the electric parking brake, thus relieving the service brake.
- ① Depending on the specified minimum distance, your vehicle will come to a standstill at a sufficient distance behind the vehicle in front. The specified minimum distance is set using the control on the cruise control lever.

When Distance Pilot DISTRONIC is activated, the transmission is shifted automatically to position **P** if:

- the driver's seat belt is not fastened and the driver's door is open
- the engine is switched off, unless it is automatically switched off by the ECO start/stop function

The electric parking brake is applied automatically if Distance Pilot DISTRONIC is active when the vehicle is stationary and:

- a system fault occurs
- the power supply is insufficient

If a fault occurs, the transmission may also shift to position **P** automatically.

Setting a speed

Bear in mind that it may take a brief moment until the vehicle has accelerated or braked to the set speed.

- Press the cruise control lever up ① for a higher speed or down ② for a lower speed.
- Keep the cruise control lever pressed until the desired speed is reached or press the cruise

control lever repeatedly until the desired speed is reached.

- ▶ Release the cruise control lever. The new speed is stored. Distance Pilot DISTRONIC is activated and adjusts the vehicle's speed to the new speed stored.
- ▶ **To adjust the set speed in 1 km/h increments:** briefly press the cruise control lever up ① or down ⑤ to the pressure point. The last stored speed increases or decreases in 1 km/h increments.
- ▶ **To adjust the set speed in 10 km/h increments:** briefly press the cruise control lever up ① or down ⑤ beyond the pressure point. The last stored speed increases or decreases in 10 km/h increments.

i Distance Pilot DISTRONIC is not deactivated if you depress the accelerator pedal. If you accelerate to overtake, Distance Pilot DISTRONIC adjusts the vehicle's speed to the last speed stored after you have finished overtaking.

Setting the specified minimum distance

You can set the specified minimum distance for Distance Pilot DISTRONIC by varying the time span between one and two seconds. With this function, you can set the minimum distance that Distance Pilot DISTRONIC maintains to the vehicle in front, dependent on the vehicle speed. You can see this distance in the multifunction display (▷ page 173).

The specified minimum distance can be changed while Distance Pilot DISTRONIC is switched on or off.

i Make sure that you maintain the minimum distance to the vehicle in front as required by law. Adjust the distance to the vehicle in front if necessary.

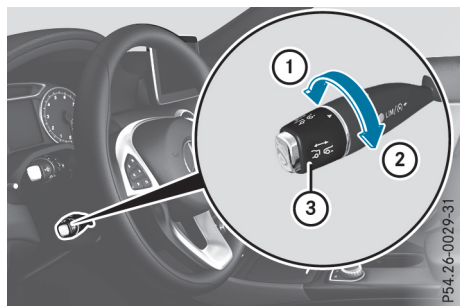

- ▶ **To increase:** turn control ③ in direction ②. Distance Pilot DISTRONIC then maintains a greater distance between your vehicle and the vehicle in front.
- ▶ **To decrease:** turn control ③ in direction ①. Distance Pilot DISTRONIC then maintains a shorter distance between your vehicle and the vehicle in front.

Deactivating Distance Pilot DISTRONIC

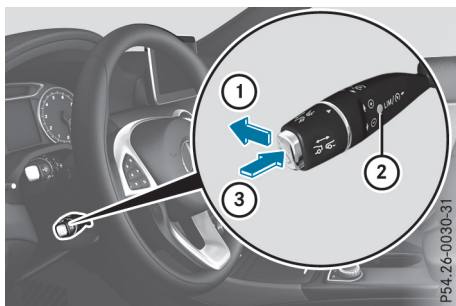

There are several ways to deactivate Distance Pilot DISTRONIC:

- ▶ Briefly press the cruise control lever forwards ①.
- or
- ▶ Brake, unless the vehicle is stationary.
- or
- ▶ Briefly press the cruise control lever in the direction of arrow ③. The variable limiter is selected. LIM indicator lamp ② in the cruise control lever lights up.
- ▶ Briefly press the cruise control lever forwards ①.
- or
- ▶ Brake, unless the vehicle is stationary.

When you deactivate Distance Pilot DISTRONIC, the **Distance Pilot off** message appears in the multifunction display for approximately five seconds.

i The last speed stored remains stored until you switch off the engine. Distance Pilot DISTRONIC is not deactivated if you depress the accelerator pedal.

Distance Pilot DISTRONIC is automatically deactivated if:

- you apply the electric parking brake or if the vehicle is automatically secured with the electric parking brake
- ESP® intervenes or you deactivate ESP®
- the transmission is in position **P**, **R** or **N**
- you pull the cruise control lever towards you in order to pull away and the front-passenger door or one of the rear doors is open
- the vehicle is skidding
- you activate Parking Pilot

If Distance Pilot DISTRONIC is deactivated automatically, you will hear a warning tone. The **Distance Pilot off** message will appear in the multifunction display for approximately five seconds.

Distance Pilot DISTRONIC is also automatically deactivated when you activate DSR. The  DSR symbol appears in the multifunction display.

Distance Pilot DISTRONIC displays in the instrument cluster

Displays on the speedometer

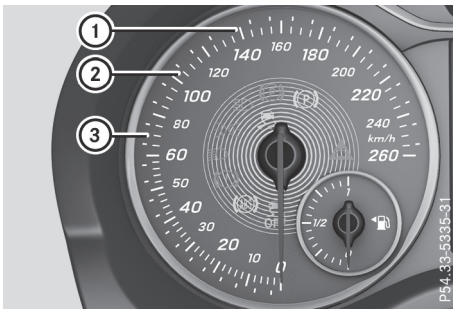

When Distance Pilot DISTRONIC PLUS is activated and there are no vehicles detected in front, one or two segments ② in the set speed range light up.

If Distance Pilot DISTRONIC detects a vehicle in front, segments ② between speed of the vehicle in front ③ and stored speed ① light up.

- i** For design reasons, the speed displayed in the speedometer may differ slightly from the speed set for Distance Pilot DISTRONIC.

Display when Distance Pilot DISTRONIC is deactivated

In the Assistance menu (▷ page 210) of the on-board computer, you can select the assistance graphic display.

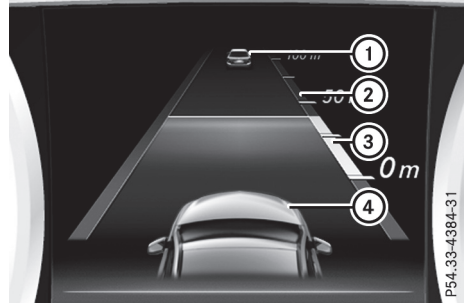

- ① Vehicle in front, if detected
- ② Distance indicator: current distance to the vehicle in front
- ③ Specified minimum distance to the vehicle in front; adjustable
- ④ Own vehicle

▶ Select the **Assistance graphic** function using the on-board computer (▷ page 210).

Display when Distance Pilot DISTRONIC is activated

You will initially see the stored speed for about five seconds when you activate Distance Pilot DISTRONIC.

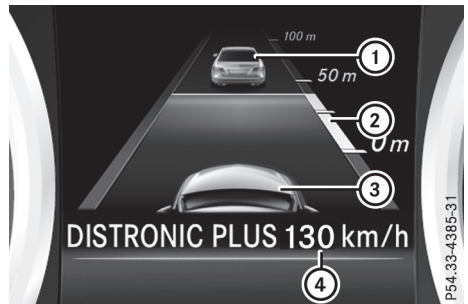

- ① Vehicle in front, if detected
- ② Specified minimum distance to the vehicle in front; adjustable
- ③ Own vehicle
- ④ Distance Pilot DISTRONIC active (text only appears when the cruise control lever is actuated)

- ▶ Select the **Assistance graphic** function using the on-board computer (▷ page 210).

Tips for driving with Distance Pilot DISTRONIC

General notes

Pay particular attention in the following traffic situations:

- Cornering, entering and exiting a bend: the ability of Distance Pilot DISTRONIC to detect vehicles when cornering is limited. Your vehicle may brake unexpectedly or late.
- Driving on a different line: Distance Pilot DISTRONIC may not detect vehicles driving in a different lane. The distance to the vehicle in front will be too short.
- Other vehicles changing lane: Distance Pilot DISTRONIC has not detected the vehicle cutting in yet. The distance to this vehicle will be too short.
- Narrow vehicles: Distance Pilot DISTRONIC does not detect the vehicle in front on the edge of the carriageway because of its narrow width. The distance to the vehicle in front will be too short.
- Obstacles and stationary vehicles: Distance Pilot DISTRONIC does not brake for obstacles or stationary vehicles. If, for example, the detected vehicle turns a corner and an obstacle or stationary vehicle is revealed, Distance Pilot DISTRONIC will not brake for them.
- Distance Pilot DISTRONIC may mistakenly detect vehicles that are crossing your lane. If you activate Distance Pilot DISTRONIC under the following conditions, the vehicle could pull away unintentionally:
 - at traffic lights with crossing traffic, for example
 - if there is a vehicle in front after a crossing with the HOLD function activated

In such situations, brake if necessary. Distance Pilot DISTRONIC is then switched off.

HOLD function

General notes

The HOLD function can assist the driver in the following situations:

- when pulling away, especially on steep slopes
- when manoeuvring on steep slopes
- when waiting in traffic

The vehicle is kept stationary without the driver having to depress the brake pedal.

The braking effect is cancelled and the HOLD function deactivated when you depress the accelerator pedal to pull away.

Important safety notes

WARNING

If the vehicle is only braked using the HOLD function, the vehicle may roll away in the following situations when you leave the vehicle:

- if there is a malfunction in the system or in the voltage supply
- if the HOLD function is deactivated by depressing the accelerator pedal or brake pedal, e.g. by a vehicle occupant
- if the electrical system in the engine compartment, the battery or the fuses are tampered with or the battery is disconnected

There is a risk of an accident.

Always deactivate the HOLD function and secure the vehicle against rolling away before you leave it.

- When Distance Pilot DISTRONIC or the HOLD function is activated, the vehicle brakes automatically in certain situations. To avoid damage to the vehicle, deactivate Distance Pilot DISTRONIC and the HOLD function in the following or similar situations:
 - when towing away
 - in a car wash

Deactivating the HOLD function (▷ page 175).

Activation conditions

You can activate the HOLD function if:

- the vehicle is stationary
- the engine is running or if it has been automatically switched off by the ECO start/stop function
- the driver's door is closed or if your seat belt is fastened
- the electric parking brake is released
- Distance Pilot DISTRONIC is deactivated
- the transmission is in position **D**, **R** or **N** in vehicles with automatic transmissions

Activating the HOLD function



- ▶ Make sure that the activation conditions are met.
- ▶ Depress the brake pedal.
- ▶ Quickly depress the brake pedal further until ① appears on the multifunction display. The HOLD function is activated. You can release the brake pedal.

i If depressing the brake pedal the first time does not activate the HOLD function, wait briefly and then try again.

Deactivating the HOLD function

The HOLD function is deactivated automatically if:

- you accelerate. In vehicles with automatic transmissions: only when the transmission is in position **D** or **R**.
- the transmission is in position **P** in vehicles with automatic transmissions.
- you depress the brake pedal again with a certain amount of pressure until ① disappears from the multifunction display.
- you activate Distance Pilot DISTRONIC.
- you secure the vehicle using the electric parking brake

i After a short period, the vehicle is secured by the electric parking brake, thus relieving the service brake.

Vehicles with automatic transmissions

When the HOLD function is activated, the transmission is automatically shifted to position **P** if:

- the driver's seat belt is not fastened and the driver's door is open
- the engine is switched off, unless it is automatically switched off by the ECO start/stop function

The electric parking brake secures the vehicle automatically if the HOLD function is activated, the vehicle is stationary and:

- a system fault occurs
- the power supply is insufficient

Vehicles with manual transmissions

The electric parking brake secures the vehicle automatically if the HOLD function is activated and:

- the driver's seat belt is not fastened and the driver's door is open
- the engine is switched off, unless it is automatically switched off by the ECO start/stop function
- a system fault occurs
- the power supply is insufficient

The **Brake immediately** message may also appear on the multifunction display.

- ▶ Immediately depress the brake pedal firmly until the warning message on the multifunction display disappears.

The HOLD function is deactivated.

A horn will sound at regular intervals if you turn off the engine, take off your seat belt or open the driver's door when the HOLD function is activated. The horn alerts you to the fact that the HOLD function is still activated. If you attempt to lock the vehicle, the horn becomes louder. The vehicle cannot be locked until you have deactivated the HOLD function.

i After the engine has been switched off, it can be restarted only once the HOLD function has been deactivated.

Start-off Assist (except Mercedes-AMG vehicles)**Important safety notes****⚠ WARNING**

If you use start-off assist, individual wheels may start to spin and the vehicle may skid. If ESP® is deactivated, there is a greater danger of skidding and having an accident. Make sure that no persons or obstacles are in the area around the vehicle.

Start-off assist enables optimum acceleration from a standstill. For this, a suitably high-grip surface is required; the tyres and vehicle must also be in good condition. Do not activate start-off assist on public roads. Observe the safety notes on driving safety systems (▷ page 65). Be sure to read the safety notes and information on ESP® (▷ page 69).

Activating start-off assist

- ▶ Deactivate ESP® (▷ page 210).
- ▶ Turn the steering wheel to the straight-ahead position.
- ▶ Firmly depress the brake pedal with your left foot and keep it depressed.
- ▶ Shift the transmission to position **D**.
- ▶ Use the DYNAMIC SELECT button to select the **S** drive program (▷ page 143).
- ▶ Quickly depress the accelerator pedal fully.
- ▶ Take your foot off the brake, but keep the accelerator pedal depressed. The vehicle pulls away at maximum acceleration.
- i** Activate ESP® as soon as the acceleration process has ended. ESP® will otherwise not be able to stabilise the vehicle if the vehicle starts to skid or a wheel starts to spin.

Cancelling start-off assist

- ▶ Remove your foot from the accelerator pedal.
- ▶ Reactivate ESP®.

RACE START (Mercedes-AMG vehicles)**Important safety notes**

- i** RACE START must not be used on normal roads. RACE START must be activated and used only on dedicated race circuits, not on public roads.
- i** RACE START is only available in Mercedes-AMG vehicles.

⚠ WARNING

If you use RACE START, individual tyres may get into a spin and the vehicle could skid. Depending on the selected ESP® mode, there is an increased risk of skidding and having an accident. Make sure that no persons, animals or obstacles are within range of the vehicle.

RACE START enables optimum acceleration from a standing start. For this, a suitably high-grip surface is required; the tyres and vehicle must also be in good condition.

- i** Observe the safety notes on driving safety systems (▷ page 65). Be sure to read the safety notes and information on ESP® (▷ page 69).

Activation conditions

You can activate RACE START if:

- the doors, the bonnet and the boot lid are closed
- the engine is running and the transmission, traction control and engine are at operating temperature
- the steering wheel is in the straight-ahead position
- the vehicle is stationary and the brake pedal is depressed (left foot)
- the transmission is in position **D**
- drive program **S**, **S+** or **RACE** is selected (▷ page 143)

Activating RACE START

- ▶ Depress the brake pedal with your left foot and keep it depressed.
- ▶ Pull and hold both steering wheel gearshift paddles.

- ▶ The **RACE START Confirm: Paddle UP Cancel: Paddle DOWN** message appears in the multifunction display.
- ▶ Release both steering wheel gearshift paddles.
- ❶ If the activation conditions are no longer fulfilled, RACE START is cancelled. The **RACE START not possible See Owner's Manual** message appears in the multifunction display.

- ▶ **To cancel:** pull the left steering wheel gearshift paddle (▷ page 152).

or

- ▶ **To confirm:** pull the right steering wheel gearshift paddle (▷ page 152). The **RACE START available Depress accelerator** message appears in the multifunction display.

- ❶ If you do not depress the accelerator pedal within a few seconds, RACE START is cancelled. The multifunction display shows the **RACE START cancelled** message.

- ▶ Fully depress the accelerator pedal. The engine speed increases. The **RACE START Release brake to start** message appears in the multifunction display.

- ❶ If the brake pedal is not released after a short while, RACE START is cancelled. The multifunction display shows the **RACE START cancelled** message.

- ▶ Take your foot off the brake, but keep the accelerator pedal depressed. The vehicle pulls away at maximum acceleration.

The **RACE START active** message appears in the multifunction display.

RACE START is deactivated when the vehicle reaches a speed of approximately 50 km/h.

RACE START is deactivated immediately if you release the accelerator pedal during RACE START or if any of the activation conditions are no longer fulfilled. The **RACE START not possible See Owner's Manual** or **RACE START cancelled** message appears in the multifunction display.

- ❶ After using it several times in short succession, RACE START will be unavailable until a certain distance has been driven.

AMG RIDE CONTROL

General notes

The electronically controlled damping system works continuously. This improves driving safety and ride comfort.

The damping is adjusted individually to each wheel and depends on:

- your driving style, e.g. sporty
- the road surface condition, e.g. bumps
- your individual selection of **Sport** or **Comfort**

The suspension setting is adjusted using the corresponding button on the centre console.

- ❶ The mode can also be set using the AMG DYNAMIC SELECT controller (▷ page 143).

If the ignition has been switched off for less than four hours, the last drive program selected remains activated when the engine is next started. If the ignition has been switched off for more than four hours, the **Comfort** setting is activated when the engine is next started.

Sport mode

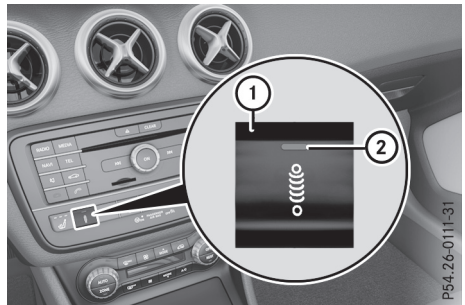

The firmer setting of the suspension tuning in **SPORT** mode ensures even better contact with the road. Select this mode when employing a sporty driving style, e.g. on winding country roads.

- ▶ Press button ❶ once. Indicator lamp ❷ lights up. You have selected **Sport** mode.

The **AMG Ride Control SPORT** message appears on the multifunction display.

Comfort mode

In **Comfort** mode, the driving characteristics of your vehicle are more comfortable. Select this mode if you prefer a more comfortable driving style, but also when driving at speed on straight roads, e.g. motorways.

- ▶ Press button ① again to switch off indicator lamp ②.

You have selected **Comfort** mode.

The **AMG Ride Control COMFORT** message appears on the multifunction display.

4MATIC

- ⚠ Never tow the vehicle with one axle raised. This may damage the differential. Damage of this sort is not covered by the Mercedes-Benz implied warranty. All wheels must remain either on the ground or be fully raised. Observe the instructions for towing the vehicle with all wheels in full contact with the ground.

4MATIC, together with ESP®, improves the traction of your vehicle whenever a drive wheel spins due to insufficient grip.

If you fail to adapt your driving style, 4MATIC can neither reduce the risk of an accident nor override the laws of physics. 4MATIC cannot take account of road, weather and traffic conditions. 4MATIC is only an aid. You are responsible for the distance to the vehicle in front, for vehicle speed, for braking in good time and for staying in lane.

If a drive wheel spins due to insufficient grip:

- when pulling away, only depress the accelerator pedal as far as is necessary.
- accelerate less when driving.

- ⓘ In wintry driving conditions, the maximum effect of 4MATIC can only be achieved if you use winter tyres (M+S tyres), with snow chains if necessary.

DYNAMIC BODY CONTROL

General notes

DYNAMIC BODY CONTROL provides improved driving comfort and continuously controls the damper settings. The damping characteristics

adapt to the current operating and driving situation.

The damping is adjusted individually to each wheel and depends on:

- your driving style, e.g. sporty
- the road surface conditions
- the drive program selected

The drive program can be set using the DYNAMIC SELECT button (▷ page 143).

Selecting Comfort mode

In the **Comfort** drive program, the driving characteristics of your vehicle are more comfortable. Select this drive program if you prefer a more comfortable driving style. Also select the **Comfort** drive program when driving at speed on straight roads, e.g. on straight stretches of motorway.

- ▶ Press DYNAMIC SELECT button (▷ page 143) as many times as necessary until the **Comfort** drive program is selected.

Selecting Sport mode

The firmer suspension setting in the **Sport** drive program ensures even better contact with the road. Select this drive program when employing a sporty driving style, e.g. on winding country roads.

- ▶ Press DYNAMIC SELECT button (▷ page 143) as many times as necessary until the **Sport** drive program is selected.

PARKTRONIC Parking Assist

Important safety notes

Parking Assist PARKTRONIC is an electronic parking aid with ultrasound. It monitors the area around your vehicle using six sensors on the front bumper and six sensors on the rear bumper. Parking Assist PARKTRONIC shows you the distance between your vehicle and an obstacle visually and audibly.

Parking Assist PARKTRONIC is only an aid. It is not a substitute for your attention to the immediate surroundings. The responsibility for safe manoeuvring and parking remains with you. Make sure that there are no persons, animals or

objects in the manoeuvring area when you are manoeuvring or parking.

! When parking, pay particular attention to objects above or below the sensors, such as flower pots or trailer drawbars. Parking Assist PARKTRONIC does not detect such objects when they are in the immediate vicinity of the vehicle. You could damage the vehicle or the objects.

The sensors may not detect snow and other objects that absorb ultrasonic waves.

Ultrasonic sources such as an automatic car wash, the compressed-air brakes of a lorry or a pneumatic drill could cause Parking Assist PARKTRONIC to malfunction.

Parking Assist PARKTRONIC may not function correctly on uneven terrain.

! Fold in the ball coupling if the trailer tow hitch is not required. Parking Assist PARKTRONIC measures the minimum detection range to an obstacle from the bumper, not the ball coupling.

Parking Assist PARKTRONIC is activated automatically when you:

- switch on the ignition
- shift the transmission to position **D**, **R** or **N** for vehicles with automatic transmission

Parking Assist PARKTRONIC is deactivated at speeds above 18 km/h. It is reactivated at lower speeds.

Vehicles with a trailer tow hitch: Parking Assist PARKTRONIC is deactivated for the rear area when you establish the electrical connection between your vehicle and a trailer.

Range of the sensors

General notes

Parking Assist PARKTRONIC does not take into account obstacles located:

- below the detection range, e.g. persons, animals or objects
- above the detection range, e.g. overhanging loads, tail sections or loading ramps of goods vehicles

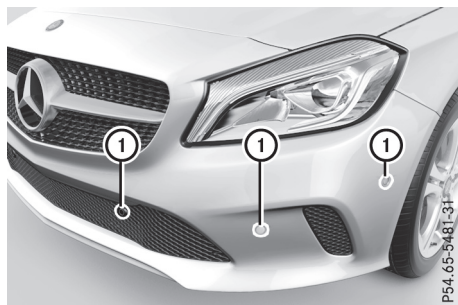

① Sensors on the front bumper, left-hand side (example)

The sensors must be free of dirt, ice and slush. Otherwise, they may not function correctly. Clean the sensors regularly, taking care not to scratch or damage them (> page 294).

Range

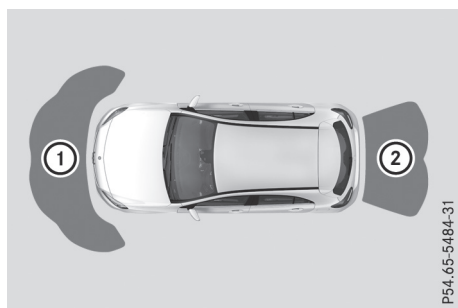

- ① Detection range of front sensors
② Detection range of rear sensors

Front sensors

Centre	Approx. 100 cm
Corners	Approx. 60 cm

Rear sensors

Centre	Approx. 120 cm
Corners	Approx. 80 cm

Minimum distance

Centre	Approx. 20 cm
Corners	Approx. 20 cm

If an obstacle is detected within this range, the relevant warning displays light up and a warning tone sounds. If the distance falls below the minimum, the distance may no longer be shown.

Warning displays

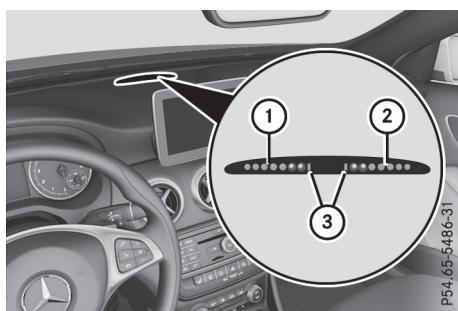

- ① Segments on the left-hand side of the vehicle
- ② Segments on the right-hand side of the vehicle
- ③ Segments showing operational readiness

The warning displays show the distance between the sensors and the obstacle. The warning display for the front area is located on the dashboard above the centre air vents. The warning display for the rear area is located on the roof lining in the rear compartment.

The warning display for each side of the vehicle is divided into five yellow and two red segments. If yellow segments ③ showing operational readiness light up, Parking Assist PARKTRONIC is operational.

The gear lever position or the transmission position of the automatic transmission and the direction in which the vehicle is rolling determine which warning display is active when the engine is running.

Manual transmission:

Gear lever position	Warning display
Forward gear or Neutral	Front area activated
Reverse gear or the vehicle is rolling backwards	Rear and front areas activated

Automatic transmission:

Transmission position	Warning display
D	Front area activated
R , N or the vehicle is rolling backwards	Rear and front areas activated
P	No areas activated

One or more segments light up as the vehicle approaches an obstacle, depending on the vehicle's distance from the obstacle. In addition, warning tones are emitted.

When the distance to the obstacle is sufficient, you will hear an intermittent warning tone. The shorter the distance to the obstacle, the shorter the frequency of the intermittent warning tones becomes. When the minimum distance is reached, you hear a continuous warning tone.

Deactivating/activating Parking Assist PARKTRONIC



- ① Indicator lamp
- ② Activating/deactivating Parking Assist PARKTRONIC

If indicator lamp ① lights up, Parking Assist PARKTRONIC is deactivated.

! Parking Assist PARKTRONIC is automatically activated when you turn the key to position ② in the ignition lock.

Problems with Parking Assist PARKTRONIC

Problem	Possible causes/consequences and ► Solutions
Only the red segments in the Parking Assist PARKTRONIC warning displays are lit. You also hear a warning tone for approximately two seconds. Parking Assist PARKTRONIC is then deactivated and the indicator lamp on the PARKTRONIC button lights up.	Parking Assist PARKTRONIC is malfunctioning and has been deactivated. ► If problems persist, have Parking Assist PARKTRONIC checked at a qualified specialist workshop.
Only the red segments in the Parking Assist PARKTRONIC warning displays are lit. Parking Assist PARKTRONIC is then deactivated.	The Parking Assist PARKTRONIC sensors are dirty or malfunctioning. ► Clean the Parking Assist PARKTRONIC sensors (▷ page 294). ► Switch the ignition back on. The problem may be caused by an external source of radio or ultrasound waves. ► Check to see if Parking Assist PARKTRONIC functions in a different location.

Parking Pilot

General notes

Parking Pilot is an electronic parking aid with ultrasound. It measures the road on both sides of the vehicle. A parking symbol indicates a suitable parking space. Active steering intervention and brake application can assist you during parking and when exiting a parking space. Parking Assist PARKTRONIC is also available (▷ page 178).

! The active braking application is only available on vehicles with automatic transmission.

Important safety notes

Parking Pilot is only an aid. It is not a substitute for your attention to the immediate surroundings. The responsibility for safe manoeuvring and parking remains with you. Make sure that

there are no persons, animals or objects in the manoeuvring area when you are manoeuvring or parking.

When Parking Assist PARKTRONIC is deactivated, Parking Pilot is also unavailable.

WARNING

While parking or pulling out of a parking space, the vehicle swings out and can drive onto areas of the oncoming lane. This could cause you to collide with other road users. There is a risk of an accident.

Pay attention to other road users. Stop the vehicle if necessary or cancel the Parking Pilot parking procedure.

! If you cannot avoid driving over obstacles, e.g. kerbs, do so slowly and at an obtuse angle only. You could otherwise damage the wheel rims and tyres.

Parking Pilot may also display spaces not suitable for parking, e.g.:

- in a zone where parking or stopping is prohibited
- in front of driveways or entrances and exits
- on unsuitable surfaces

Parking tips:

- on narrow roads, drive as closely as possible past the parking space
- parking spaces that are littered or overgrown might be identified or measured incorrectly
- parking spaces that are partially occupied by trailer drawbars might not be identified as such or be measured incorrectly
- snowfall or heavy rain may lead to a parking space being measured inaccurately
- pay attention to the Parking Assist PARKTRONIC warning messages (▷ page 180) during the parking procedure
- you can intervene in the steering procedure to correct it at any time. Parking Pilot will then be cancelled.
- when transporting a load that protrudes from your vehicle, you should not use Parking Pilot
- never use Parking Pilot when snow chains are fitted
- make sure that the tyre pressures are always correct. This has a direct influence on the parking characteristics of the vehicle

Use Parking Pilot for parking spaces that are:

- parallel or at right angles to the direction of travel
- on straight roads, not bends
- on the same level as the road, e.g. not on the pavement

For vehicles with the trailer tow hitch folded out, the minimum length for parking spaces is slightly longer.

If you have attached a trailer to your vehicle, you should not use Parking Pilot. Once the electrical connection is established between your vehicle and the trailer, Parking Pilot is no longer available. Parking Assist PARKTRONIC is deactivated for the rear area.

Detecting parking spaces

Objects located above the detection range of Parking Pilot will not be detected when the parking space is measured. These are not taken into account when the parking procedure is calcula-

ted, e.g. overhanging loads, tail sections or loading ramps of goods vehicles. Parking Pilot may therefore guide you into the parking space too early.

Parking Pilot does not assist you parking in spaces at right angles to the direction of travel if:

- two parking spaces are located directly next to one another
- the parking space is directly next to a low obstacle such as a low kerb
- you forward-park

Parking Pilot does not assist you parking in spaces parallel or at right angles to the direction of travel if:

- the parking space is on a kerb
- the system reads the parking space as being blocked, such as by foliage or grass paving blocks
- the area is too small for the vehicle to manoeuvre into
- the parking space is bordered by an obstacle, e.g. a tree, a post or a trailer

Further information on the detection range (▷ page 179).

⚠ WARNING

If there are objects above the detection range:

- Parking Pilot may steer in too early
- the vehicle may not stop in front of these objects

This could cause a collision. There is a risk of an accident.

If objects are located above the detection range, stop and deactivate Parking Pilot.

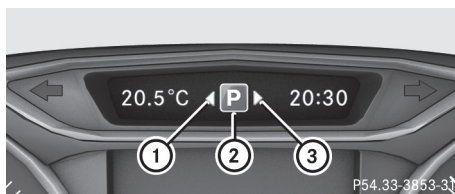

- ① Detected parking space on the left
- ② Parking symbol
- ③ Detected parking space on the right



Parking Pilot is activated automatically when you drive forwards. The system is operational at speeds of up to approximately 35 km/h. While in operation, the system independently locates

and measures parking spaces on both sides of the vehicle.

Parking Pilot will detect only parking spaces which are:

- parallel or at right angles to the direction of travel
- parallel to the direction of travel and at least 1.5 m wide
- parallel to the direction of travel and at least 1.0 m longer than your vehicle
- at right angles to the direction of travel and at least 1.0 m wider than your vehicle

i Note that Parking Pilot cannot measure the length of a parking space if it is at right angles to the direction of travel. You will need to judge whether your vehicle will fit in the parking space.

When driving at speeds below 30 km/h, you will see parking symbol  as a status indicator on the instrument cluster. When a parking space has been detected, an arrow towards the right or the left also appears. Parking Pilot displays only parking spaces on the front-passenger side as standard. Parking spaces on the driver's side are displayed as soon as the turn signal on the driver's side is activated. When parking on the driver's side, this must remain activated until you confirm the use of Parking Pilot by pressing the  button on the multifunction steering wheel. The system automatically determines whether the parking space is parallel or at right angles to the direction of travel.

A parking space is displayed while you are driving past it, and until you are approximately 15 m away from it.

Parking

WARNING

If you leave the vehicle when it is only being braked by Parking Pilot, it could roll away if:

- there is a malfunction in the system or in the voltage supply.
- the electrical system in the engine compartment, the battery or the fuses are tampered with.
- the battery is disconnected
- the vehicle is accelerated, e.g. by a vehicle occupant.

There is a risk of an accident.

Before leaving the vehicle, always secure it against rolling away.

i Vehicles with automatic transmissions:

If Parking Assist PARKTRONIC detects obstacles, Parking Pilot brakes automatically whilst the vehicle is parking. You are responsible for braking in good time.

► Stop the vehicle when the parking symbol shows the desired parking space in the instrument cluster.

► **Vehicles with automatic transmissions:** shift the transmission to position .

Vehicles with manual transmissions: shift to reverse gear.

The **Start Parking Pilot? Yes: OK No:**

 message appears on the multifunction display.

► **To cancel the procedure:** press the  button on the multifunction steering wheel or pull away.

or

► **To park using Parking Pilot:** press the  button on the multifunction steering wheel.

The **Parking Pilot active Accelerate and brake Observe surroundings** message appears on the multifunction display.

► Release the multifunction steering wheel.

► Reverse the vehicle, being ready to brake at all times. When reversing, drive at a speed below approximately 10 km/h. Otherwise, Parking Pilot is cancelled.

Vehicles with automatic transmissions:

Parking Pilot brakes the vehicle to a standstill when the vehicle approaches the rear border of the parking space.

Manoeuvring may be required in tight parking spaces.

► **Vehicles with manual transmissions:** stop as soon as Parking Assist PARKTRONIC sounds the continuous warning tone, if not before.

Manoeuvring may be required in tight parking spaces.

Vehicles with automatic transmissions: the **Park Pilot active Select D Observe surroundings** message appears on the multifunction display.

Vehicles with manual transmissions: the **Park Pilot active Engage forward gear Observe surroundings** message appears on the multifunction display.

► **Vehicles with automatic transmissions:** shift the transmission to position **[D]** while the vehicle is stationary.

Vehicles with manual transmissions: shift to first gear while the vehicle is stationary. Parking Pilot steers immediately in the other direction.

The **Parking Pilot active Accelerate and brake Observe surroundings** message appears on the multifunction display.

i You will achieve the best results by waiting for the steering procedure to complete before pulling away.

► Drive forwards and be ready to brake at all times.

Vehicles with automatic transmissions: Parking Pilot brakes the vehicle to a standstill when the vehicle approaches the front border of the parking space.

Manoeuvring may be required in tight parking spaces.

► **Vehicles with manual transmissions:** stop as soon as Parking Assist PARKTRONIC sounds the continuous warning tone, if not before.

Vehicles with automatic transmissions: the **Park Pilot active Select RObserve surroundings** message appears on the multifunction display.

Vehicles with manual transmissions: the **Park Pilot active Engage reverse gear Observe surroundings** message appears on the multifunction display.

As soon as the parking procedure is complete, the **Park Pilot ended** message appears and a warning tone sounds. The vehicle is now parked.

Vehicles with automatic transmissions: the vehicle is kept stationary without the driver having to depress the brake pedal. The braking effect is cancelled when you depress the accelerator pedal.

Parking Pilot no longer supports you with steering interventions and brake applications. When Parking Pilot has been switched off, you must steer and brake again yourself. Parking Assist PARKTRONIC is still available.

Parking tips:

- The way your vehicle is positioned in the parking space after parking is dependent on various factors. These include the positions and shapes of the vehicles parked in front of and behind it and the nature of the surroundings. It is possible that Parking Pilot could guide you too far or not far enough into a parking space. In some cases, it may also lead you across or onto the kerb. If necessary, cancel the parking procedure with Parking Pilot.
- You can also preselect transmission position **[D]**. The vehicle redirects and does not drive as far into the parking space. Should the transmission change take place too early, the parking procedure is cancelled. A reasonable parking position can no longer be achieved from this position.

Exiting a parking space

In order that Parking Pilot can support you when exiting the parking space:

- you need to have parked using Parking Pilot.
- the border of the parking space must be high enough at the front and the rear. A kerb stone is too small, for example.
- the border of the parking space must not be too wide, as the position of the vehicle must not exceed an angle of 45° to the starting position as it is manoeuvred into the parking space.
- a manoeuvring distance of at least 1.0 m must be available.

Parking Pilot can assist you with exiting a parking space only if you have parked the vehicle parallel to the direction of travel using the Parking Pilot.

- i** Vehicles with automatic transmissions:
- If Parking Assist PARKTRONIC detects obstacles, Parking Pilot brakes automatically whilst the vehicle is exiting the parking space. You are responsible for braking in good time.
- Start the engine.
 - Release the electric parking brake.
 - Switch on the turn signal in the direction you will drive out of the parking space.
 - **Vehicles with automatic transmission:** shift the transmission to position **[D]** or **[R]**.



Vehicles with manual transmission: shift to forward or reverse gear.

The **Start Parking Pilot? Yes: OK No:**

 message appears on the multifunction display.

- ▶ **To cancel the procedure:** press the  button on the multifunction steering wheel or pull away.

or

- ▶ **To exit a parking space using Parking Pilot:** press the  button on the multifunction steering wheel. The **Parking Pilot active Accelerate and brake Observe surroundings** message appears on the multifunction display.
- ▶ Release the multifunction steering wheel.
- ▶ Pull away, being ready to brake at all times. Do not exceed a maximum speed of approximately 10 km/h when exiting a parking space. Otherwise, Parking Pilot is cancelled.
- ▶ **Vehicles with manual transmission:** stop, when Parking Assist PARKTRONIC sounds the continuous warning tone, if not before.
- ▶ **Vehicles with automatic transmission:** depending on the message or as required, shift the transmission to position  or .

Vehicles with manual transmission:

depending on the message or as required, engage forward or reverse gear. Parking Pilot steers immediately in the other direction. The **Parking Pilot active Accelerate and brake Observe surroundings** message appears on the multifunction display.

- ❗ You will achieve the best results by waiting for the steering procedure to complete before pulling away. If you reverse after activation, the steering wheel is moved to the straight-ahead position.
- ▶ Drive forwards and reverse as prompted by the Parking Assist PARKTRONIC warning displays, several times if necessary.

Once you have exited the parking space completely, the steering wheel is moved to the straight-ahead position. You hear a tone and the **Parking Pilot ended** message appears on the multifunction display. You will then have to steer and merge into traffic on your own. Parking Assist PARKTRONIC is still available. You can take over the steering before the vehicle has exited the parking space completely. This is

useful, for example, when you recognise that it is already possible to pull out of the parking space.



Cancelling Parking Pilot

- ▶ Stop the movement of the multifunction steering wheel or steer yourself. Parking Pilot is cancelled at once. The **Parking Pilot cancelled** message appears in the multifunction display.

or

- ▶ Press the PARKTRONIC button (▷ page 180). Parking Assist PARKTRONIC is switched off and Parking Pilot is immediately cancelled. The **Parking Pilot cancelled** message appears in the multifunction display.

Parking Pilot is cancelled automatically when:

- the electric parking brake is applied
- transmission position  is selected in vehicles with automatic transmission
- parking using Parking Pilot is no longer possible
- you are driving at a speed greater than 10 km/h
- a wheel spins and ESP® intervenes or fails. In such cases the  warning lamp lights up on the instrument cluster

A warning tone sounds. The parking symbol disappears and the multifunction display shows the **Parking Pilot cancelled** message.

When Parking Pilot is cancelled, you must steer and brake again yourself.

If a system malfunction occurs, the vehicle is braked to a standstill. To drive on, depress the accelerator pedal again.

Reversing camera

General notes

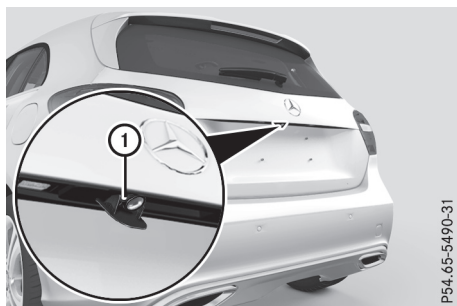

P54_65-5490-31

Reversing camera ① is an optical parking and manoeuvring aid. It shows the area behind your vehicle with guide lines in the multimedia system display.

The area behind the vehicle is displayed as a mirror image, as in the rear-view mirror.

Observe the notes on cleaning (▷ page 294).

i The text shown in the multimedia system display depends on the language setting. The following are examples of reversing camera messages in the multimedia system display.

Important safety notes

The reversing camera is only an aid. It is not a substitute for your attention to the immediate surroundings. The responsibility for safe manoeuvring and parking remains with you. Make sure that there are no persons, animals or objects in the manoeuvring area when you are manoeuvring or parking.

The reversing camera will not function or will function only to a limited extent:

- if the tailgate is open
- in heavy rain, snow or fog
- at night or in very dark places
- if the camera is exposed to very bright light
- if the area is lit by fluorescent lamps or LED lighting (the display may flicker)
- if there is a sudden change in temperature, e.g. when driving into a heated garage in winter

- if the camera lens is dirty or obstructed. Observe the notes on cleaning (▷ page 294)
- if the rear of your vehicle is damaged. In this case, have the camera position and setting checked at a qualified specialist workshop

The field of vision and other functions of the reversing camera may be restricted due to additional accessories on the rear of the vehicle (e.g. licence plate holder, rear-mounted bicycle rack).

i The contrast of the display may be affected by the sudden presence of sunlight or other light sources, e.g. when exiting a garage. Pay particular attention in this situation.

i If usability is severely restricted, e.g. due to pixel errors, have the display repaired or replaced.

Activating/deactivating the reversing camera

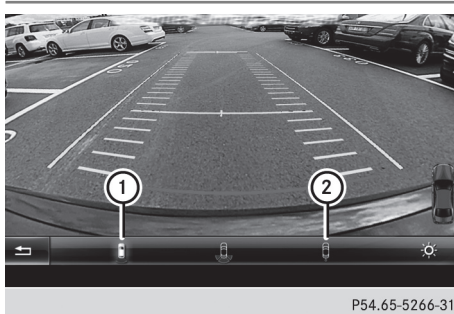

P54_65-5266-31

- ▶ **To activate:** make sure that the key is in position ② in the ignition lock.
- ▶ Make sure that the **Activation by R gear** function is selected in the multimedia system; see the Digital Owner's Manual.
- ▶ Engage reverse gear. The area behind the vehicle is shown with guide lines in the multimedia system display. The image from the reversing camera is available throughout the manoeuvring process.
- ▶ **To switch the function mode for vehicles with trailer tow hitch:** using the controller, select symbol ① for the "Reverse parking" function or symbol ② for "Coupling up a trailer". The symbol of the selected function is highlighted.

To deactivate: the reversing camera deactivates if you shift the transmission to **P** or after driving forwards a short distance.

If the complete system fails, the inner segments of the warning display are shown in red. The indicator lamp on the PARKTRONIC button lights up.

If the rear system fails:

- the rear segments are shown in red when reversing
- the rear segments are hidden when driving forward

Messages in the multimedia system display

The reversing camera may show a distorted view of obstacles or show them incorrectly or not at all. Obstacles are not shown by the reversing camera in the following locations:

- very close to the rear bumper
- under the rear bumper
- in the area immediately above the recessed tailgate handle

! Objects not at ground level may appear to be further away than they actually are, e.g.:

- the bumper of a parked vehicle
- the drawbar of a trailer
- the ball coupling of a trailer tow hitch
- the rear section of an HGV
- a slanted post

Use the guidelines only for orientation.

Approach objects no further than the bottom-most guideline.

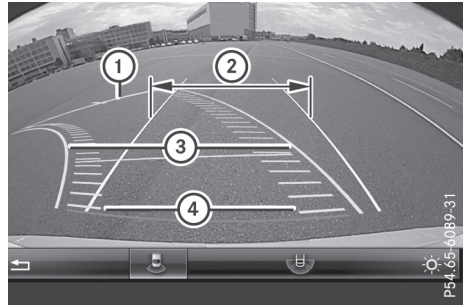

- ① Yellow guide line at a distance of approximately 4.0 m from the rear of the vehicle
- ② White guide line without steering input, vehicle width including the exterior mirrors (static)
- ③ Yellow guide line for vehicle width including the exterior mirrors, for current steering input (dynamic)
- ④ Yellow lanes marking the course the tyres will take for current steering input (dynamic)

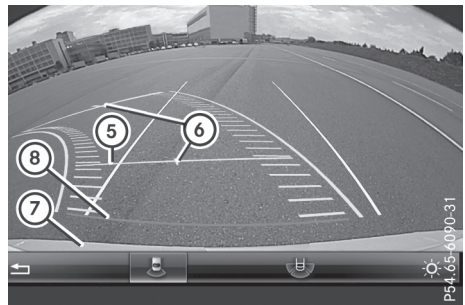

- ⑤ Yellow guide line at a distance of approximately 1.0 m from the rear of the vehicle
- ⑥ Vehicle centre axis (locating aid)
- ⑦ Bumper
- ⑧ Red guide line at a distance of approximately 0.30 m from the rear of the vehicle



P54.65-5272-31

- ① Front warning displays
- ② Additional measurement operational readiness indicator of the Parking Assist PARKTRONIC
- ③ Rear warning displays

When Parking Assist PARKTRONIC is operational (▷ page 180), additional measurement operational readiness indicator ② appears in the multimedia system display. If the Parking Assist PARKTRONIC warning displays are active or light up, warning displays ① and ③ are also active or light up correspondingly in the multimedia system display.

"Reverse parking" function

Reversing straight into a parking space without steering input

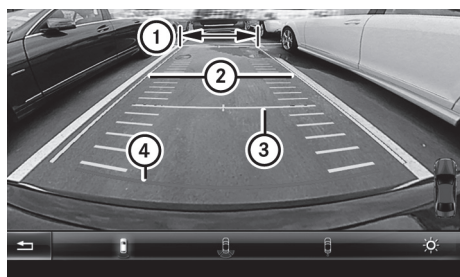

P54.65-5273-31

- ① White guide line without steering input, vehicle width including the exterior mirrors (static)
- ② Yellow guide line for vehicle width including the exterior mirrors, for current steering input (dynamic)
- ③ Yellow guide line at a distance of approximately 1.0 m from the rear of the vehicle
- ④ Red guide line at a distance of approximately 0.30 m from the rear of the vehicle

- ▶ Make sure that the reversing camera is switched on (▷ page 186). The lane and the guide lines are shown.
- ▶ With the help of white guide line ①, check whether the vehicle will fit into the parking space.
- ▶ Using white guide line ① as a guide, carefully reverse until you reach the end position. Red guide line ④ is then at the end of the parking space. The vehicle is almost parallel in the parking space.

Reverse perpendicular parking with steering input

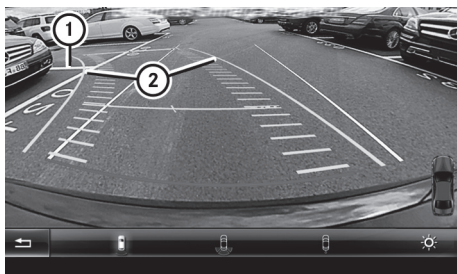

P54.65-5274-31

- ① Parking space marking
 - ② Yellow guide line for vehicle width including the exterior mirrors, for current steering input (dynamic)
- ▶ Drive past the parking space and bring the vehicle to a standstill.
 - ▶ Make sure that the reversing camera is switched on (▷ page 186). The lane and the guide lines are shown.
 - ▶ While the vehicle is stationary, turn the steering wheel in the direction of the parking space until yellow guide line ② reaches parking space marking ①.
 - ▶ Maintain the steering input and reverse carefully.

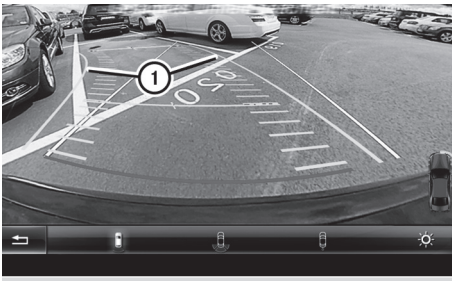

P54.65-5275-31

- ① Yellow guide line for vehicle width including the exterior mirrors, for current steering input (dynamic)
- ▶ Stop the vehicle when it is almost exactly in front of the parking space. The white lane should be as close to parallel with the parking space marking as possible.

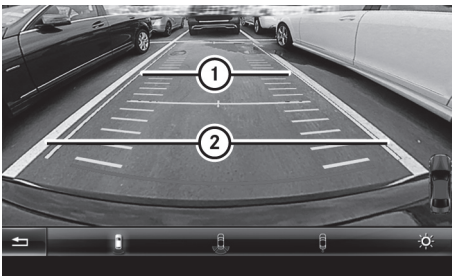

P54.65-5276-31

- ① White guide line at current steering input
- ② Parking space marking
- ▶ Turn the steering wheel to the centre position while the vehicle is stationary.

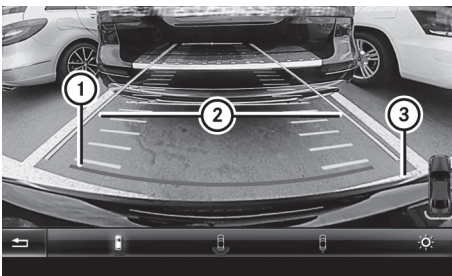

P54.65-5277-31

- ① Red guide line at a distance of approximately 0.30 m from the rear of the vehicle
- ② White guide line without steering input
- ③ End of parking space

- ▶ Reverse carefully until you have reached the end position. Red guide line ① is then at the end of parking space ③. The vehicle is almost parallel in the parking space.

"Coupling up a trailer" function

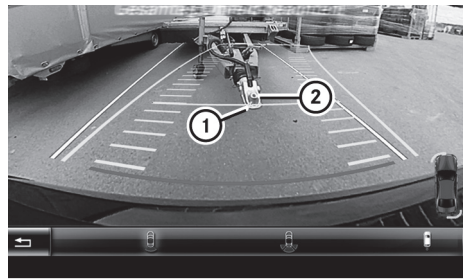

P54.65-4901-31

- ① Vehicle centre point on the yellow guide line at a distance of approximately 1.0 m from the rear of the vehicle
- ② Trailer drawbar

This function is available only on vehicles with a trailer tow hitch.

- ▶ Before coupling up a trailer, set the height of trailer drawbar ② so that it is slightly higher than the ball coupling.
- ▶ Position the vehicle centrally in front of trailer drawbar ②.

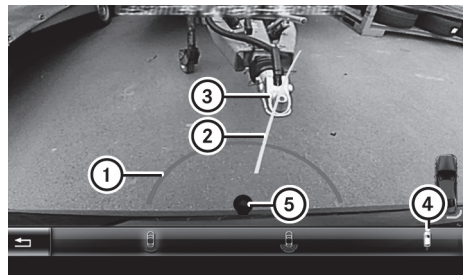

P54.65-4900-31

- ① Red guide line at a distance of approximately 0.30 m from the ball coupling
- ② Trailer drawbar locating aid
- ③ Trailer drawbar
- ④ Symbol for the "Coupling up a trailer" function
- ⑤ Ball coupling

- ▶ Select symbol ④ using the controller. The "Coupling up a trailer" function is selected. The distance specifications now apply only to objects that are at the same level as the ball coupling.
- ▶ Reverse carefully, making sure that trailer drawbar locating aid ② points approximately in the direction of trailer drawbar ③.
- ▶ Reverse carefully until trailer drawbar ③ reaches the red guide line. The distance between the trailer drawbar and the red guide line is now approximately 0.30 m.
- ▶ Couple up the trailer (▷ page 197).

Wide-angle function

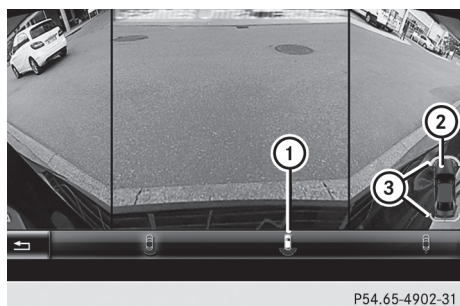

- ① Symbol for the wide-angle view function
- ② Own vehicle
- ③ Parking Assist PARKTRONIC warning displays

Select this view when you are driving out of an exit and the view of crossing traffic is restricted, for example.

ATTENTION ASSIST

General notes

ATTENTION ASSIST helps you during long, monotonous journeys such as on motorways and trunk roads. It is active in the 60 km/h to 200 km/h speed range. If ATTENTION ASSIST detects typical indicators of fatigue or increasing lapses in concentration on the part of the driver, it suggests taking a break.

Important safety notes

ATTENTION ASSIST is only an aid. It may not always detect fatigue or lapses in concentration until too late, or may not detect them at all. The system is not a substitute for a well-rested and attentive driver.

The functionality of ATTENTION ASSIST is restricted, and warnings may be delayed or not occur at all in the following situations:

- the length of the journey is less than approximately 30 minutes
- if the road condition is poor, e.g. if the surface is uneven or contains potholes
- in the event of strong crosswinds
- if you have adopted a sporty driving style with high cornering speeds or high rates of acceleration
- if you are predominantly driving at a speed below 60 km/h or above 200 km/h
- if the time has been set incorrectly
- in active driving situations, such as when you change lanes or change your speed

ATTENTION ASSIST is reset and starts assessing your tiredness again when you continue your journey if:

- you switch off the engine
- you take off your seat belt and open the driver's door, e.g. for a change of drivers or to take a break

Displaying the attention level

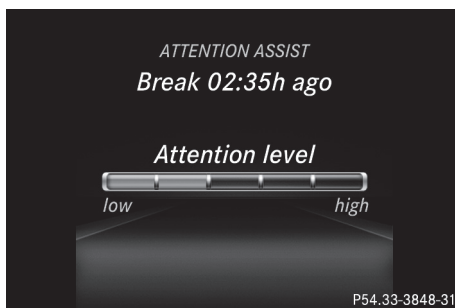

You can have current status information displayed in the assistance menu (▷ page 210) of the on-board computer.

- ▶ Select the assistance graphics display for ATTENTION ASSIST using the on-board computer (▷ page 210).

The following information is displayed:

- the length of the journey since the last break
- the attention level determined by ATTENTION ASSIST (**Attention level**), displayed in a bar display in five levels from high to low.
- if ATTENTION ASSIST is unable to calculate the attention level and cannot output a warning, the **System suspended** message appears. The bar display then changes the display, e.g. if you are driving at a speed below 60 km/h or above 200 km/h.

Activating ATTENTION ASSIST

- ▶ Activate ATTENTION ASSIST using the on-board computer (▷ page 211).
The system determines the attention level of the driver depending on the setting selected:

Standard selected: the sensitivity with which the system determines the attention level is set to normal.

Sensitive selected: the sensitivity is set higher. The attention level detected by ATTENTION ASSIST is adapted accordingly and the driver is warned earlier.

When ATTENTION ASSIST is deactivated, the  symbol appears in the multifunction display in the assistance graphic display.

When ATTENTION ASSIST has been deactivated, it is automatically reactivated after the engine has been switched off. The sensitivity selected corresponds to the last selection activated (standard/sensitive).

Warning on the multifunction display

If fatigue or increasing lapses in concentration are detected, a warning appears in the multifunction display: **ATTENTION ASSIST Take a break!**

In addition to the message shown on the multifunction display, you will then hear a warning tone.

- ▶ If necessary, take a break.
- ▶ Confirm the message by pressing the  button on the steering wheel.

On long journeys, take regular breaks that allow for adequate refreshment. If you do not take a break and ATTENTION ASSIST still detects increasing lapses in concentration, you will be warned again after 15 minutes at the earliest. This will happen only if ATTENTION ASSIST still

detects typical indicators of fatigue or increasing lapses in concentration.

Vehicles with multimedia system COMAND

Online: if a warning is output in the multifunction display, a service station search is performed in the multimedia system. You can select a service station and you will then be navigated to this service station. This function can be activated or deactivated in the multimedia system; see Digital Owner's Manual.

Traffic Sign Assist

General notes

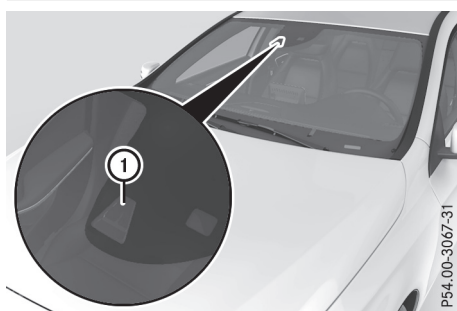

Traffic Sign Assist displays the maximum speed permitted and overtaking restrictions to the driver in the instrument cluster. Driving onto a section of road in the wrong direction triggers a warning. Traffic Sign Assist detects traffic signs with multifunction camera ① attached at the top of the windscreen. The data and general traffic regulations stored in the navigation system are also used to determine the current speed limit.

If a traffic sign that is relevant to your vehicle is passed, the display of the speed limits and overtaking restrictions is updated.

The display can also be updated without a visible traffic sign in the following situations:

- the vehicle changes roads (e.g. motorway exit or slip road)
- a village or town boundary that is stored in the digital map is passed
- the last traffic sign detected by the camera has not been repeated

If a sign indicating the end of a restriction (speed limit or overtaking restriction) is passed, the sign is displayed for five seconds. The currently applicable traffic regulation continues to be

shown in the assistance graphic display (▷ page 210).

The camera also detects traffic signs with a restriction indicated by an additional sign (e.g. in wet conditions).

The traffic signs are only displayed with the restriction if:

- the regulation must be observed with the restriction, or
- Traffic Sign Assist is unable to determine whether the restriction applies

If Traffic Sign Assist is unable to determine a maximum permitted speed from any of the available sources, no speed limit is displayed in the instrument cluster either.



Traffic Sign Assist is not available in all countries. In this case, display ① is shown in the multifunction display.

Important safety notes

Traffic Sign Assist is only an aid and is not always able to correctly display speed limits and overtaking restrictions. Traffic signs always have priority over the Traffic Sign Assist display.

The system may be either functionally impaired or temporarily unavailable in the following situations:

- Visibility is poor, e.g. due to snow, rain, fog or spray
- Glare, e.g. from the sun being low in the sky
- Dirt, ice or misting on the windscreen in the vicinity of the camera
- Traffic signs are hard to detect (dirt, ice, snow)
- Traffic signs are insufficiently lit at night

- Signs are ambiguous (e.g. traffic signs on construction sites or in adjacent lanes)
- Information in the digital street map of the navigation system is incorrect or out of date

Activating Traffic Sign Assist

If you have activated the Traffic Sign Assist display in the on-board computer, the traffic regulations (speed limits and overtaking restrictions) are displayed in the instrument cluster for five seconds in each case. The wrong-way warning and the traffic sign display for speed limits and overtaking restrictions remain active in the assistance graphic even when the display has been deactivated.

- ▶ Activate the Traffic Sign Assist display using the on-board computer (▷ page 210).

Instrument cluster display

Speed limit with unknown restriction

i The following illustrations are examples of vehicles with colour multifunction display. The illustrations of vehicles with black and white multifunction display differ from them.

i The unit for the speed limit (km/h or mph) depends on the country in which you are driving. It is generally shown neither on the traffic sign nor in the instrument cluster but must be taken into account when observing the maximum permitted speed.

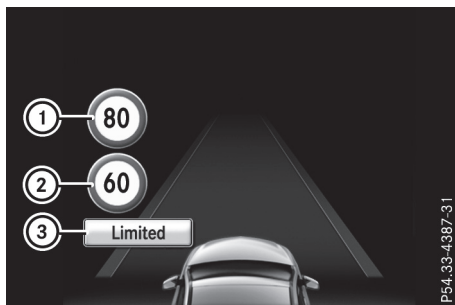

- ① Maximum permissible speed
- ② Maximum permissible speed for vehicles for which the restriction in the additional sign is relevant
- ③ Additional sign for unknown restriction

A maximum permissible speed of 80 km/h (80 mph) and a speed limit of 60 km/h (60 mph) with an unknown restriction apply.

No entry (wrong-way warning)



A warning message ① is displayed in the instrument cluster if Traffic Sign Assist detects that you are passing a “no entry” sign and you are driving in the wrong direction. You will then also hear a warning tone. You should immediately check your direction of travel in order to avoid danger to yourself and other road users.

Lane Tracking package

General notes

The Lane Tracking package consists of Blind Spot Assist (▷ page 193) and Lane Keeping Assist (▷ page 194).

Blind Spot Assist

General notes

Blind Spot Assist monitors the areas on either side of the vehicle that are not visible to the driver with two lateral, rear-facing radar sensors. A warning display in the exterior mirrors draws your attention to vehicles detected in the monitored area. If you then switch on the corresponding turn signal to change lanes, you will also receive a visual and audible warning.

Blind Spot Assist supports you from a speed of approximately 30 km/h.

Important safety notes

WARNING

Blind Spot Assist does not react to vehicles:

- overtaken too closely on the side, placing them in the blind spot area
- when the difference in the speed of approach and overtaking is too great

As a result, Blind Spot Assist cannot warn drivers in these situations. There is a risk of an accident.

Always pay careful attention to the traffic situation and maintain a safe distance at the side of the vehicle.

Blind Spot Assist is only an aid. It may fail to detect some vehicles and is not a substitute for attentive driving. Always ensure that there is sufficient distance to the side for other road users and obstacles.

Radar sensors

The radar sensors for Blind Spot Assist are integrated into the rear bumper. Make sure that the bumpers are free from dirt, ice or slush. The sensors must not be covered, e.g. by cycle racks or overhanging loads. Following a severe impact or in the event of damage to the bumpers, have the function of the radar sensors checked at a qualified specialist workshop. Blind Spot Assist may no longer work properly in such cases.

Monitoring range of the sensors

In particular, the detection of obstacles can be impaired in the following situations:

- dirt on the sensors or obscured sensors
- poor visibility, e.g. due to fog, heavy rain or snow
- a narrow vehicle travelling in front, e.g. a motorcycle or a bicycle
- very wide lanes
- narrow lanes
- vehicles not driving in the middle of their lane
- barriers or other road boundaries

Vehicles in the monitoring range are then not indicated.

Blind Spot Assist monitors an area up to 3.0 m behind your vehicle and directly next to your vehicle.

If the lanes are narrow, vehicles driving in the lane beyond the lane next to your vehicle may be indicated, especially if the vehicles are not driving in the middle of their lane. This may be the case if the vehicles are driving on the inner side of their lane.

Due to the nature of the system:

- warnings may be issued in error when driving close to crash barriers or similar solid boundaries
- warnings may be interrupted when you are driving alongside particularly long vehicles, such as lorries, for a prolonged time

Warning display

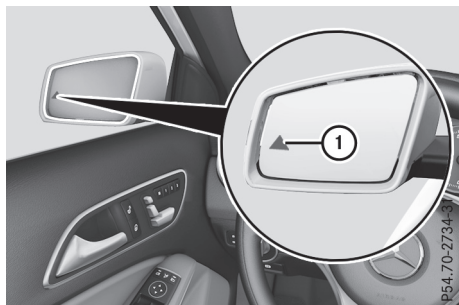

① Warning display

Blind Spot Assist is not active at speeds below approximately 30 km/h. Vehicles in the monitoring range are then not indicated.

If Blind Spot Assist is activated, indicator lamp ① in the exterior mirrors lights up yellow up to a speed of 30 km/h. At speeds above 30 km/h, the indicator lamp goes out and Blind Spot Assist is operational.

If a vehicle is detected within the monitoring range of Blind Spot Assist at speeds above 30 km/h, warning lamp ① on the corresponding side lights up red. This warning always occurs when a vehicle enters the blind spot monitoring range from behind or from the side. When you overtake a vehicle, the warning only occurs if the difference in speed is less than 12 km/h.

The yellow indicator lamp goes out if reverse gear is engaged. Blind Spot Assist is then deactivated.

The brightness of the indicator/warning lamps is adjusted automatically according to the ambient light.

Collision warning

If a vehicle is detected in the blind spot monitoring range and you switch on the corresponding turn signal, a double warning tone sounds. Red warning lamp ① flashes. If the turn signal remains on, detected vehicles are indicated by

the flashing of red warning lamp ①. There are no further warning tones.

Activating Blind Spot Assist

- ▶ Make sure that Blind Spot Assist is activated in the on-board computer (▷ page 211).
- ▶ Turn the key to position ② in the ignition lock.

Warning lamps ① in the exterior mirrors light up red for approximately 1.5 seconds and then turn yellow.

Towing a trailer

If you couple up a trailer, make sure that you have correctly established the electrical connection. This can be accomplished by checking the trailer lighting. Blind Spot Assist is then deactivated. The indicator lamps in the exterior mirrors light up yellow and the **Blind Spot Assist not available when towing a trailer** See Owner's Manual message appears in the multifunction display.

i You can deactivate the indicator lamps in the exterior mirrors.

To do so, you will need to deactivate Blind Spot Assist if:

- the key is in position ② in the ignition lock
- the engine is not running
- the electrical connection to the trailer has been established

Lane Keeping Assist

General notes

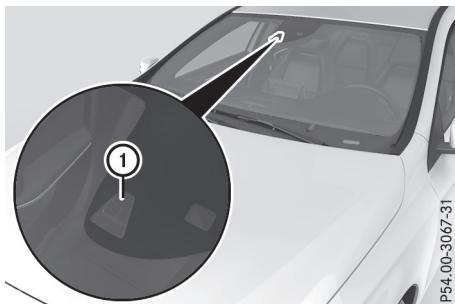

Lane Keeping Assist monitors the area in front of your vehicle by means of multifunction camera ① attached at the top of the windscreen. Lane Keeping Assist detects lane markings on

the road and can warn you before you leave your lane unintentionally.

This function is available in a speed range between 60 km/h and 200 km/h.

A warning may be given if a front wheel passes over a lane marking. It will warn you by means of intermittent vibration through the steering wheel for up to 1.5 seconds.

Important safety notes

WARNING

Lane Keeping Assist cannot always clearly detect lane markings.

In such cases, Lane Keeping Assist can:

- issue an unnecessary warning
- not issue a warning

There is a risk of an accident.

Always pay particular attention to the traffic situation and keep within the lane, especially if Lane Keeping Assist alerts you.

WARNING

The Lane Keeping Assist warning does not return the vehicle to the original lane. There is a risk of an accident.

Always steer, apply the brakes or accelerate the vehicle yourself, especially if Lane Keeping Assist alerts you.

If you fail to adapt your driving style, Lane Keeping Assist can neither reduce the risk of an accident nor override the laws of physics. Lane Keeping Assist cannot take into account road, weather or traffic conditions. Lane Keeping Assist is only an aid. You are responsible for the distance to the vehicle in front, for vehicle speed, for braking in good time and for staying in lane.

Lane Keeping Assist does not keep your vehicle in its lane.

The system may be impaired or may not function in the following situations:

- poor visibility, e.g. due to insufficient illumination of the road, or due to snow, rain, fog or spray
- glare, e.g. from oncoming traffic, the sun or reflection from other vehicles (e.g. if the road surface is wet)

- the windscreen is dirty, misted up, damaged or covered, for instance by a sticker, in the vicinity of the camera
- there are no lane markings, or several unclear lane markings for one lane are present, e.g. around construction sites
- the lane markings are worn away, dark or covered up, e.g. by dirt or snow
- the distance to the vehicle in front is too short and thus the lane markings cannot be detected
- the lane markings change quickly, e.g. lanes branch off, cross one another or merge
- the road is very narrow and winding
- there are highly variable shade conditions on the roadway

Activating Lane Keeping Assist

► Activate Lane Keeping Assist using the on-board computer; to do so, select **Standard** or **Adaptive** (▷ page 194).

If you drive at speeds above 60 km/h and lane markings are detected, the lane markings are shown in green in the assistance graphic (▷ page 210).

If **Standard** is selected, no warning vibration occurs if:

- you have switched on the turn signal. In this event, the warnings are suppressed for a certain period of time.
- a driving safety system such as ABS, BAS or ESP® intervenes.

When **Adaptive** is selected, no warning vibration occurs if:

- you have switched on the turn signal. In this case, the warnings are suppressed for a certain period of time.
- a driving safety system such as ABS, BAS or ESP® intervenes.
- you accelerate hard, e.g. kickdown.
- you brake hard.
- you steer actively, e.g. swerve to avoid an obstacle or change lane quickly.
- You cut the corner on a sharp bend.

To ensure that you are warned only when necessary and in good time if you cross the lane marking, the system detects certain conditions and warns you accordingly.

The warning vibration occurs earlier in the following situations if:

- you approach the outer lane marking on a bend
- the road has very wide lanes, e.g. a motorway
- the system detects solid lane markings

The warning vibration occurs later in the following situations if:

- the road has narrow lanes
- you cut the corner on a bend

Towing a trailer

Important safety notes

WARNING

You could lose control of the vehicle/trailer combination if it begins to swerve. The vehicle/trailer combination could even overturn. There is a risk of an accident.

On no account should you attempt to straighten out the vehicle/trailer combination by increasing speed. Decrease your speed and do not countersteer. Brake if necessary.

WARNING

If the maximum permissible load for a carrier system is exceeded, the carrier could come loose from the vehicle and endanger other road users. There is a risk of an accident and injury.

Never exceed the maximum permissible load when using a carrier.

! If you have a trailer tow hitch retrofitted, changes to the engine cooling system may be necessary, depending on the vehicle type.

If you have a trailer tow hitch retrofitted, observe the anchorage points on the chassis.

Retrofitting a trailer tow hitch is only permissible if a trailer load is specified in your vehicle documents. If this is not the case, then the vehicle is not approved for towing a trailer.

For more information, please contact a qualified specialist workshop.

Exceeding the maximum permissible nose-weight of the trailer drawbar on the ball coupling may cause damage to the following:

- your vehicle
- trailer
- ball coupling
- trailer tow hitch

The vehicle/trailer combination could become unstable.

The vehicle/trailer combination could also become unstable if the noseweight used is lower than the minimum permissible noseweight.

To avoid hazardous situations:

- make sure to check the noseweight before each journey
- the noseweight should be as close as possible to the maximum noseweight
- do not exceed the maximum permissible noseweight
- the noseweight must not be lower than the minimum permissible noseweight

Make sure that the following values are not exceeded:

- the permissible noseweight
- the permissible trailer load
- the permissible rear axle load of the towing vehicle
- the maximum permissible gross vehicle weight of both the towing vehicle and the trailer

The applicable permissible values, which must not be exceeded, can be found:

- in your vehicle documents
- on the identification plates of the trailer tow hitch and the trailer
- on the vehicle identification plate

If the values differ, the lowest value applies.

You will find the values approved by the manufacturer on the identification plates and for the towing vehicle under "Technical data"

(> page 341).

WARNING

If you release the ball coupling or it does not engage correctly when folding in, it will swing out. Within pivoting range of the ball coupling, there is an increased risk of an accident and injury.

Only release the ball coupling if the pivoting range is unobstructed. Always make sure that the ball coupling engages when folding in.

When reversing the towing vehicle, make sure there is nobody between the trailer and the vehicle.

Couple and uncouple the trailer carefully. If you do not couple the trailer to the towing vehicle correctly, the trailer could become detached.

When towing a trailer, your vehicle's handling characteristics will be different to when driving without a trailer.

The vehicle/trailer combination:

- is heavier
- is restricted in its acceleration and gradient-climbing capability
- has an increased braking distance
- is affected more by strong crosswinds
- demands more sensitive steering
- has a larger turning circle

This can impair the vehicle's handling characteristics. Adapt your driving style accordingly. Maintain a safe distance. Drive carefully.

When towing a trailer, always adjust your speed to the current road and weather conditions. Do not exceed the maximum permissible speed for your vehicle/trailer combination.

Notes on towing a trailer

General notes

Trailer towing is not possible on the following models:

- A 180 d BlueEFFICIENCY Edition
- A 250 Sport
- A 250 Sport 4MATIC
- Mercedes-AMG A 45 4MATIC

When towing a trailer, set the tyre pressure on the rear axle of the towing vehicle for a maximum load. Further information on the tyre pressure table in the fuel filler flap (▷ page 319).

Please note that when towing a trailer, the following driving systems have limited availability or are not available at all:

- Parking Assist PARKTRONIC (▷ page 178)
- Blind Spot Assist (▷ page 193)

The height of the ball coupling changes with the load of the vehicle. If necessary, use a trailer with a height-adjustable drawbar.

You will find fitting dimensions and loads under "Technical data" (▷ page 341).

Driving tips

Observe the information on ESP® trailer stabilisation (▷ page 72).

The maximum permissible speed for vehicle/trailer combinations depends on the type of trailer. Before beginning the journey, check the trailer's documents to see what the maximum permitted speed is. Observe the legally prescribed maximum speed in the relevant country.

For certain Mercedes-Benz vehicles, the maximum permissible rear axle load is increased when towing a trailer. See the "Technical data" section to find out whether this applies to your vehicle. If when towing, the rear axle load is increased even partly, the vehicle/trailer combination may not exceed a maximum speed of 100 km/h for reasons concerning the operating permit. This also applies in countries in which the permissible maximum speed for vehicle/trailer combinations is above 100 km/h.

When towing a trailer, your vehicle's handling characteristics will be different to when driving without a trailer and the vehicle will consume more fuel.

Shift to a lower gear in good time on long and steep downhill gradients. For vehicles with automatic transmission, you need to have selected manual drive program **M** (▷ page 152).

This also applies if you have activated cruise control, the speed limiter or Distance Pilot DISTRONIC.

This will use the braking effect of the engine, so less braking will be required to maintain the vehicle speed. This relieves the load on the brake system and prevents the brakes from overheating and wearing too quickly. If you need additional braking, depress the brake pedal repeatedly rather than continuously.

Briefly depressing the accelerator pedal on downhill gradients while the manual drive program **M** is temporarily activated (vehicles with automatic transmission); the automatic transmission may switch back to the last active automatic drive program **E** or **S**. The automatic transmission may shift to a higher gear. This can reduce the engine's braking effect.

Driving tips

- Maintain a greater distance to the vehicle in front than when driving without a trailer.
- Avoid braking abruptly. If possible, brake gently at first to allow the trailer to run on. Then, increase the braking force rapidly.
- The values given for gradient-climbing capabilities from a standstill refer to sea level. When driving in mountainous areas, note that the power output of the engine, and consequently the vehicle's gradient-climbing capability from a standstill, decrease with increasing altitude.

If the trailer swings from side to side:

- ▶ Do not accelerate under any circumstances
- ▶ Do not countersteer
- ▶ Brake if necessary

Folding out the ball coupling

Folding out the ball coupling

WARNING

If the ball coupling is not correctly engaged, the trailer can detach. There is a risk of an accident.

Always engage the ball coupling as described.

WARNING

If you release the ball coupling or it does not engage correctly when folding in, it will swing out. Within pivoting range of the ball coupling, there is an increased risk of an accident and injury.

Only release the ball coupling if the pivoting range is unobstructed. Always make sure that the ball coupling engages when folding in.

Before you can tow a trailer with your vehicle, you must fold out the ball coupling.

The release wheel is located behind the left-hand side trim panel in the luggage compartment.

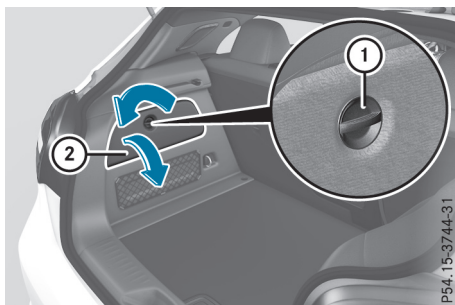

- ▶ **To open the cover:** turn handle ① anti-clockwise, the fold down and remove cover ②.

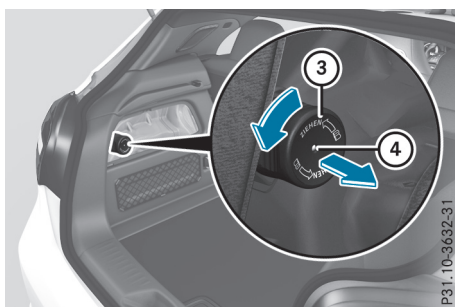

- ▶ Pull out release wheel ③.
- ▶ Turn release wheel ③ anti-clockwise as far as it will go. The ball coupling disengages and folds out behind the rear bumper. Indicator lamp ④ flashes.

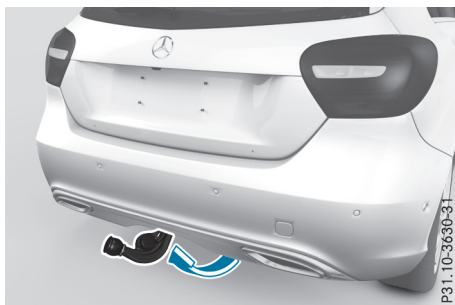

- ▶ Pull the ball coupling in the direction of the arrow until it engages in a vertical position. The indicator lamp on the release wheel goes out. The power socket folds down automatically.

The multifunction display shows the **Check trailer hitch lock** display message until the ball coupling is engaged.

- ▶ Remove the protective cap from the ball coupling and store it in a safe place.
- ▶ Make sure that the ball of the ball coupling is clean and that it is either greased or dry (grease free), depending on the instructions for the trailer.

Folding in the ball coupling

WARNING

If you release the ball coupling or it does not engage correctly when folding in, it will swing out. Within pivoting range of the ball coupling, there is an increased risk of an accident and injury.

Only release the ball coupling if the pivoting range is unobstructed. Always make sure that the ball coupling engages when folding in.

- i** Fold the ball coupling in if you are not using the trailer tow hitch.
- ▶ Make sure that the vehicle is stationary and the trailer cables are disconnected.
- ▶ Place the protective cap on the ball coupling.
- i** The release wheel is located behind the left-hand side trim panel in the luggage compartment.
- ▶ **To open the cover:** turn handle ① anti-clockwise, then fold down and remove cover ②.
- ▶ Pull out release wheel ③.
- ▶ Turn release wheel ③ anti-clockwise as far as it will go.
The ball coupling disengages and folds out behind the rear bumper. Indicator lamp ④ flashes.
- ▶ Press the ball coupling until it engages audibly behind the bumper.
The indicator lamp on the release knob and the message in the multifunction display go out.

Coupling up a trailer

- ▶ Make sure that the transmission is in position **P**.
- ▶ Apply the electric parking brake.
- ▶ Position the trailer on a level surface behind the vehicle.
- ▶ Couple up the trailer.
- ▶ Establish the electrical connection between the vehicle and the trailer.
- ▶ Check that the trailer lighting system is working.

A connected trailer is only detected when the electrical connection is established correctly and when the lighting system is working properly. The function of other systems, such as ESP® or PARKTRONIC also depends on this.

Uncoupling a trailer

WARNING

If you uncouple a trailer with an engaged overrun brake, you could trap your hand between the vehicle and the trailer drawbar. This poses a risk of injury.

Do not uncouple a trailer with an engaged overrun brake.

- !** Do not disconnect a trailer with an engaged overrun brake. Otherwise, your vehicle could be damaged by the rebounding of the overrun brake.
- !** Remove the installed adapter cable before folding in the ball coupling. Otherwise, damage may occur to the rear bumper and the adapter cable.
- ▶ Make sure that the transmission is in position **P**.
- ▶ Apply the electric parking brake.
- ▶ Secure the trailer against rolling away.
- ▶ Remove the trailer cable and decouple the trailer.

Trailer power supply

- !** You can connect accessories to the permanent power supply up to a maximum of 240 W.

You cannot charge a trailer battery using the power supply.

When it leaves the factory, your vehicle's trailer socket is equipped with a permanent power supply and a power supply that is switched on via the ignition lock.

The permanent power supply is supplied via trailer socket pin 9.

The power supply that is switched on via the ignition lock is supplied via trailer socket pin 10.

The trailer's permanent power supply is switched off in the event of low on-board voltage and after six hours at the latest.

You can find more information about installing the trailer electrics at a qualified specialist workshop.

► **To switch the connected power supply on or off:** turn the key to position **2** or **0** in the ignition lock (► page 135).

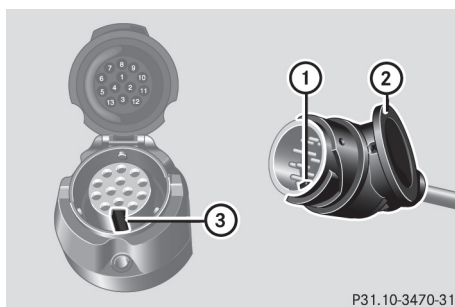

P31.10-3470-31

- Open the socket cover.
- Insert the plug connector with lug **1** into groove **3** on the socket.
- Turn bayonet connection **2** clockwise to the stop.
- Let the cover engage.
- If you are using an adapter cable, secure the cable to the trailer with cable ties.

Failure check for LEDs

If LED lamps are fitted in the trailer, a malfunction message may appear in the multifunction display even if there is no fault. The reason for the error message may be that the current has fallen below the minimum of 50 mA.

To ensure reliable operation of the failure indicator, each LED chain in the trailer lighting must be guaranteed a minimum current of 50 mA.

Trailer with 7-pin connector

General notes

Trailer with 7-pin connector: you can connect to the 13-pin socket on the ball coupling using an adapter or, if necessary, an adapter cable. Both can be obtained at a qualified specialist workshop.

Fitting the adapter

- ❗ Make sure that there is sufficient cable play so that the cable cannot become detached when cornering.
- ❗ Remove the installed adapter cable before folding in the ball coupling. Otherwise, damage may occur to the rear bumper and the adapter cable.

Important safety notes

WARNING

If you operate information and communication equipment integrated in the vehicle when driving, you could be distracted from the traffic situation. This could also cause you to lose control of the vehicle. There is a risk of an accident.

Only operate this equipment when the traffic situation permits. If you cannot be sure of this, stop the vehicle paying attention to road and traffic conditions and operate the equipment with the vehicle stationary.

You must observe the legal requirements for the country in which you are currently driving when operating the on-board computer.

WARNING

If the instrument cluster has failed or malfunctioned, you may not recognise function restrictions relevant to safety. The operating safety of your vehicle may be impaired. There is a risk of an accident.

Drive on carefully. Have the vehicle checked at a qualified specialist workshop immediately.

The on-board computer shows only display messages or warnings from certain systems on the multifunction display. You should therefore make sure your vehicle is operating safely at all times.

If the operating safety of your vehicle is impaired, park the vehicle safely as soon as possible. Contact a qualified specialist workshop.

For an overview, see the instrument cluster illustration (▷ page 33).

Displays and operation



Instrument cluster lighting

The light sensor in the instrument cluster automatically controls the brightness of the multifunction display. In daylight, the displays in the instrument cluster are not illuminated.

The lighting in the instrument cluster, in the displays and the controls in the vehicle interior can be adjusted using the brightness control knob.

The brightness control knob is located on the bottom left of the instrument cluster (▷ page 33).

▶ Turn the brightness control knob clockwise or anti-clockwise.

If the light switch is set to the ,  or  position, the brightness is dependent upon the brightness of the ambient light.

Speedometer with segments

The speedometer is divided into segments on vehicles with Distance Pilot DISTRONIC.

The segments in the speedometer indicate which speed range is available.

- Variable speed limiter is activated (▷ page 166):

The segments light up from the start of the scale to the selected speed limitation.

- Distance Pilot DISTRONIC is activated (▷ page 168):

One or two segments in the stored speed range light up.

- Distance Pilot DISTRONIC detects a vehicle in front moving more slowly than the stored speed:

The segments between the speed of the vehicle in front and the stored speed light up.

Rev counter

 Do not drive in the overrevving range. Doing so will damage the engine.

The red band in the rev counter indicates the engine's overrevving range.

The engine is limited within a range to protect the engine when the red band is reached.

Outside temperature display

You should pay special attention to road conditions when temperatures are around freezing point.

Bear in mind that the outside temperature display indicates the measured air temperature and not the road surface temperature.

The outside temperature display is in the multifunction display (▷ page 204).

There is a short delay before a change in outside temperature appears in the multifunction display.

Coolant temperature display

WARNING

If you open the bonnet while the engine is overheating or while there is a fire in the engine compartment, you could come into contact with hot gases or other leaking service products. There is a danger of injury.

Allow an overheating engine to cool down before opening the bonnet. If there is a fire in the engine compartment, leave the bonnet closed and notify the fire brigade.

The coolant temperature gauge is in the instrument cluster on the right-hand side (▷ page 33). Under normal operating conditions and with the correct coolant level, the coolant temperature may rise to 120 °C.

At high outside temperatures and when driving in mountainous terrain, the coolant temperature may rise to the end of the scale.

Operating the on-board computer

Overview

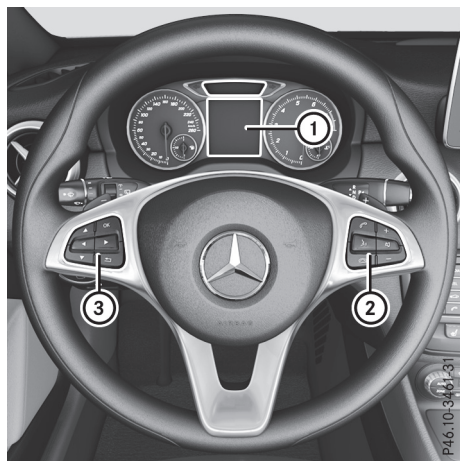









- ① Multifunction display
- ② Right control panel
- ③ Left control panel





► **To activate the on-board computer:** turn the key to position **1** in the ignition lock.



You can control the multifunction display and the settings on the on-board computer using the buttons on the multifunction steering wheel.

Left control panel

 	<ul style="list-style-type: none"> • Calls up the menu and menu bar
 	<p>Press briefly:</p> <ul style="list-style-type: none"> • Scrolls through lists • Selects a submenu or function • In the Audio menu: selects the previous or next station, when the preset list or station list is active, or an audio track or video scene • In the Tel (telephone) menu: switches to the phone book and selects a name or telephone number
 	<p>Press and hold:</p> <ul style="list-style-type: none"> • In the Audio menu: selects a preset list or a station list in the desired frequency range, or an audio track or video scene using rapid scrolling • In the Tel (Telephone) menu: starts rapid scrolling if the phone book is open
	<ul style="list-style-type: none"> • Confirms the selection or display message • In the Tel (Telephone) menu: switches to the telephone book and starts dialling the selected number
	<p>Press briefly:</p> <ul style="list-style-type: none"> • Back • Vehicles with Audio 20: switches off voice-operated control for navigation (see the manufacturer's operating instructions) • Vehicles with COMAND Online: switches off LINGUATRONIC (see the separate operating instructions) • Hides display messages or calls up the last Trip menu function used • Exits the telephone book/redial memory
	<p>Press and hold:</p> <ul style="list-style-type: none"> • Calls up the standard display in the Trip menu

Right control panel

	<ul style="list-style-type: none"> • Vehicles with Audio 20: Switches on voice-operated control for navigation (see the manufacturer's operating instructions) • Vehicles with COMAND Online: Switches off LINGUATRONIC (see the separate operating instructions)
	<ul style="list-style-type: none"> • Switches sound on/off
 	<ul style="list-style-type: none"> • Adjusts the volume

	<ul style="list-style-type: none"> • Rejects or ends a call • Exits the telephone book/redial memory
	<ul style="list-style-type: none"> • Makes or accepts a call • Switches to the redial memory

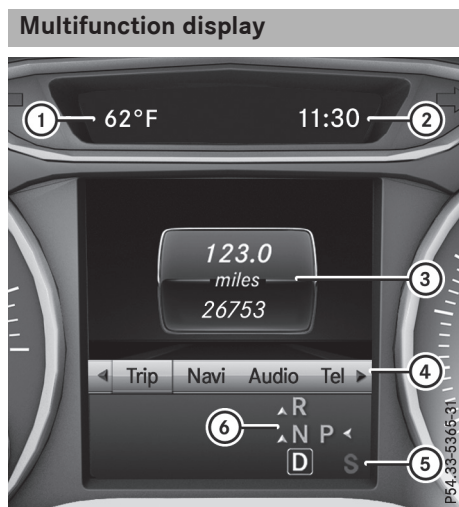

- ① Permanent display: outside temperature or speed (▷ page 212)
- ② Time
- ③ Text field
- ④ Menu bar
- ⑤ Drive program (▷ page 146)
- ⑥ Transmission position (▷ page 148)

Vehicles with manual transmission: the indicators in the lower part of the multifunction display differ from those shown here.

For Mercedes-AMG vehicles, the indicators in the lower and upper part of the multifunction display differ from those shown here.







▶ **To display menu bar** ④: press the ◀ or ▶ button on the steering wheel.

If you do not press any other button, menu bar ④ is faded out after a few seconds.

Text field ③ shows the selected menu or submenu as well as display messages.

- i** Set the time using the multimedia system (see the Digital Owner's Manual).

The following messages may appear in the multifunction display:

-  Gearshift recommendation for manual transmission (▷ page 145) or for automatic transmission (manual gearshifting) (▷ page 152)
-  Parking Pilot (▷ page 181)
-  Cruise control (▷ page 164)
-  Limiter (▷ page 166)
-  Adaptive Highbeam Assist (▷ page 110)
-  ECO start/stop function (▷ page 139)
-  HOLD function (▷ page 174)
- **120 km/h!** Maximum permissible speed exceeded (only for certain countries)

Menus and submenus

Menu overview

Using the ◀ or ▶ button on the steering wheel, open the menu bar.

Operating the on-board computer (▷ page 202). Depending on the equipment fitted in the vehicle, you can call up the following menus:

- **Trip** menu (▷ page 205)
- **Navi** menu (navigation instructions) (▷ page 206)
- **Audio** menu (▷ page 207)
- **Tel** menu (telephone) (▷ page 208)
- **Assist.** menu (assistance) (▷ page 210)
- **Serv.** menu (▷ page 211)
- **Settings** menu (settings) (▷ page 212)
- **AMG** menu (Mercedes-AMG vehicles) (▷ page 215)

The displays for the **Audio**, **Navi** and **Tel** menus may differ slightly to those in your vehicle.

The examples given in this Owner's Manual apply to vehicles equipped with COMAND Online.

Trip menu

Standard display



- ▶ Press and hold the button on the steering wheel until the **Trip** menu with trip meter ① and total distance recorder ② appears.

Trip computer "From start" or "From reset"

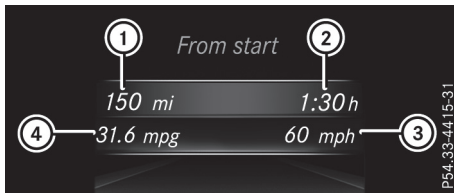

- ① Distance
- ② Driving time
- ③ Average speed
- ④ Average fuel consumption
- ▶ Press the or button on the steering wheel to select the **Trip** menu.
- ▶ Press the or button to select **From start** or **From reset**.

The values in the **From start** submenu are calculated from the start of a journey whilst the values in the **From reset** submenu are calculated from the last time the submenu was reset (▷ page 206).

In the following cases, the trip computer is automatically reset **From start**:

- the ignition has been switched off for more than four hours
- 999 hours have been exceeded.
- 9,999 kilometres have been exceeded.

When 9,999 hours or 99,999 kilometres have been exceeded, the trip computer is automatically reset **From reset**.

ECO display

The ECO display is not available in Mercedes-AMG vehicles.

- ▶ Press the or button on the steering wheel to select the **Trip** menu.
- ▶ Press the or button to select **ECO DISPLAY**.

If the ignition remains switched off for longer than four hours, the ECO display will be automatically reset.

Further information on the ECO display (▷ page 160).

Displaying the range and current fuel consumption

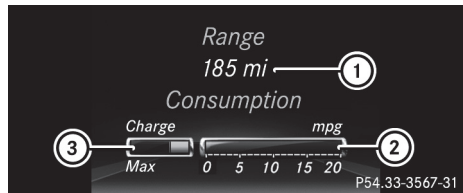

Mercedes-AMG vehicles: the menu only displays range ①.

- ▶ Press the or button on the steering wheel to select the **Trip** menu.
- ▶ Press or to select the display with approximate range ① and current fuel consumption ②.

Approximate range ① that can be covered is calculated according to your current driving style and the amount of fuel in the tank. If there is only a small amount of fuel left in the fuel tank, a vehicle being refuelled appears instead of approximate range ①.

Recuperation display ③ shows you if energy has been recuperated from the kinetic energy in overrun mode and saved in the battery. Recuperation display ③ depends on the engine installed and is therefore not available in all vehicles.

Digital speedometer

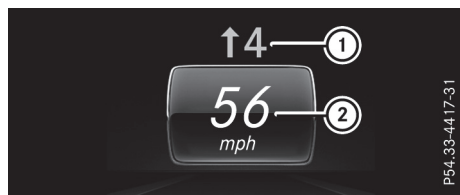

- ▶ Press the or button on the steering wheel to select the **Trip** menu.
- ▶ Press the or button to select digital speedometer ②. Gearshift recommendation ① may also be displayed.

Observe the information on gearshift recommendation ① for manual transmission (▷ page 145) or for automatic transmission (shifting manually) (▷ page 152).

Mercedes-AMG vehicles: a gearshift recommendation is shown in the status bar of the multifunction display and not in the digital speedometer display.

Resetting values

- ▶ Press the or button on the steering wheel to select the **Trip** menu.
- ▶ Press the or button to select the function that you wish to reset.
- ▶ Press to confirm.
- ▶ Press to select **Yes** and press to confirm.

You can reset the values of the following functions:

- Trip meter
- "From start" trip computer
- "From reset" trip computer
- ECO display

If you reset the values in the "ECO display", the values in the "From start" trip computer are also reset. If you reset the values in the "From start" trip computer, the values in the "ECO display" are also reset.

Navigation menu

Displaying navigation instructions

In the **Navi** menu, the multifunction display shows the navigation instructions.

You can find further information on navigation in the Digital Owner's Manual for the multimedia system.

- ▶ Switch on the multimedia system (see the Digital Owner's Manual)
- ▶ Press the or button on the steering wheel to select the **Navi** menu.

Route guidance not active



- ① Direction of travel
- ② Current road

Route guidance active

No change of direction announced



- ① Distance to the destination
- ② Distance to the next change of direction
- ③ Current road
- ④ Symbol indicating "follow the road's course"

Change of direction without lane recommendation



- ① Road to which the change of direction leads
- ② Distance to change of direction and visual distance display
- ③ Change-of-direction symbol

When a change of direction is to be made, you will see symbol ③ for the change of direction and distance graphic ②. This shortens towards the top of the display as you approach the point of the announced change of direction. The change of direction starts once the distance display reaches zero.

Change of direction announced with a lane recommendation



- ① Road to which the change of direction leads
- ② Distance to change of direction and visual distance display
- ③ Lanes not recommended
- ④ Recommended lane and new lane during a change of direction
- ⑤ Change-of-direction symbol

On multi-lane roads, new lane recommendations can be displayed for the next change of direction if the digital map supports this data. During the change of direction, new lanes may be added.

Lane not recommended ③: you will not be able to complete the next change of direction if you stay in this lane.

Recommended lane and new lane during a change of direction ④: in this lane you will be able to complete the next two changes of direction without changing lane.

Other status indicators of the navigation system



The navigation system displays additional information and the vehicle status.

Possible displays:

- **New route... or Calculating route...**
A new route is calculated.
- **Road not mapped**
The vehicle position is inside the area of the digital map but the road is not recognised, e.g. new roads, car parks or private land.
- **No route**
No route could be calculated to the selected destination.
- 
You have reached the destination or an intermediate destination.





Audio menu

Selecting a radio station





- ① Active station list
- ② Station with preset position

The multifunction display shows the station ② with station frequency or station name. The preset position is displayed along with the station ② only if this has been stored.

- ▶ Switch on the multimedia system and select radio (see the Digital Owner's Manual).
- ▶ Press the  or  button on the steering wheel to select the **Audio** menu.
- ▶ **To select a preset list or station list:** press and briefly hold the  or  button until

the preset list or station list in the desired frequency range is shown.









- ▶ **To select a station:** briefly press  or .
- ❗ **DAB radio mode (Digital Audio Broadcasting)** is an optimised digital transmission standard designed for the mobile reception of radio transmissions.

Operating the audio player or audio media



① Current track

Audio files from various audio players or media can be played, depending on the equipment fitted in the vehicle.







- ▶ Switch on the multimedia system and switch on CD or MP3 mode (see the Digital Owner's Manual).
- ▶ Press the  or  button on the steering wheel to select the **Audio** menu.
- ▶ **To select the next/previous track:** briefly press the  or  button.
- ▶ **To select a track from the track list (rapid scrolling):** press and hold the  or  button until the desired track appears. If you press and hold the  or  button, the rapid scrolling speed is increased. Not all audio players or media support this function.

If track information is saved on the audio player or media, the multifunction display will show the number and title of the track.

Operating the DVD-Video



Only for vehicles with COMAND Online: you can use the **Audio** menu to play video DVDs.







- ▶ Switch on COMAND Online and select DVD-Video (see the Digital Owner's Manual).
- ▶ Press the  or  button on the steering wheel to select the **Audio** menu.
- ▶ **To select the next or previous scene:** briefly press the  or  button.
- ▶ **To select a scene from the scene list (rapid scrolling):** press and hold the  or  button until desired scene ① appears.

Operating the TV



Only for vehicles with COMAND Online: you can use the **Audio** menu to select a TV station.

The preset position is displayed along with the channel ① only if this has been stored.

- ▶ Switch on COMAND Online and select TV (see the Digital Owner's Manual).
- ▶ Press the  or  button on the steering wheel to select the **Audio** menu.
- ▶ **To select a saved channel:** briefly press the  or  button.
- ▶ **To select a channel from the channel list:** press and briefly hold the  or  button.

- ❗ You can store TV channels in COMAND Online (see the Digital Owner's Manual).

Telephone menu

Introduction

WARNING

If you operate information and communication equipment integrated in the vehicle when driving, you could be distracted from the traffic situation. This could also cause you to lose



control of the vehicle. There is a risk of an accident.

Only operate this equipment when the traffic situation permits. If you cannot be sure of this, stop the vehicle paying attention to road and traffic conditions and operate the equipment with the vehicle stationary.

When using the phone, you must observe the legal requirements for the country in which you are currently driving.

- ▶ Switch on the mobile phone (see the manufacturer's operating instructions).
- ▶ Switch on the multimedia system (see the Digital Owner's Manual)
- ▶ Insert the mobile phone into the bracket (▷ page 281).

or

- ▶ Establish a Bluetooth® connection to the multimedia system (see Digital Owner's Manual).
- ▶ Establish a Bluetooth® connection to the multimedia system (see Digital Owner's Manual).
- ▶ Press the  or  button on the steering wheel to select the **TeI** menu.

You will see one of the following display messages on the multifunction display:

- **Telephone ready** or the name of the network provider: the mobile phone has found a network and is ready to receive.
- **Telephone No service**: there is no network available or the mobile phone is searching for a network.

i You can obtain further information on suitable mobile phones and connecting mobile phones via Bluetooth®:

- at any Mercedes-Benz Service Centre
- on the internet at <http://www.mercedes-benz.com/connect>

Accepting a call

If someone calls you when you are in the **TeI** menu, a display message appears in the multifunction display.

You can accept a call at any time, even if you are not in the **TeI** menu.







- ▶ Press the  button on the steering wheel to accept an incoming call.

Rejecting or ending a call



You can reject or end a call any time even if you are not in the **TeI** menu.

- ▶ Press the  button on the steering wheel to reject or end an incoming call.

Selecting an entry in the phone book

- ▶ Press the  or  button on the steering wheel to select the **TeI** menu.
- ▶ Press the ,  or  button to switch to the phone book.
- ▶ Authorise access to the phone book on the phone.
- ▶ Press the  or  button to select the desired name.



or





- ▶ **To begin rapid scrolling:** press and hold the  or  button for longer than one second.

Rapid scrolling stops when you release the button or reach the end of the list.



- ▶ **If only one telephone number is stored for a name:** press the  or  button to start dialling.

or

- ▶ **If there is more than one number for a particular name:** press the  or  button to display the numbers.





- ▶ Press the  or  button to select the number you want to dial.
- ▶ Press the  or  button to start dialling.

or

- ▶ **If you do not want to make the call:** press the  or  button.



Redialling

The on-board computer saves the last names or numbers dialled in the redial memory.

- ▶ Press the  or  button on the steering wheel to select the **TeI** menu.
- ▶ Press the  button to switch to the redial memory.
- ▶ Press the  or  button to select the desired name or number.

- ▶ Press the  or  button to start dialling.

or

- ▶ **If you do not want to make the call:** press the  or  button.

Assistance menu

Introduction



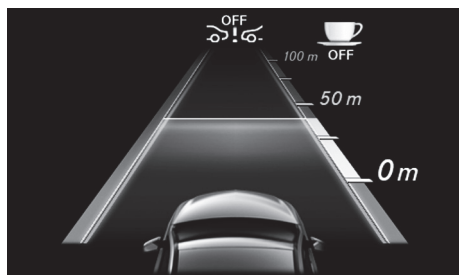

Depending on the equipment fitted in the vehicle, you have the following options in the **Assist.** menu:

- Showing the assistance graphic (▷ page 210)
- Activating/deactivating the Traffic Sign Assist message function (▷ page 210)
- Deactivating/activating ESP® (except Mercedes-AMG vehicles) (▷ page 210)
- Activating/deactivating Active Brake Assist (▷ page 211)
- Activating/deactivating ATTENTION ASSIST (▷ page 211)
- Activating/deactivating Blind Spot Assist (▷ page 211)
- Activating/deactivating Lane Keeping Assist (▷ page 211)

Showing the assistant display









P54.33-3192-31

- ▶ Press the  or  button on the steering wheel to select the **Assist.** menu.
- ▶ Press  or  to select **Assistant display.**
- ▶ Press  to confirm.
The assistant display shows you the status of and/or information from the following driving systems or driving safety systems:

- Traffic Sign Assist (▷ page 191)
 - Distance Pilot DISTRONIC (▷ page 168)
 - Active Brake Assist (▷ page 66)
 - ATTENTION ASSIST (▷ page 190)
 - Lane Keeping Assist (▷ page 194)
- ▶ Press  to display the ATTENTION ASSIST assessment.

Traffic Sign Assist

In the **Traffic Sign Assist** menu, you can switch the Traffic Sign Assist message function on or off. When the message function is activated, detected traffic signs and information appear in the multifunction display for five seconds.

- ▶ Press the  or  button on the steering wheel to select the **Assist.** menu.
- ▶ Press the  or  button to select **Traffic Sign Assist.**
- ▶ Press  to confirm.
The current selection appears.
- ▶ **To activate/deactivate the message function:** press  again.

Further information about Traffic Sign Assist (▷ page 191).

Activating/deactivating ESP®

Observe the important safety notes on ESP® (▷ page 69).

WARNING

If you deactivate ESP®, ESP® no longer stabilises the vehicle. There is an increased risk of skidding and an accident.

Only deactivate ESP® in the situations described in the following.



It may be best to deactivate ESP® in the following situations:

- when using snow chains
- in deep snow
- on sand or gravel

Deactivating/activating ESP® on Mercedes-AMG vehicles (▷ page 71).

For further information about ESP®, see (▷ page 69).

- ▶ Start the engine.
- ▶ Press the ◀ or ▶ button on the steering wheel to select the **Assist.** menu.
- ▶ Press ▲ or ▼ to select **ESP.**
- ▶ Press **OK** to confirm.
The current selection appears.
- ▶ **To activate/deactivate:** press **OK** again.
ESP® is deactivated if the  warning lamp in the instrument cluster lights up continuously when the engine is running.

If the  and  warning lamps light up continuously, ESP® is not available due to a malfunction.

Observe the information on warning lamps (▷ page 253).

Observe the information on display messages (▷ page 219).

Activating/deactivating Active Brake Assist

- ▶ Press the ◀ or ▶ button on the steering wheel to select the **Assist.** menu.
- ▶ Press the ▲ or ▼ button to select **Brake Assist.**
- ▶ Press **OK** to confirm.
The current selection appears.
- ▶ **To activate/deactivate:** press **OK** again.
When Active Brake Assist is deactivated, the  symbol appears in the multifunction display in the assistance graphic display.

Further information on Active Brake Assist (▷ page 66).

Activating/deactivating ATTENTION ASSIST

- ▶ Press the ◀ or ▶ button on the steering wheel to select the **Assist.** menu.
- ▶ Press the ▲ or ▼ button to select **Attention Assist.**
- ▶ Press **OK** to confirm.
The current selection appears.
- ▶ Press **OK** to confirm.
- ▶ Press the ▼ or ▲ button to set **Off**, **Standard** or **Sensitive.**
- ▶ Press the **OK** button to save the setting.
When ATTENTION ASSIST is deactivated, the  symbol appears in the multifunction display in the assistance graphic display.

For further information about ATTENTION ASSIST, see (▷ page 190).

Activating/deactivating Blind Spot Assist

- ▶ Press the ◀ or ▶ button on the steering wheel to select the **Assist.** menu.
- ▶ Press the ▲ or ▼ button to select **Blind Spot Assist.**
- ▶ Press **OK** to confirm.
The current selection appears.
- ▶ **To activate/deactivate:** press **OK** again.

Further information about Blind Spot Assist (▷ page 193).

Activating/deactivating Lane Keeping Assist

- ▶ Press the ◀ or ▶ button on the steering wheel to select the **Assist.** menu.
- ▶ Press the ▲ or ▼ button to select **Lane Keeping Assist.**
- ▶ Press **OK** to confirm.
The current selection appears.
- ▶ Press **OK** again to confirm.
- ▶ Press the ▼ or ▲ button to set **Off**, **Standard** or **Adaptive.**
- ▶ Press the **OK** button to save the setting.
When Lane Keeping Assist is activated, the multifunction display shows the lane markings as bright lines in the assistance graphic.

For further information about Lane Keeping Assist, see (▷ page 194).

Service menu

Depending on the equipment fitted in the vehicle, you have the following options in the **Serv.** menu:

- Calling up display messages in the message memory (▷ page 218)
- Restarting the tyre pressure loss warning system (▷ page 321)
- Calling up the service due date (▷ page 289)

Settings menu

Introduction

Depending on the equipment fitted in the vehicle, in the **Settings** menu you have the following options:

- Changing the instrument cluster settings
- Changing the light settings
- Changing the vehicle settings
- Changing the heating settings
- Changing the convenience settings
- Restoring the factory settings

Instrument cluster

Selecting the unit of measurement for distance

The **Display unit Speed-/odometer**: function allows you to choose whether certain displays appear in kilometres or miles in the multifunction display.

- ▶ Press the or button on the steering wheel to select the **Settings** menu.
- ▶ Press the or button to select the **Instrument cluster** submenu.
- ▶ Press **OK** to confirm.
- ▶ Press the or button to select the **Display unit Speed-/odometer** function. You will see the selected setting: **km** or **miles**.
- ▶ Press the **OK** button to save the setting.

The selected unit of measurement for distance applies to the following:

- digital speedometer in the **Trip** menu
- total distance recorder and the trip meter
- trip computer
- current fuel consumption and approximate range
- navigation instructions in the **Navi** menu
- cruise control
- speed limiter
- Distance Pilot DISTRONIC
- ASSYST PLUS service interval display

Switching the additional speedometer on/off

United Kingdom: this function is unavailable. If the additional speedometer is switched on, the speed is shown in the status bar of the mul-

tifunction display instead of the outside temperature.

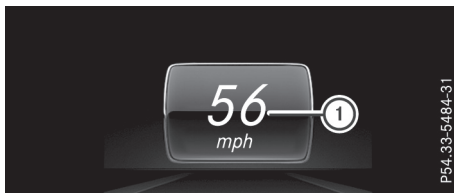

The speed display ① is an alternative to your speedometer.

- ▶ Press the or button on the steering wheel to select the **Settings** menu.
- ▶ Press the or button to select the **Instrument cluster** submenu.
- ▶ Press **OK** to confirm.
- ▶ Press the or button to select the **Dig. speedo [mph]** function. You will see the selected setting: **on** or **off**.
- ▶ Press **OK** to save the setting.

Selecting permanent display

United Kingdom: this function is unavailable.

The **Permanent display**: function allows you to choose whether the multifunction display always shows the outside temperature or the speed.

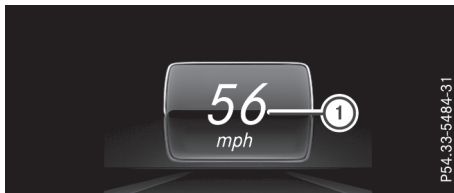

The speed display ① is an alternative to your speedometer.

- ▶ Press the or button on the steering wheel to select the **Settings** menu.
- ▶ Press the or button to select the **Instrument cluster** submenu.
- ▶ Press **OK** to confirm.
- ▶ Press the or button to select the **Permanent display**: function. The current setting, **outside temperature** or **Dig. speedo [mph]**:, appears.
- ▶ Press the **OK** button to save the setting.

Lights

Switching the daytime driving lights on/off

The **Daytime driving lights** function can only be switched on with the engine turned off.

- ▶ Press the or button on the steering wheel to select the **Settings** menu.
- ▶ Press the or button to select the **Lights** submenu.
- ▶ Press to confirm.
- ▶ Press the or button to select the **Daytime driving lights** function. If the **Daytime driving lights** function has been switched on, the cone of light and the symbol in the multifunction display are shown in orange.
- ▶ Press the button to save the setting.

Further information on daytime driving lights (▷ page 107).

Vehicle

Setting the permanent speed limiter

You can set the permanent limiter using the **Limit speed (winter tyres):** function.

- ▶ Press the or button on the steering wheel to select the **Settings** menu.
- ▶ Press the or button to select the **Vehicle** submenu.
- ▶ Press to confirm.
- ▶ Press or to select the **Limit speed (winter tyres):** function. You will see the current setting.
- ▶ Press to confirm.
- ▶ Press the or button to adjust the permanent speed limiter in increments of ten (**160 km/h to 240 km/h**). The **Off** setting switches the permanent speed limiter off.
- ▶ Press the button to store the entry.

Further information on the permanent speed limiter (▷ page 168).

Activating/deactivating the automatic locking feature

- ▶ Press the or button on the steering wheel to select the **Settings** menu.
- ▶ Press the or button to select the **Vehicle** submenu.

- ▶ Press to confirm.
- ▶ Press the or button to select the **Automatic door locks** function. If the **Automatic door locks** function is switched on, the multifunction display shows the vehicle's doors in orange.
- ▶ Press to save the setting.

If you activate the **Automatic door locks** function, the vehicle is centrally locked above a speed of around 15 km/h.

For further information on the automatic locking feature; see (▷ page 85).

Activating/deactivating the acoustic locking confirmation

If you switch on the **Acoustic Lock** function, an acoustic signal sounds when you lock the vehicle.

- ▶ Press the or button on the steering wheel to select the **Settings** menu.
- ▶ Press the or button to select the **Vehicle** submenu.
- ▶ Press to confirm.
- ▶ Press the or button to select the **Acoustic Lock** function. If the **Acoustic Lock** function is activated, the symbol in the multifunction display lights up orange.
- ▶ Press the button to save the setting.

Heating

Auxiliary heating departure time

DANGER

If the exhaust pipe is blocked or sufficient ventilation is not possible, toxic exhaust fumes can enter the vehicle, especially carbon monoxide. This is the case, e.g. in enclosed spaces, or if the vehicle is stuck in snow. There is a risk of fatal injuries.

You should switch off the auxiliary heating in enclosed spaces which do not have an extraction system, e.g. a garage. If the vehicle is stuck in snow and you must leave the auxiliary heating running, keep the exhaust pipe and the area around the vehicle clear of snow. To guarantee a sufficient supply of fresh air, open

a window on the side of the vehicle away from the wind.

WARNING

When the auxiliary heating is switched on, parts of the vehicle can become very hot. Flammable materials such as leaves, grass or twigs may ignite if they come into contact with:

- hot parts of the exhaust system
- the exhaust gas itself

There is a risk of fire.

When the auxiliary heating is switched on, make sure that:

- no flammable materials come into contact with hot vehicle components
- the exhaust gas can escape from the exhaust pipe unhindered
- the exhaust gas does not come into contact with flammable materials.

! Operating the auxiliary heating/ventilation draws on the vehicle battery. After you have heated or ventilated the vehicle a maximum of two times, drive for a longer distance.

Only vehicles with auxiliary heating have this function.

In the **Heating** submenu, you can select a stored departure time or change a departure time.







The auxiliary heating timer function calculates the switch-on time according to the outside temperature so that the vehicle is preheated by the departure time. When the departure time is reached, the auxiliary heating continues to heat for a further five minutes and then switches off. The auxiliary heating adopts the set air conditioning or THERMOTRONIC temperature setting.

You can switch off the auxiliary heating by using the remote control or the auxiliary heating button on the centre console.











i Switch the auxiliary heating on regularly once a month for about ten minutes.

Further information on auxiliary heating (> page 128).

Selecting the departure time or deactivating a selected departure time







- ▶ Press the  or  button on the steering wheel to select the **Settings** menu.
- ▶ Press the  or  button to select the **Heating** submenu.
- ▶ Press **OK** to confirm. The current setting appears.
- ▶ Press **OK** again.
- ▶ Press the  or  button to select one of the three departure times or **Timer off** (no timer active).
- ▶ Press **OK** to confirm. If a departure time is selected, the yellow indicator lamp lights up on the auxiliary heating button.

Changing the departure time

- ▶ Press the  or  button on the steering wheel to select the **Settings** menu.
- ▶ Press the  or  button to select the **Heating** submenu.
- ▶ Press **OK** to confirm. The current setting appears.
- ▶ Press the  or  button to select **Change A**, **Change B** or **Change C**.
- ▶ Press **OK** to confirm. You can now change the departure time.
- ▶ Press the  or  button to select the display to be changed: hours, minutes.
- ▶ Press the  or  button to set the selected display.
- ▶ Press the **OK** button to store the entry. The yellow indicator lamp on the auxiliary heating button lights up.

Comfort

Switching belt adjustment on/off

- ▶ Press the  or  button on the steering wheel to select the **Settings** menu.
- ▶ Press the  or  button to select the **Convenience** submenu.
- ▶ Press **OK** to confirm.
- ▶ Press the  or  button to select the **Belt adjustment** function. When the **Belt adjustment** function is activated, the seat belt is displayed in orange in the multifunction display.
- ▶ Press the **OK** button to save the setting.

Further information on belt adjustment (▷ page 44).

Switching the fold mirrors in when locking function on/off

This function is only available when the vehicle is equipped with the electrical fold-in function.

When you activate the **Auto. fold-in mirrors** function, the exterior mirrors are folded in when the vehicle is locked. When you unlock the vehicle and then open the driver's or front-passenger door, the exterior mirrors fold out again.

If you have switched on the **Auto. fold-in mirrors** function and you fold in the exterior mirrors using the button on the door (▷ page 104), they will not fold out automatically. The exterior mirrors can then only be folded out using the button on the door.

- ▶ Press the ◀ or ▶ button on the steering wheel to select the **Settings** menu.
- ▶ Press the ▼ or ▲ button to select the **Convenience** submenu.
- ▶ Press **OK** to confirm.
- ▶ Press the ▼ or ▲ button to select the **Auto. fold-in mirrors** function. If the **Auto. fold-in mirrors** function is switched on, the multifunction display shows the exterior mirror in orange.
- ▶ Press **OK** to save the setting.

Resetting to factory settings

- ▶ Press the ◀ or ▶ button on the steering wheel to select the **Settings** menu.
- ▶ Press the ▼ or ▲ button to select the **Factory setting** submenu.
- ▶ Press **OK** to confirm. The **Reset all settings?** function appears.
- ▶ Press the ▼ or ▲ button to select **No** or **Yes**.
- ▶ Press the **OK** button to confirm the selection. If you have selected **Yes**, the multifunction display shows a confirmation message.

For safety reasons, not all functions are reset: the **Limit speed (winter tyres)** function of the permanent speed limiter can only be set in the **Vehicle** submenu.

If you want to reset the **Daytime driving lights** function in the **Lights** submenu, you

must turn the key to position **1** in the ignition lock.

AMG menu (Mercedes-AMG vehicles)

Warm-up

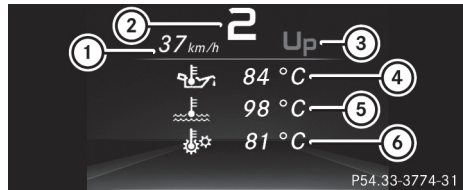

- ① Digital speedometer
- ② Gear indicator
- ③ Upshift indicator
- ④ Engine oil temperature
- ⑤ Coolant temperature
- ⑥ Transmission oil temperature

▶ Press the ◀ or ▶ button on the steering wheel to select the **AMG** menu.

Upshift indicator: upshift indicator **UP** ③ indicates that the engine has reached the overrevving range when in the manual drive program.

Engine and transmission oil temperature: when the engine and transmission are at normal operating temperature, oil temperature ④ and ⑥ are displayed in white in the multifunction display.

If the multifunction display shows oil temperature ④ or ⑥ in blue, the engine or the transmission are not yet at normal operating temperature. Avoid using the full output of the engine during this time.

SETUP



- ① Drive system **Comfort/Sport/Sport +**
- ② Chassis **Comfort/Sport/Sport +**

- ③ Transmission **D/M**
- ④ ESP® **On/Off** or SPORT handling mode **Sport**

SETUP displays the following information and functions:

- digital speedometer
- gear indicator
- drive system setting
- suspension mode
- transmission position
- ESP® (Electronic Stability Program) status
- ▶ Press the or button on the steering wheel to select the **AMG** menu.
- ▶ Press repeatedly until SETUP appears.

RACE TIMER

Displaying and starting the RACE TIMER



- ① Lap
- ② RACE TIMER

The RACE TIMER is intended only for use on a designated race track. Do not use the function on public roads.

When the engine is running or the key is in position **2** in the ignition lock, you can start the RACE TIMER.

- ▶ Press the or button on the steering wheel to select the **AMG** menu.
- ▶ Press the button repeatedly until the RACE TIMER appears.
- ▶ **To start:** press the button to start the RACE TIMER.

Displaying the intermediate time



- ▶ Press the or button to select **Interm. Time**.
- ▶ Press to confirm.
The intermediate time is shown for five seconds.

Starting a new lap



- ① RACE TIMER
- ② Fastest lap time (best lap)
- ③ Lap

- ▶ Press to confirm **New Lap**.

- ❗ A maximum of 16 laps may be stored. The 16th lap can only be completed with **Finish Lap**.

Stopping the RACE TIMER



- ▶ Press the button on the steering wheel.
- ▶ Confirm **Yes** with .

The RACE TIMER interrupts timing if you stop the vehicle and turn the key to position **1** in the ignition lock. If you turn the key to position **3** and then press to confirm **Start**, timing is continued.

Resetting the current lap

- ▶ Stop the RACE TIMER.
- ▶ Press the ◀ or ▶ button to select **Reset Lap**.
- ▶ Press **OK** to reset the lap time to "0".

Deleting all laps



If you switch off the engine, the RACE TIMER is reset to "0" after 30 seconds. All laps are deleted.

You cannot delete individual stored laps. If you have stopped 16 laps, the current lap does not have to be reset.

- ▶ Reset the current lap.
- ▶ Press **OK** to confirm **Reset**. **Reset Race Timer?** appears in the multi-function display.
- ▶ Press the ▼ button to select **Yes** and press the **OK** button to confirm. All laps are deleted.

Overall evaluation

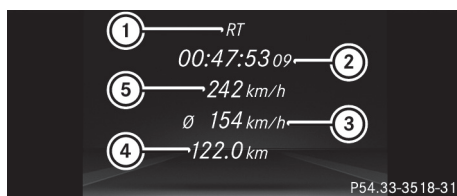

- ① RACETIMER overall evaluation
- ② Total time driven

- ③ Average speed
- ④ Distance covered
- ⑤ Maximum speed

This function is shown if you have stored at least one lap and stopped the RACETIMER.

- ▶ Press ◀ or ▶ on the steering wheel to select the **AMG** menu.
- ▶ Press the ▲ button repeatedly until the overall evaluation appears.

Lap statistics



- ① Lap
- ② Lap time
- ③ Average lap speed
- ④ Lap length
- ⑤ Top speed during lap

This function is only available if you have stored at least two laps and have stopped the RACE-TIMER.

- ▶ Press the ◀ or ▶ button on the steering wheel to select the **AMG** menu.
- ▶ Press the ▲ button repeatedly until a lap evaluation appears. Each lap is shown in a separate submenu. The fastest lap is indicated by flashing symbol ①.
- ▶ Press the ▲ or ▼ button to select a different lap evaluation.

Display messages

Introduction

General notes

Display messages appear in the multifunction display.

Display messages with graphic symbols are simplified in the Owner's Manual and may differ from the symbols in the multifunction display.

Please respond in accordance with the display messages and follow the additional notes in this Owner's Manual.

Certain display messages are accompanied by an audible warning tone or a continuous tone.

When the ignition is switched off, all display messages are deleted apart from some high-priority display messages. Once the causes of the high-priority display messages have been rectified, these display messages are deleted as well.

When you stop and park the vehicle, please observe the notes on:

- HOLD function (▷ page 174)
- Parking (▷ page 157)

Hiding display messages







- ▶ Press the  or  button on the steering wheel. The multifunction display hides the display message.

The multifunction display shows high-priority display messages in red. Some high-priority display messages cannot be hidden.











The multifunction display shows these messages continuously until the causes for the messages have been remedied.







Message memory









The on-board computer saves certain display messages in the **message memory**. You can call up the display messages:







- ▶ Press the  or  button on the steering wheel to select the **Service** menu. If there are display messages, the multifunction display shows **2 messages**, for example.
- ▶ Press the  or  button to select the entry, e.g. **2 messages**.
- ▶ Press  to confirm.
- ▶ Press the  or  button to scroll through the display messages.







Safety systems







Display messages	Possible causes/consequences and ► Solutions
  <p>currently unavailable See Owner's Manual</p>	<p>ABS (Anti-lock Braking System), BAS (Brake Assist System), ESP® (Electronic Stability Program), ESP® trailer stabilisation, the HOLD function, hill start assist and PRE-SAFE® are temporarily unavailable. Adaptive brake lights and Active Brake Assist may have also failed. In addition, the ,  and  warning lamps may light up in the instrument cluster.</p> <p>ATTENTION ASSIST is deactivated.</p> <p>Possible causes:</p> <ul style="list-style-type: none"> • self-diagnosis is not yet complete • the on-board voltage may be insufficient <p>⚠ WARNING</p> <p>The brake system continues to function normally, but without the functions listed above. The wheels could therefore lock if you brake hard, for example.</p> <p>The steerability and braking characteristics may be severely affected. The braking distance may increase in an emergency braking situation. If ESP® is not operational, ESP® is unable to stabilise the vehicle. There is an increased risk of skidding and/or accident.</p> <p>► Carefully drive on a suitable stretch of road, making gentle steering movements at speeds of above 20 km/h. If the display message disappears, the functions mentioned above are available again.</p> <p>If the multifunction display still shows the display message:</p> <ul style="list-style-type: none"> ► Drive on carefully. ► Consult a qualified specialist workshop immediately.
  <p>Inoperative; see Owner's Manual</p>	<p>ABS, BAS, ESP®, ESP® trailer stabilisation, the HOLD function, hill start assist and PRE-SAFE® are unavailable due to a malfunction. Adaptive brake lights and Active Brake Assist may have also failed. The , ,  and  warning lamps may also light up in the instrument cluster.</p> <p>ATTENTION ASSIST is deactivated.</p> <p>⚠ WARNING</p> <p>The brake system continues to function normally, but without the functions listed above. The wheels could therefore lock if you brake hard, for example.</p> <p>The steerability and braking characteristics may be severely affected. The braking distance may increase in an emergency braking situation. If ESP® is not operational, ESP® is unable to stabilise the vehicle. There is an increased risk of skidding and/or accident.</p> <ul style="list-style-type: none"> ► Drive on carefully. ► Consult a qualified specialist workshop immediately.





Display messages	Possible causes/consequences and ► Solutions
 <p>currently unavailable See Owner's Manual</p>	<p>ESP®, ESP® trailer stabilisation, BAS, the HOLD function, hill start assist and PRE-SAFE® are temporarily unavailable. Adaptive brake lights and Active Brake Assist may have also failed. In addition, the  and  warning lamps may light up in the instrument cluster. ATTENTION ASSIST is deactivated. The self-diagnosis function, for example, may not be complete.</p> <p>▲ WARNING</p> <p>The brake system continues to function normally, but without the functions listed above. The braking distance may thus increase in an emergency braking situation. If ESP® is not operational, ESP® is unable to stabilise the vehicle. There is an increased risk of skidding and/or accident.</p> <p>► Carefully drive on a suitable stretch of road, making gentle steering movements at speeds of above 20 km/h. If the display message disappears, the functions mentioned above are available again.</p> <p>If the multifunction display still shows the display message:</p> <ul style="list-style-type: none"> ► Drive on carefully. ► Consult a qualified specialist workshop immediately.
 <p>Inoperative; see Owner's Manual</p>	<p>ESP®, ESP® trailer stabilisation, BAS, the HOLD function, hill start assist and PRE-SAFE® are unavailable due to a malfunction. Adaptive brake lights and Active Brake Assist may have also failed. In addition, the  and  warning lamps may light up in the instrument cluster. ATTENTION ASSIST is deactivated.</p> <p>▲ WARNING</p> <p>The brake system continues to function normally, but without the functions listed above. The braking distance may thus increase in an emergency braking situation. If ESP® is not operational, ESP® is unable to stabilise the vehicle. There is an increased risk of skidding and/or accident.</p> <ul style="list-style-type: none"> ► Drive on carefully. ► Consult a qualified specialist workshop immediately.



Display messages	Possible causes/consequences and ► Solutions
<div style="display: flex; justify-content: space-around;"> <div style="border: 1px solid black; padding: 2px; text-align: center;">EBD</div> <div style="border: 1px solid black; padding: 2px; text-align: center;">(ABS)</div> </div> <div style="border: 1px solid black; padding: 2px; text-align: center; margin-top: 5px;">  </div> <p style="color: blue;">inoperative See Owner's Manual</p>	<p>EBD (electronic brake force distribution), ABS, BAS, ESP®, ESP® trailer stabilisation, the HOLD function, hill start assist and PRE-SAFE® are unavailable due to a malfunction.</p> <p>Adaptive brake lights and Active Brake Assist may have also failed. A warning tone sounds.</p> <p>In addition, the ,  and  warning lamps may light up in the instrument cluster.</p> <p>⚠ WARNING</p> <p>The brake system continues to function normally, but without the functions listed above. The front and rear wheels could therefore lock if you brake hard, for example.</p> <p>The steerability and braking characteristics may be severely affected. The braking distance may increase in an emergency braking situation. If ESP® is not operational, ESP® is unable to stabilise the vehicle. There is an increased risk of skidding and/or accident.</p> <ul style="list-style-type: none"> ► Drive on carefully. ► Consult a qualified specialist workshop immediately.
<div style="border: 1px solid black; padding: 2px; text-align: center; width: 40px; margin: 0 auto;">(P)</div> <p style="color: blue;">Turn on the ignition to release the parking brake</p>	<p>The red  indicator lamp lights up.</p> <p>You attempted to release the electric parking brake while the ignition was switched off.</p> <ul style="list-style-type: none"> ► Key: turn the key to position 1 in the ignition lock. ► KEYLESS-GO: switch on the ignition.
<div style="border: 1px solid black; padding: 2px; text-align: center; width: 40px; margin: 0 auto;">(P)</div> <p style="color: blue;">Release parking brake</p>	<p>The red  indicator lamp flashes and a warning tone sounds. A condition for automatic release of the electric parking brake is not fulfilled (▷ page 160).</p> <p>You are driving with the electric parking brake applied.</p> <ul style="list-style-type: none"> ► Release the electric parking brake manually. <p>The red  indicator lamp flashes and a warning tone sounds. You are initiating emergency braking using the electric parking brake (▷ page 160).</p>
<div style="border: 1px solid black; padding: 2px; text-align: center; width: 40px; margin: 0 auto;">(P)</div> <p style="color: blue;">Parking brake See Owner's Manual</p>	<p>The yellow  warning lamp lights up. The electric parking brake is malfunctioning.</p> <p>To apply:</p> <ul style="list-style-type: none"> ► Switch the ignition off. ► Push and hold the electric parking brake handle for at least ten seconds. ► Vehicles with manual transmission: engage first gear. ► Vehicles with automatic transmission: shift the transmission to position P. ► Consult a qualified specialist workshop.



Display messages	Possible causes/consequences and ► Solutions
	<p>The yellow  warning lamp and the red  indicator lamp are lit. The electric parking brake is malfunctioning.</p> <p>To release:</p> <ul style="list-style-type: none"> ► Switch the ignition off and then on again. ► Release the electric parking brake manually. <p>or</p> <ul style="list-style-type: none"> ► Vehicles with manual transmission (automatic emergency release): insert the seat belt in the belt buckle and accelerate slightly more when pulling away. ► Vehicles with automatic transmission: release the electric parking brake automatically (► page 160). <p>If the electric parking brake still cannot be released:</p> <ul style="list-style-type: none"> ► Do not drive on. ► Consult a qualified specialist workshop. <hr/> <p>The red  indicator lamp flashes and the yellow  warning lamp is lit. The electric parking brake is malfunctioning.</p> <p>To release:</p> <ul style="list-style-type: none"> ► Switch the ignition off and then on again. ► Release the electric parking brake manually. <p>To apply:</p> <ul style="list-style-type: none"> ► Switch the ignition off and then on again. ► Apply the electric parking brake manually. <p>If the red  indicator lamp continues to flash:</p> <ul style="list-style-type: none"> ► Do not drive on. ► Secure the vehicle against rolling away (► page 326). ► Vehicles with manual transmission: engage first gear. ► Vehicles with automatic transmission: shift the transmission to position . ► Turn the front wheels towards the kerb. ► Consult a qualified specialist workshop.

Display messages	Possible causes/consequences and ► Solutions
	<p>The yellow  warning lamp lights up. The red indicator lamp  flashes for about ten seconds after the electric parking brake has been applied or released. It then goes out or remains lit.</p> <p>The electric parking brake is malfunctioning.</p> <ul style="list-style-type: none"> ► Switch the ignition off and then on again. ► Apply the electric parking brake. <p>If you cannot apply the electric parking brake:</p> <ul style="list-style-type: none"> ► Vehicles with manual transmission: engage first gear. ► Vehicles with automatic transmission: shift the transmission to position . ► Consult a qualified specialist workshop. <p>If it is not possible to release the electric parking brake:</p> <ul style="list-style-type: none"> ► Vehicles with manual transmission (automatic emergency release): insert the seat belt in the belt buckle and accelerate slightly more when pulling away. ► Vehicles with automatic transmission: release the electric parking brake automatically (> page 158). <p>If the electric parking brake still cannot be released:</p> <ul style="list-style-type: none"> ► Consult a qualified specialist workshop.
	<p>The yellow  warning lamp lights up. If you manually apply or release the electric parking brake, the red  indicator lamp flashes.</p> <p>The electric parking brake is malfunctioning. The electric parking brake cannot be applied manually.</p> <ul style="list-style-type: none"> ► Vehicles with manual transmission: switch off the ignition. The electric parking brake is applied automatically. <p>or</p> <ul style="list-style-type: none"> ► Insert the seat belt in the belt buckle and accelerate slightly more when pulling away (automatic emergency release). ► Vehicles with automatic transmission: shift the transmission to position  as the electric parking brake is not applied automatically. ► Consult a qualified specialist workshop. <p>If you do not wish the electric parking brake to be applied, leave the ignition switched on, e.g. when washing the vehicle in an automatic car wash or when having the vehicle towed.</p>

Display messages	Possible causes/consequences and ► Solutions
 <p>Parking brake inoperative</p>	<p>The yellow  warning lamp lights up. The red indicator lamp  flashes for about ten seconds after the electric parking brake has been applied or released. It then goes out or remains lit.</p> <p>The electric parking brake is malfunctioning, e.g. because of over-voltage or undervoltage.</p> <ul style="list-style-type: none"> ► Rectify the cause of the overvoltage or undervoltage, e.g. by charging the battery or restarting the engine. ► Apply or release the electric parking brake. <p>If the electric parking brake still cannot be applied or released:</p> <ul style="list-style-type: none"> ► Switch the ignition off and then on again. ► Apply or release the electric parking brake. <p>If the electric parking brake still cannot be released:</p> <ul style="list-style-type: none"> ► Consult a qualified specialist workshop. <p>If the electric parking brake still cannot be applied:</p> <ul style="list-style-type: none"> ► Consult a qualified specialist workshop. <p>The red  indicator lamp flashes and the yellow  warning lamp is lit.</p> <p>The electric parking brake cannot be applied manually.</p> <ul style="list-style-type: none"> ► Vehicles with manual transmission: engage first gear. ► Vehicles with automatic transmission: shift the transmission to position . ► Consult a qualified specialist workshop.
 <p>Brake immediately</p>	<p>Vehicles with manual transmission: a malfunction has occurred while the HOLD function was activated.</p> <p>A tone may also sound at regular intervals. If you attempt to lock the vehicle, the tone becomes louder.</p> <p>You cannot start the engine.</p> <ul style="list-style-type: none"> ► Paying attention to the traffic situation, immediately depress the brake pedal firmly and hold until the display message disappears. ► Secure the vehicle against rolling away (► page 157). You can restart the engine.

Display messages	Possible causes/consequences and ► Solutions
 <p>Check brake fluid level</p>	<p>There is insufficient brake fluid in the brake fluid reservoir. In addition, the red  warning lamp lights up on the instrument cluster and a warning tone sounds.</p> <p>▲ WARNING</p> <p>Braking efficiency may be impaired. There is a risk of an accident.</p> <ul style="list-style-type: none"> ► Stop the vehicle safely as soon as possible, paying attention to road and traffic conditions. Do not drive on. ► Secure the vehicle against rolling away (▷ page 157). ► Consult a qualified specialist workshop. ► Do not top up the brake fluid. This does not correct the fault.
 <p>Check brake pad wear</p>	<p>The brake pads/linings have reached their wear limit.</p> <ul style="list-style-type: none"> ► Consult a qualified specialist workshop.
 <p>Inoperative</p>	<p>At least one main function of the Mercedes-Benz connect me system is malfunctioning.</p> <ul style="list-style-type: none"> ► Consult a qualified specialist workshop.
 <p>Inoperative</p>	<p>At least one main function of the Mercedes-Benz Contact system is malfunctioning.</p> <ul style="list-style-type: none"> ► Consult a qualified specialist workshop.
<p>Active Brake Assist Functions currently limited See Owner's Manual</p>	<p>Active Brake Assist is temporarily inoperative.</p> <p>Possible causes:</p> <ul style="list-style-type: none"> • the radar sensor system is temporarily inoperative, e.g. due to electromagnetic radiation emitted by nearby TV or radio stations or other sources of electromagnetic radiation • the system is outside the operating temperature range • the on-board voltage is too low <p>Once the causes listed above no longer apply, the display message disappears.</p> <p>Active Brake Assist is operational again.</p> <p>If the display message does not disappear:</p> <ul style="list-style-type: none"> ► Stop the vehicle, paying attention to road and traffic conditions. ► Secure the vehicle against rolling away (▷ page 157). ► Restart the engine.
<p>Active Brake Assist: System inoperative</p>	<p>Active Brake Assist is unavailable due to a malfunction. Situation-dependent braking assistance may also have failed.</p> <ul style="list-style-type: none"> ► Consult a qualified specialist workshop immediately.
<p>PRE-SAFE inoperative; see Owner's Manual</p>	<p>Important PRE-SAFE® functions have failed. All other occupant safety systems, e.g. airbags, remain available.</p> <ul style="list-style-type: none"> ► Consult a qualified specialist workshop immediately.

Display messages	Possible causes/consequences and ► Solutions
<p>Radar sensors dirty See Owner's Manual</p>	<p>The radar sensor system is malfunctioning.</p> <p>Possible causes:</p> <ul style="list-style-type: none"> • dirt on sensors • heavy rain or snow • driving on inter-urban roads without traffic or infrastructure, e.g. in desert-like areas <p>At least one driving system or driving safety system is malfunctioning or is temporarily unavailable:</p> <ul style="list-style-type: none"> • Active Brake Assist • Distance Pilot DISTRONIC <p>A warning tone also sounds.</p> <p>Once the cause of the problem is no longer present, the driving and driving safety systems will be available again. The display message disappears.</p> <p>If the display message does not disappear:</p> <ul style="list-style-type: none"> ► Stop the vehicle, paying attention to road and traffic conditions. ► Secure the vehicle against rolling away (▷ page 157). ► Switch off the engine. ► Clean all sensors (▷ page 294). ► Restart the engine. <p>The display message disappears.</p>
	<p>If this symbol appears on the multifunction display, a seat belt tongue has been inserted into a rear seat belt buckle.</p> <p>Further information on the status indicator for the rear seat belts (▷ page 45).</p>
	<p>If this symbol appears on the multifunction display, a seat belt tongue has not been inserted in a rear seat belt buckle.</p> <p> WARNING</p> <p>A seat belt which is not worn correctly, or which has not been engaged in the seat belt buckle correctly, cannot provide the intended level of protection.</p> <p>This poses an increased risk of injury.</p> <ul style="list-style-type: none"> ► If necessary, ask the vehicle occupants in the rear to fasten their seat belts (▷ page 44). <p>Further information on the status indicator for the rear seat belts (▷ page 45).</p>

Display messages	Possible causes/consequences and ► Solutions
 <p>Restraint sys. malfunction Consult workshop</p>	<p>The restraint system is malfunctioning. The  warning lamp also lights up on the instrument cluster.</p> <p>▲ WARNING</p> <p>The airbags or belt tensioners may either be triggered unintentionally or, in the event of an accident, may not be triggered. This poses an increased risk of injury.</p> <p>► Consult a qualified specialist workshop immediately.</p> <p>Further information on the restraint system (► page 40).</p>
 <p>Front left malfunction Consult workshop or Front right malfunction Consult workshop</p>	<p>The front left or right restraint system is malfunctioning. The  warning lamp also lights up on the instrument cluster.</p> <p>▲ WARNING</p> <p>The airbags or belt tensioners may either be triggered unintentionally or, in the event of an accident, may not be triggered. This poses an increased risk of injury.</p> <p>► Consult a qualified specialist workshop immediately.</p>
 <p>Rear left malfunction Consult workshop or Rear right malfunction Consult workshop</p>	<p>The rear left or right restraint system is malfunctioning. The  warning lamp also lights up on the instrument cluster.</p> <p>▲ WARNING</p> <p>The airbags or belt tensioners may either be triggered unintentionally or, in the event of an accident, may not be triggered. This poses an increased risk of injury.</p> <p>► Consult a qualified specialist workshop immediately.</p>
 <p>Rear centre malfunction Consult workshop</p>	<p>The rear centre restraint system is malfunctioning. The  warning lamp also lights up on the instrument cluster.</p> <p>▲ WARNING</p> <p>The airbags or belt tensioners may either be triggered unintentionally or, in the event of an accident, may not be triggered. This poses an increased risk of injury.</p> <p>► Consult a qualified specialist workshop immediately.</p>
 <p>Left windowbag malfunction Consult workshop or Right windowbag malfunction Consult workshop</p>	<p>The left-hand or right-hand windowbag is malfunctioning. The  warning lamp also lights up in the instrument cluster.</p> <p>▲ WARNING</p> <p>The left-hand or right-hand windowbag may either be triggered unintentionally or, in the event of an accident, not triggered at all. This poses an increased risk of injury.</p> <p>► Consult a qualified specialist workshop immediately.</p>







Display messages	Possible causes/consequences and ► Solutions
<p>Front-passenger airbag disabled See Owner's Manual</p>	<p>The front-passenger front airbag is disabled during the journey although:</p> <ul style="list-style-type: none"> • an adult or • a person of corresponding stature is on the front-passenger seat <p>If additional forces are applied to the seat, the weight the system detects may be too low.</p> <p> WARNING</p> <p>The front-passenger front airbag does not deploy during an accident. This poses an increased risk of injury.</p> <ul style="list-style-type: none"> ► Stop the vehicle safely as soon as possible, paying attention to road and traffic conditions. ► Secure the vehicle against rolling away (▷ page 157). ► Switch the ignition off. ► Have the vehicle occupant on the front-passenger seat step out of the vehicle. ► Make sure that the seat is unoccupied, close the front-passenger door and switch on the ignition. ► Observe the PASSENGER AIR BAG indicator lamps on the centre console and the multifunction display and check the following: <ul style="list-style-type: none"> Seat unoccupied and ignition switched on: <ul style="list-style-type: none"> • a self-diagnosis is carried out. The PASSENGER AIR BAG OFF and PASSENGER AIR BAG ON indicator lamps light up simultaneously for approximately six seconds • the PASSENGER AIR BAG OFF indicator lamp must then light up and remain lit after the self-diagnosis. If the indicator lamp is on, the automatic front-passenger front airbag deactivation system has disabled the front-passenger front airbag (▷ page 48) • the Front-passenger airbag enabled See Owner's Manual or Front-passenger airbag disabled See Owner's Manual display messages must not be shown on the multifunction display ► Wait for a period of at least 60 seconds until the necessary system checks have been completed. ► Make sure that the display messages do not appear on the multifunction display. <p>If these conditions are met, the front-passenger seat can be occupied again. Whether the PASSENGER AIR BAG OFF or ON indicator lamp remains lit or goes out depends on how the automatic front-passenger front airbag deactivation system classifies the vehicle occupant. If the conditions are not met, the system is not operating correctly.</p> <ul style="list-style-type: none"> ► Consult a qualified specialist workshop immediately. <p>Further information on the automatic front-passenger front airbag deactivation system (▷ page 48).</p>











Display messages	Possible causes/consequences and ► Solutions
<p>Front-passenger airbag enabled See Owner's Manual</p>	<p>The front-passenger front airbag is enabled during the journey although:</p> <ul style="list-style-type: none"> • a child, a small adult or an object weighing less than the system weight threshold is located on the front-passenger seat or • the front-passenger seat is not occupied <p>The system may detect objects or forces that are placing additional weight on the seat.</p> <p> WARNING</p> <p>The front-passenger front airbag may deploy unintentionally. This poses an increased risk of injury.</p> <ul style="list-style-type: none"> ► Stop the vehicle safely as soon as possible, paying attention to road and traffic conditions. ► Secure the vehicle against rolling away (► page 157). ► Switch the ignition off. ► Open the front-passenger door. ► Remove the child and child seat from the front-passenger seat. ► Make sure that no objects are present that are applying additional weight to the seat. <p>The system might otherwise detect the additional weight and interpret the vehicle seat occupant's weight as greater than it actually is.</p> <ul style="list-style-type: none"> ► Make sure that the seat is unoccupied, close the front-passenger door and switch on the ignition. ► Observe the PASSENGER AIR BAG indicator lamps on the centre console and the multifunction display and check the following: Seat unoccupied and ignition switched on: <ul style="list-style-type: none"> • a self-diagnosis is carried out. The PASSENGER AIR BAG OFF and PASSENGER AIR BAG ON indicator lamps light up simultaneously for approximately six seconds • the PASSENGER AIR BAG OFF indicator lamp must then light up and remain lit after the self-diagnosis. If the indicator lamp is on, the automatic front-passenger front airbag deactivation system has disabled the front-passenger front airbag (► page 48) • the Front-passenger airbag enabled See Owner's Manual or Front-passenger airbag disabled See Owner's Manual display messages must not be shown on the multifunction display ► Wait for a period of at least 60 seconds until the necessary system checks have been completed. ► Make sure that the display messages do not appear on the multifunction display. <p>If these conditions are met, the front-passenger seat can be occupied again. Whether the PASSENGER AIR BAG OFF or ON indicator lamp remains lit or goes out depends on how the automatic front-passenger front airbag deactivation system classifies the vehicle occupant.</p> <p>If the conditions are not met, the system is not operating correctly.</p> <ul style="list-style-type: none"> ► Consult a qualified specialist workshop immediately.





Display messages	Possible causes/consequences and ► Solutions
	Further information on the automatic front-passenger front airbag deactivation system (► page 48).



Lights





- i** Vehicles with LED light bulbs in the light clusters:
The display message for the corresponding lamp only appears when all the LEDs in the lamp have failed.







Display messages	Possible causes/consequences and ► Solutions
 Left dipped beam or Right dipped beam	The left or right-hand dipped-beam headlamp is faulty. ► Check whether you are permitted to replace the bulb yourself (► page 111). or ► Consult a qualified specialist workshop.
 Trailer left tail lamp or Trailer right tail lamp	The left or right-hand trailer tail lamp is faulty. ► Consult the manufacturer's operating instructions.
 Trailer left turn signal or Trailer right turn signal	The left or right-hand trailer turn signal lamp is faulty. ► Consult the manufacturer's operating instructions.
 Trailer brake lamp	The trailer brake lamp is faulty. ► Consult the manufacturer's operating instructions.
 Rear left indicator or Rear right indicator	The rear left-hand or rear right-hand turn signal is faulty. ► Check whether you are permitted to replace the bulb yourself (► page 111). or ► Consult a qualified specialist workshop.
 Front left indicator or Front right indicator	The front left-hand or front right-hand turn signal is faulty. ► Check whether you are permitted to replace the bulb yourself (► page 111). or ► Consult a qualified specialist workshop.
 Left mirror indicator or Right mirror indicator	The turn signal in the left-hand or right-hand exterior mirror is faulty. ► Consult a qualified specialist workshop.



Display messages	Possible causes/consequences and ► Solutions
 Third brake lamp	The third brake lamp is faulty. ► Consult a qualified specialist workshop.
 Left brake lamp or Right brake lamp	The left or right-hand brake lamp is faulty. ► Consult a qualified specialist workshop.
 Left main beam or Right main beam	The left or right-hand main-beam headlamp is faulty. ► Check whether you are permitted to replace the bulb yourself (▷ page 111). or ► Consult a qualified specialist workshop.
 Number plate lamp	The left or right-hand licence plate lamp is faulty. ► Consult a qualified specialist workshop.
 Rear foglamp	The rear foglamp is faulty. ► Check whether you are permitted to replace the bulb yourself (▷ page 111). or ► Consult a qualified specialist workshop.
 Front left parking lamp or Front right parking lamp	The front left or front right parking lamp is faulty. ► Check whether you are permitted to replace the bulb yourself (▷ page 111). or ► Consult a qualified specialist workshop.
 Reversing light	The reversing lamp is faulty. ► Check whether you are permitted to replace the bulb yourself (▷ page 111). or ► Consult a qualified specialist workshop.
 Left tail lamp or Right tail lamp	The left or right-hand tail lamp is faulty. ► Consult a qualified specialist workshop.
 Left daytime driv- ing lamp or Right daytime driving lamp	The left or right-hand daytime driving lamp is faulty. ► Check whether you are permitted to replace the bulb yourself (▷ page 111). or ► Consult a qualified specialist workshop.
	The exterior lighting is faulty. ► Consult a qualified specialist workshop.



Display messages	Possible causes/consequences and ► Solutions
Malfunction See Owner's Manual	Vehicles with trailer tow hitch: a fuse may have blown. <ul style="list-style-type: none"> ► Stop the vehicle, paying attention to road and traffic conditions. ► Secure the vehicle against rolling away (▷ page 157). ► Check the fuses (▷ page 313). ► If necessary, replace the blown fuse. Observe the warning notes as you do so. If the multifunction display still shows the display message: <ul style="list-style-type: none"> ► Consult a qualified specialist workshop.
 AUTO lights inoperative	The light sensor is faulty. <ul style="list-style-type: none"> ► Consult a qualified specialist workshop.
 Switch off lights	The lights are still switched on when you leave the vehicle. A warning tone also sounds. <ul style="list-style-type: none"> ► Turn the light switch to the AUTO position.
 Switch on headlamps	You are driving without dipped-beam headlamps. <ul style="list-style-type: none"> ► Turn the light switch to the  or AUTO position.
Adaptive Main-beam Assist currently unavailable See Owner's Manual	Adaptive Highbeam Assist is deactivated and temporarily inoperative. Possible causes: <ul style="list-style-type: none"> • the windscreen is dirty in the camera's field of vision • visibility is impaired due to heavy rain, snow or fog ► Clean the windscreen. <p>If the system detects that the camera is fully operational again, the Adaptive Main-beam Assist available again message is displayed.</p> Adaptive Highbeam Assist is operational again.
Adaptive Main-beam Assist inoperative	Adaptive Highbeam Assist is faulty. <ul style="list-style-type: none"> ► Consult a qualified specialist workshop.

Engine	
Display messages	Possible causes/consequences and ► Solutions
 <p>Top up coolant See Owner's Manual</p>	<p>The coolant level is too low.</p> <p>! Avoid making long journeys with too little coolant in the engine cooling system. The engine will otherwise be damaged.</p> <ul style="list-style-type: none"> ► Top up the coolant, making sure to observe the warning notes (► page 288). <p>If you have to top up the coolant frequently:</p> <ul style="list-style-type: none"> ► Consult a qualified specialist workshop and have the engine cooling system checked.
	<p>The fan motor is faulty.</p> <ul style="list-style-type: none"> ► If the coolant temperature is below 120 °C, drive on to the nearest qualified specialist workshop. ► Avoid heavy loads on the engine as you do so, e.g. driving in mountainous terrain and stop-start traffic.
 <p>Coolant Stop vehicle Switch engine off</p>	<p>The coolant is too hot. A warning tone also sounds.</p> <p>⚠ WARNING</p> <p>Never drive with an overheated engine. Driving when your engine has overheated can cause any fluids that may have leaked into the engine compartment to catch fire.</p> <p>In addition, steam from an overheated engine can cause serious burns, which can occur just by opening the bonnet. There is a risk of injury.</p> <ul style="list-style-type: none"> ► Stop the vehicle immediately, paying attention to road and traffic conditions, and switch off the engine. ► Secure the vehicle against rolling away (► page 157). ► Wait until the engine has cooled down. ► Make sure that the air supply to the engine radiator is not blocked, e.g. by frozen slush. ► Do not start the engine again until the display message disappears and the coolant temperature is below 120 °C. The engine may otherwise be damaged. ► Pay attention to the coolant temperature gauge. <p>If the temperature increases again:</p> <ul style="list-style-type: none"> ► Consult a qualified specialist workshop immediately. <p>Under normal operating conditions and with the correct coolant level, the display may rise to 120 °C.</p>

Display messages	Possible causes/consequences and ► Solutions
 <p>See Owner's Manual</p>	<p>The battery is no longer being charged. A warning tone also sounds.</p> <p>Possible causes:</p> <ul style="list-style-type: none"> • faulty alternator • torn poly-V-belt • a malfunction in the electronics <p>! Do not continue driving. The engine could otherwise overheat.</p> <ul style="list-style-type: none"> ► Stop the vehicle immediately, paying attention to road and traffic conditions, and switch off the engine. ► Secure the vehicle against rolling away (▷ page 157). ► Consult a qualified specialist workshop.
 <p>Stop vehicle See Owner's Manual</p>	<p>The battery is no longer being charged and the charge status is too low. A warning tone also sounds.</p> <ul style="list-style-type: none"> ► Stop the vehicle immediately, paying attention to road and traffic conditions, and switch off the engine. ► Secure the vehicle against rolling away (▷ page 157). ► Observe the instructions in the  See Owner's Manual display message. ► Consult a qualified specialist workshop.
 <p>Check eng. oil lev. when next refuelling</p>	<p>The engine oil level has dropped to the minimum level. A warning tone also sounds.</p> <p>! Avoid long journeys when there is too little coolant in the cooling system. Otherwise the engine will be damaged.</p> <ul style="list-style-type: none"> ► Check the oil level when next refuelling, at the latest (▷ page 286). ► If necessary, top up the engine oil (▷ page 287). <p>If you have to top up the engine oil frequently:</p> <ul style="list-style-type: none"> ► Consult a qualified specialist workshop and have the engine checked. <p>Information on approved engine oils can be obtained from any qualified specialist workshop or on the internet at http://bevo.mercedes-benz.com.</p>

Display messages	Possible causes/consequences and ► Solutions
 <p data-bbox="115 220 344 292">Add 1 litre engine oil when next refuelling</p>	<p data-bbox="372 172 899 196">The engine oil level has dropped to the minimum level.</p> <p data-bbox="372 212 1033 260">! Avoid long journeys when there is too little coolant in the cooling system. Otherwise the engine will be damaged.</p> <ul data-bbox="372 276 1033 323" style="list-style-type: none"> ► Check the oil level when next refuelling, at the latest (▷ page 286). ► If necessary, top up the engine oil (▷ page 287). <p data-bbox="372 339 854 363">If you have to top up the engine oil frequently:</p> <ul data-bbox="372 379 977 427" style="list-style-type: none"> ► Consult a qualified specialist workshop and have the engine checked. <p data-bbox="372 443 1033 515">Information on approved engine oils can be obtained from any qualified specialist workshop or on the internet at http://bevo.mercedes-benz.com.</p>
 <p data-bbox="115 587 344 659">Engine oil level Stop vehicle Switch engine off</p>	<p data-bbox="372 539 988 563">The engine oil level is too low. There is a risk of engine damage.</p> <ul data-bbox="372 571 1022 707" style="list-style-type: none"> ► Stop the vehicle immediately, paying attention to road and traffic conditions, and switch off the engine. ► Secure the vehicle against rolling away (▷ page 157). ► Check the engine oil level (▷ page 286). ► If necessary, top up the engine oil (▷ page 287).
 <p data-bbox="115 786 328 810">Reserve fuel level</p>	<p data-bbox="372 738 854 762">The fuel level has dropped into the reserve range.</p> <p data-bbox="372 770 1033 818">Operation of the auxiliary heating is deactivated if the fuel level drops into the reserve range.</p> <ul data-bbox="372 826 731 850" style="list-style-type: none"> ► Refuel at the nearest filling station.
	<p data-bbox="372 882 742 906">There is very little fuel in the fuel tank.</p> <p data-bbox="372 914 843 938">Operation of the auxiliary heating is deactivated.</p> <ul data-bbox="372 946 820 970" style="list-style-type: none"> ► You must refuel at the nearest filling station.
 <p data-bbox="115 1042 344 1066">Replace air cleaner</p>	<p data-bbox="372 994 1033 1042">Vehicles with a diesel engine: the engine air filter is dirty and must be replaced.</p> <ul data-bbox="372 1050 776 1074" style="list-style-type: none"> ► Consult a qualified specialist workshop.
 <p data-bbox="115 1153 344 1193">Clean the fuel filter</p>	<p data-bbox="372 1106 1033 1153">Vehicles with a diesel engine: there is water in the fuel filter. The water must be drained off.</p> <ul data-bbox="372 1161 776 1185" style="list-style-type: none"> ► Consult a qualified specialist workshop.



Driving systems	
Display messages	Possible causes/consequences and ► Solutions
 Attention Assist: Take a break!	<p>Based on certain criteria, ATTENTION ASSIST has detected fatigue or increasing lapses in concentration on the part of the driver. A warning tone also sounds.</p> <p>► If necessary, take a break.</p> <p>During long journeys, take regular breaks in good time so that you get enough rest.</p>
 Attention Assist inoperative	<p>ATTENTION ASSIST is inoperative.</p> <p>► Consult a qualified specialist workshop.</p>
 Off	<p>The HOLD function is deactivated. The vehicle has started to skid. A warning tone also sounds.</p> <p>► Reactivate the HOLD function later (▷ page 175).</p>
	<p>The HOLD function is deactivated. When the brake pedal is firmly depressed, an activation condition is no longer fulfilled. A warning tone also sounds.</p> <p>► Check the activation conditions for the HOLD function (▷ page 175).</p>
Lane Keeping Assist currently unavailable See Owner's Manual	<p>Lane Keeping Assist is deactivated and temporarily inoperative. Possible causes:</p> <ul style="list-style-type: none"> • the windscreen is dirty in the camera's field of vision • visibility is impaired due to heavy rain, snow or fog • there have been no lane markings for an extended period • the lane markings are worn away, dark or covered up, e.g. by dirt or snow <p>Once the causes listed above no longer apply, the display message disappears.</p> <p>Lane Keeping Assist is operational again.</p> <p>If the display message does not disappear:</p> <p>► Stop the vehicle, paying attention to road and traffic conditions.</p> <p>► Secure the vehicle against rolling away (▷ page 157).</p> <p>► Clean the windscreen.</p>
Lane Keeping Assist inoperative	<p>Lane Keeping Assist is faulty.</p> <p>► Consult a qualified specialist workshop.</p>

Display messages	Possible causes/consequences and ► Solutions
<p>Blind Spot Assist currently unavailable See Owner's Manual</p>	<p>Blind Spot Assist is temporarily inoperative. Possible causes:</p> <ul style="list-style-type: none"> • the radar sensor system is temporarily inoperative, e.g. due to electromagnetic radiation emitted by nearby TV or radio stations or other sources of electromagnetic radiation • the radar sensor system is outside the operating temperature range <p>The yellow  indicator lamps also light up in the exterior mirrors. Once the causes listed above no longer apply, the display message disappears.</p> <p>Blind Spot Assist is operational again. If the display message does not disappear:</p> <ul style="list-style-type: none"> ► Stop the vehicle, paying attention to road and traffic conditions. ► Secure the vehicle against rolling away (▷ page 157). ► Restart the engine.
<p>Blind Spot Assist not available when towing a trailer See Owner's Manual.</p>	<p>Blind Spot Assist is deactivated while towing a trailer. You have established the electrical connection between the trailer and your vehicle.</p> <ul style="list-style-type: none"> ► Press  on the steering wheel to confirm the display message.
<p>Blind Spot Assist inoperative</p>	<p>Blind Spot Assist is malfunctioning. The yellow  indicator lamps also light up in the exterior mirrors.</p> <ul style="list-style-type: none"> ► Consult a qualified specialist workshop.
<p>Parking Pilot cancelled</p>	<p>The driver's door is open and the driver's seat belt has not been fastened.</p> <ul style="list-style-type: none"> ► Repeat the parking process with the seat belt fastened and the driver's door closed. <p>You inadvertently touched the multifunction steering wheel while steering intervention was active.</p> <ul style="list-style-type: none"> ► While steering intervention is active, make sure not to touch the multifunction steering wheel. <p>The vehicle has started to skid and ESP® has intervened.</p> <ul style="list-style-type: none"> ► Use Parking Pilot again later (▷ page 181).
<p>Parking Pilot inoperative</p>	<p>You have just carried out a large number of turning or parking manoeuvres. Parking Pilot will become available again after approximately ten minutes (▷ page 181).</p> <ul style="list-style-type: none"> ► Stop the vehicle, paying attention to road and traffic conditions. ► Switch off and restart the engine. <p>If the multifunction display still shows the display message:</p> <ul style="list-style-type: none"> ► Consult a qualified specialist workshop.

Display messages	Possible causes/consequences and ► Solutions
	<p>Parking Assist PARKTRONIC is faulty.</p> <p>► Consult a qualified specialist workshop.</p>
Parking Pilot ended	<p>The vehicle is parked. A warning tone also sounds.</p> <p>The display message disappears automatically.</p>
Traffic Sign Assist currently unavailable See Owner's Manual	<p>Traffic Sign Assist is temporarily inoperative.</p> <p>Possible causes:</p> <ul style="list-style-type: none"> • the windscreen is dirty in the camera's field of vision • visibility is impaired due to heavy rain, snow or fog <p>► Clean the windscreen.</p> <p>If the system detects that the camera is fully operational, the display message disappears.</p> <p>Traffic Sign Assist is operational again.</p>
Traffic Sign Assist inoperative	<p>Traffic Sign Assist is faulty.</p> <p>► Consult a qualified specialist workshop.</p>
Distance Pilot off	<p>Distance Pilot DISTRONIC is deactivated (▷ page 172).</p> <p>If it was not deactivated by the driver, a warning tone also sounds.</p>
Distance Pilot available again	<p>Distance Pilot DISTRONIC is operational again after having been temporarily unavailable. You can now reactivate Distance Pilot DISTRONIC (▷ page 170).</p>
Distance Pilot currently unavailable See Owner's Manual	<p>Distance Pilot DISTRONIC is temporarily inoperative.</p> <p>Possible causes:</p> <ul style="list-style-type: none"> • the radar sensor system is temporarily inoperative, e.g. due to electromagnetic radiation emitted by nearby TV or radio stations or other sources of electromagnetic radiation • the system is outside the operating temperature range • the on-board voltage is too low <p>A warning tone also sounds.</p> <p>Once the causes listed above no longer apply, the display message disappears.</p> <p>Distance Pilot DISTRONIC is operational again.</p> <p>If the display message does not disappear:</p> <ul style="list-style-type: none"> ► Stop the vehicle, paying attention to road and traffic conditions. ► Secure the vehicle against rolling away (▷ page 157). ► Restart the engine.
Distance Pilot inoperative	<p>Distance Pilot DISTRONIC is faulty. Situation-dependent braking assistance may also have failed.</p> <p>A warning tone also sounds.</p> <p>► Consult a qualified specialist workshop.</p>

Display messages	Possible causes/consequences and ► Solutions
Distance Pilot pas- sive	You have depressed the accelerator pedal. Distance Pilot DISTRONIC is no longer controlling the speed of the vehicle. ► Remove your foot from the accelerator pedal.
Distance Pilot - - - km/h	A condition for activating Distance Pilot DISTRONIC has not been met. ► Check the activation conditions for Distance Pilot DISTRONIC (▷ page 170).
Distance Pilot and Limiter inoperative	Distance Pilot DISTRONIC and speed limiter are faulty. A warning tone also sounds. ► Consult a qualified specialist workshop.
Cruise control and Limiter inoperative	Cruise control and speed limiter are faulty. A warning tone also sounds. ► Consult a qualified specialist workshop.
Limiter passive	If you depress the accelerator pedal beyond the pressure point (kick-down), the limiter is switched to passive mode. The speed limitation is not active. ► Drive slower than the stored speed and without kickdown. ► Call up the last speed stored again. or ► Set a new speed. When the display message disappears, the speed limitation is active.
Cruise control - - - km/h	<ul style="list-style-type: none"> • A condition for activating cruise control has not been met. You have tried to store a speed below 30 km/h, for example. • ESP® is deactivated The yellow ESP® OFF warning lamp is lit. ► If conditions permit, drive at a speed greater than 30 km/h and store the speed. or ► Check the activation conditions for cruise control (▷ page 165). or ► Reactivate ESP® (▷ page 210).
120 km/h! Maximum speed excee- ded	For certain countries only: the maximum speed has been exceeded. In addition, the multifunction display shows 120 km/h!. ► Drive more slowly.

Tyres	
Display messages	Possible causes/consequences and ► Solutions
Tyre pressure Check tyre(s)	<p>The tyre pressure loss warning system has detected a significant loss in pressure. A warning tone also sounds. Possible cause:</p> <ul style="list-style-type: none"> • you have changed the positions of the wheels and tyres or fitted new wheels and tyres • the tyre pressure in one or more tyres has dropped <p> WARNING</p> <p>Underinflated tyres pose the following risks:</p> <ul style="list-style-type: none"> • the tyres may burst, especially as the load and vehicle speed increase • the tyres may wear excessively and/or unevenly, which may greatly impair tyre traction • the driving characteristics, as well as steering and braking, may be greatly impaired <p>There is a risk of an accident.</p> <ul style="list-style-type: none"> ► Stop the vehicle without making any sudden steering or braking manoeuvres. Pay attention to the traffic conditions as you do so. ► Secure the vehicle against rolling away (▷ page 157). ► Check the tyres and, if necessary, follow the instructions for a flat tyre (▷ page 299). ► Check and, if necessary, correct the tyre pressures. ► Restart the tyre pressure loss warning system when the tyre pressure is correct (▷ page 321).
Check tyre pressures then restart Run Flat Indicator	<p>The tyre pressure loss warning system generated a display message and has not been restarted since.</p> <ul style="list-style-type: none"> ► Set the correct tyre pressure in all four tyres. ► Restart the tyre pressure loss warning system (▷ page 321).
Run Flat Indicator inoperative	<p>The tyre pressure loss warning system is faulty.</p> <ul style="list-style-type: none"> ► Consult a qualified specialist workshop.
Rectify tyre pressure	<p>The tyre pressure is too low in at least one of the tyres, or the tyre pressure difference between the wheels is too great.</p> <ul style="list-style-type: none"> ► Check the tyre pressures at the next opportunity (▷ page 322). ► If necessary, correct the tyre pressure. ► Restart the tyre pressure monitor (▷ page 323).



Display messages	Possible causes/consequences and ► Solutions
<p>Check tyre(s)</p>	<p>The tyre pressure in one or more tyres has dropped significantly. The wheel position appears in the multifunction display. A warning tone also sounds.</p> <p> WARNING</p> <p>Underinflated tyres pose the following risks:</p> <ul style="list-style-type: none"> • the tyres may burst, especially as the load and vehicle speed increase • the tyres may wear excessively and/or unevenly, which may greatly impair tyre traction • the driving characteristics, as well as steering and braking, may be greatly impaired <p>There is a risk of an accident.</p> <ul style="list-style-type: none"> ► Stop the vehicle without making any sudden steering or braking manoeuvres. Pay attention to the traffic conditions as you do so. ► Secure the vehicle against rolling away (▷ page 157). ► Check the tyres and, if necessary, follow the instructions for a flat tyre (▷ page 299). ► Check the tyre pressure (▷ page 322). ► If necessary, correct the tyre pressure.
<p>Warning tyre defect</p>	<p>The tyre pressure in one or more tyres has dropped suddenly. The wheel position appears in the multifunction display.</p> <p> WARNING</p> <p>If you drive with a flat tyre, there is a risk of the following hazards:</p> <ul style="list-style-type: none"> • a flat tyre impairs the ability to steer or brake the vehicle • you could lose control of the vehicle • continued driving with a flat tyre will cause excessive heat build-up and possibly a fire <p>There is a risk of an accident.</p> <ul style="list-style-type: none"> ► Stop the vehicle without making any sudden steering or braking manoeuvres. Pay attention to the traffic conditions as you do so. ► Secure the vehicle against rolling away (▷ page 157). ► Check the tyres and, if necessary, follow the instructions for a flat tyre (▷ page 299).
<p>Tyre press. monitor currently unavailable</p>	<p>No signals can be received from the tyre pressure sensors due to strong RF interference. The tyre pressure monitor is temporarily malfunctioning.</p> <ul style="list-style-type: none"> ► Drive on. The tyre pressure monitor starts automatically as soon as the cause has been rectified.







Display messages	Possible causes/consequences and ► Solutions
Wheel sensor(s) missing	<p>There is no signal from the tyre pressure sensor of one or several tyres. The pressure of the affected tyre is not displayed in the multifunction display.</p> <p>► Have the faulty tyre pressure sensor replaced at a qualified specialist workshop.</p>
Tyre press. monitor inoperative No wheel sensors	<p>The wheels fitted do not have suitable tyre pressure sensors. The tyre pressure monitor is deactivated.</p> <p>► Fit wheels with suitable tyre pressure sensors. The tyre pressure monitor is activated after driving for a few minutes.</p>
Tyre press. monitor inoperative	<p>The tyre pressure monitor is faulty.</p> <p>► Consult a qualified specialist workshop.</p>





Vehicle	
Display messages	Possible causes/consequences and ► Solutions
Depress brake to start engine	<p>You have attempted to start the engine with the transmission in position N without depressing the brake pedal.</p> <p>► Depress the brake pedal.</p>
To shift out of P or N, depress brake and start engine	<p>You have attempted to shift the transmission to position R or D without starting the engine.</p> <p>► Start the engine. ► Depress the brake pedal.</p> <p>i It is possible to shift the transmission from position P to the desired position only if you depress the brake pedal. Only then can the parking lock be deactivated. If you do not depress the brake pedal, the DIRECT SELECT lever can still be moved but the parking lock remains engaged.</p> <p>i At transmission fluid temperatures below -20 °C you can only shift out of position P into another transmission position when the engine is running.</p>
Apply brake to deselect Park (P) position	<p>You attempted to shift the transmission to position R, N or D without depressing the brake pedal.</p> <p>► Depress the brake pedal.</p>

Display messages	Possible causes/consequences and ► Solutions
Risk of vehicle rolling Transmission not in P	<p>The driver's door is open or not fully closed and the transmission is in position R, N or D.</p> <p>A warning tone also sounds.</p> <p> WARNING</p> <p>The vehicle may roll away. There is a risk of an accident.</p> <ul style="list-style-type: none"> ► Shift the transmission to position P. ► Secure the vehicle against rolling away (▷ page 157). ► Close the driver's door fully.
Without changing gear, consult workshop	<p>You cannot change the transmission position due to a malfunction. A warning tone also sounds.</p> <p>If transmission position D is selected:</p> <ul style="list-style-type: none"> ► Drive to a qualified specialist workshop without shifting the transmission from position D. <p>If position R, N or P is selected:</p> <ul style="list-style-type: none"> ► Secure the vehicle against rolling away (▷ page 157). ► Consult a qualified specialist workshop.
Only select Park (P) when vehicle is stationary	<p>The vehicle is moving.</p> <ul style="list-style-type: none"> ► Stop the vehicle, paying attention to road and traffic conditions. ► Shift the transmission to position P.
Apply brake to select R	<p>You have attempted to shift from position D or N to position R.</p> <ul style="list-style-type: none"> ► Shift the transmission to position R with the brake pedal depressed.
Reversing not possible. Consult workshop	<p>The automatic transmission is malfunctioning. You cannot drive in reverse.</p> <ul style="list-style-type: none"> ► Consult a qualified specialist workshop.
Transmission Malfunction	<p>The automatic transmission is malfunctioning.</p> <ul style="list-style-type: none"> ► Consult a qualified specialist workshop.
Transmission Malfunction Stop	<p>The automatic transmission is malfunctioning.</p> <ul style="list-style-type: none"> ► Stop the vehicle, paying attention to road and traffic conditions. ► Secure the vehicle against rolling away (▷ page 157). ► Consult a qualified specialist workshop.



Display messages	Possible causes/consequences and ► Solutions
<p>Stop vehicle Shift to P Leave engine running</p>	<p>The automatic transmission has overheated.</p> <ul style="list-style-type: none"> ► Drive on carefully. If the display message disappears, the automatic transmission is available again. <p>If the multifunction display still shows the display message:</p> <ul style="list-style-type: none"> ► Stop the vehicle, paying attention to road and traffic conditions. ► Secure the vehicle against rolling away (▷ page 157). ► Wait until the automatic transmission has cooled down and the display message goes out.
<p>Auxiliary battery malfunction</p>	<p>The auxiliary battery for the automatic transmission is no longer being charged.</p> <ul style="list-style-type: none"> ► Consult a qualified specialist workshop. ► Until then, always shift the transmission to position P before you switch off the engine. ► Before leaving the vehicle, apply the electric parking brake.
<p>Clutch overheated Avoid pulling away If necessary, quickly release and engage the clutch</p>	<p>The clutch is under considerable load and the permitted operating temperature has been exceeded. A warning tone also sounds. Avoid frequent pulling away and driving at walking pace over longer distances.</p> <ul style="list-style-type: none"> ► Stop the vehicle, paying attention to road and traffic conditions. ► Secure the vehicle against rolling away (▷ page 157). ► Leave the engine running. The clutch is cooled more quickly with the engine running. <p>or</p> <ul style="list-style-type: none"> ► If possible, drive on at a steady speed. ► Remove your foot from the clutch pedal and do not allow the clutch to slip. The clutch may also cool down during the journey. <p>It may take several minutes for it to cool down. When the clutch has cooled down, the display message disappears. The clutch is fully operational again.</p>
<p>Depress clutch fully to start engine</p>	<p>You attempted to start the engine without depressing the clutch pedal.</p> <ul style="list-style-type: none"> ► Depress the clutch pedal. ► Restart the engine. <p>The engine has stalled while pulling away, e.g. because the clutch pedal was released too quickly.</p> <ul style="list-style-type: none"> ► Depress the clutch pedal again. The engine starts automatically. ► Slowly release the clutch pedal to pull away.



Display messages	Possible causes/consequences and ► Solutions
Trans. oil overheated Drive on with care	<p>Mercedes-AMG vehicles: the transmission oil has overheated. Manual drive program M and the temporarily active manual drive program are no longer available. Engine power output is reduced.</p> <p>► Allow the vehicle to cool down.</p>
4matic currently unavailable	<p>4MATIC has overheated. The vehicle is only driven by the front wheels.</p> <p>► Drive on. The airflow cools 4MATIC more quickly.</p> <p>When the display message goes out, 4MATIC is available again and the vehicle is driven by all four wheels.</p>
4matic inoperative	<p>4MATIC is malfunctioning. The vehicle is only driven by the front wheels.</p> <p>► Consult a qualified specialist workshop.</p>
	<p>The tailgate is open</p> <p>⚠ WARNING</p> <p>When the engine is running, exhaust gases can enter the vehicle interior if the tailgate is open. There is a risk of poisoning.</p> <p>► Close the tailgate.</p>
	<p>The bonnet is open. A warning tone also sounds.</p> <p>⚠ WARNING</p> <p>The open bonnet may then block your view when the vehicle is in motion. There is a risk of an accident.</p> <p>► Stop the vehicle safely as soon as possible, paying attention to road and traffic conditions.</p> <p>► Secure the vehicle against rolling away (▷ page 157).</p> <p>► Close the bonnet.</p>
Active bonnet malfunction See Owner's Manual	<p>The active bonnet (pedestrian protection) is inoperative due to a malfunction or because it has already been triggered.</p> <p>► Consult a qualified specialist workshop.</p>
	<p>At least one door is open. A warning tone also sounds.</p> <p>► Close all doors.</p>

Display messages	Possible causes/consequences and ► Solutions
 <p>Check trailer hitch lock</p>	<p>The trailer tow hitch is not correctly engaged. A warning tone also sounds.</p> <p> WARNING</p> <p>If the ball coupling is not engaged, the trailer may come loose. There is a risk of an accident.</p> <ul style="list-style-type: none"> ► Stop the vehicle immediately, paying attention to road and traffic conditions, and switch off the engine. ► Secure the vehicle against rolling away (► page 157). ► Engage the ball coupling of the trailer tow hitch in the end position (► page 198).
 <p>inoperative Battery Low</p>	<p>The on-board voltage is too low The auxiliary heating has switched itself off or cannot be switched on (► page 128).</p> <ul style="list-style-type: none"> ► Drive for a considerable distance. The battery charges. The auxiliary heating is operational again as soon as the on-board electrical system voltage is sufficient.
 <p>inoperative Refuel vehicle</p>	<p>There is too little fuel in the fuel tank. The auxiliary heating cannot be switched on (► page 128).</p> <ul style="list-style-type: none"> ► Refuel at the nearest filling station.
 <p>inoperative See Owner's Man.</p>	<p>The auxiliary heating is temporarily malfunctioning or faulty.</p> <p>If the vehicle is on a level surface and the engine has cooled down:</p> <ul style="list-style-type: none"> ► Make up to four attempts to switch on the auxiliary heating, waiting several minutes between each attempt (► page 128). <p>If the auxiliary heating does not switch on:</p> <ul style="list-style-type: none"> ► Consult a qualified specialist workshop.
 <p>Power steering malfunction See Owner's Manual</p>	<p>The power steering assistance is faulty. A warning tone also sounds.</p> <p> WARNING</p> <p>You will need to use more force to steer. There is a risk of an accident.</p> <ul style="list-style-type: none"> ► Check whether you are able to apply the extra steering force required. <p>If you are able to steer safely:</p> <ul style="list-style-type: none"> ► Drive on carefully. ► Consult a qualified specialist workshop immediately. <p>If you are unable to steer safely:</p> <ul style="list-style-type: none"> ► Do not drive on. ► Consult a qualified specialist workshop.

Display messages	Possible causes/consequences and ► Solutions
 <p>Steering malfunction See Owner's Manual</p>	<p>The electric steering lock is malfunctioning.</p> <p> WARNING</p> <p>The steering may be locked by the electric steering lock. There is a risk of an accident.</p> <ul style="list-style-type: none"> ► Stop the vehicle safely as soon as possible, paying attention to road and traffic conditions. ► Secure the vehicle against rolling away (► page 157). ► Do not drive on. ► Consult a qualified specialist workshop.
 <p>Before starting the engine, turn the steering wheel.</p>	<p>The electric steering lock was unable to unlock the steering.</p> <ul style="list-style-type: none"> ► Remove the key from the ignition lock. ► To unlock the steering, move the steering wheel slightly. ► Insert the key into the ignition lock again.
<p>Telephone No service</p>	<p>Your vehicle is outside the mobile phone network provider's transmitter/receiver range.</p> <ul style="list-style-type: none"> ► Wait until the mobile phone operational readiness symbol appears on the multifunction display.
 <p>Top up washer fluid</p>	<p>The washer fluid level in the washer fluid reservoir has dropped below the minimum.</p> <ul style="list-style-type: none"> ► Top up the washer fluid (► page 288).
<p>Wiper malfunctioning</p>	<p>The windscreen wipers are defective.</p> <ul style="list-style-type: none"> ► Consult a qualified specialist workshop.
<p>Hazard warning lamps malfunctioning</p>	<p>The hazard warning lamps are faulty.</p> <ul style="list-style-type: none"> ► Consult a qualified specialist workshop.

Keys

Display messages	Possible causes/consequences and ► Solutions
 <p>Key does not belong to vehicle</p>	<p>You have put the wrong key in the ignition lock.</p> <ul style="list-style-type: none"> ► Use the correct key.
 <p>Replace key</p>	<p>The key needs to be replaced.</p> <ul style="list-style-type: none"> ► Consult a qualified specialist workshop.
 <p>Change key batteries</p>	<p>The key battery is discharged.</p> <ul style="list-style-type: none"> ► Change the battery (► page 79).

Display messages	Possible causes/consequences and ► Solutions
 <p>Key not detected (red display message)</p>	<p>The key is not in the vehicle. A warning tone also sounds. If the engine is switched off, you can no longer lock the vehicle centrally or start the engine.</p> <ul style="list-style-type: none"> ► Pull over and stop the vehicle safely as soon as possible, paying attention to road and traffic conditions. ► Secure the vehicle against rolling away (▷ page 157). ► Locate the key. <p>Because there is interference from a strong source of radio waves, the key is not detected whilst the engine is running. A warning tone also sounds.</p> <ul style="list-style-type: none"> ► Pull over and stop the vehicle safely as soon as possible, paying attention to road and traffic conditions. ► Secure the vehicle against rolling away (▷ page 157). ► Insert the key into the ignition lock and bring into key mode.
 <p>Key not detected (white display message)</p>	<p>The key is currently undetected.</p> <ul style="list-style-type: none"> ► Change the location of the key in the vehicle. <p>If the key still cannot be detected:</p> <ul style="list-style-type: none"> ► Operate the vehicle with the key in the ignition lock if necessary.
 <p>Remove starting button, then insert key</p>	<p>The key is continually undetected. The key detection function has a temporary malfunction or is faulty. A warning tone also sounds.</p> <ul style="list-style-type: none"> ► Insert the key into the ignition lock and turn it to the desired position. ► Consult a qualified specialist workshop.

Warning and indicator lamps on the instrument cluster





General notes

Some systems perform a self test when the ignition is switched on. Some warning and indicator lamps may temporarily switch on or flash during the test. This behaviour is nothing to be concerned about.

The warning and indicator lamps will alert you to a malfunction if they switch on or flash after the engine is started or while driving.

Safety

Seat belts

Warning/ indicator lamp	▷ Signal type Possible causes/consequences and ▶ Solutions
	<p>▷ Only for certain countries: the red seat belt warning lamp lights up for six seconds after the engine starts.</p> <p>The seat belt warning lamp reminds the driver and front passenger to fasten their seat belts.</p> <p>▶ Fasten your seat belt (▷ page 44).</p>
	<p>▷ For certain countries only: the red seat belt warning lamp lights up after the engine starts. In addition, a warning tone sounds for up to six seconds.</p> <p>The driver's seat belt is not fastened.</p> <p>▶ Fasten your seat belt (▷ page 44). The warning tone ceases.</p>
	<p>▷ The red seat belt warning lamp lights up after the engine starts, as soon as the driver's or the front-passenger door is closed.</p> <p>The driver or passenger has not fastened their seat belt.</p> <p>▶ Fasten your seat belt (▷ page 44). The warning lamp goes out.</p> <p>There are objects on the front-passenger seat.</p> <p>▶ Remove the objects from the front-passenger seat and stow them in a secure place. The warning lamp goes out.</p>
	<p>▷ The red seat belt warning lamp flashes and an intermittent audible warning sounds.</p> <p>The driver or passenger has not fastened their seat belt. At the same time, you are driving faster than 25 km/h or have briefly driven faster than 25 km/h.</p> <p>▶ Fasten your seat belt (▷ page 44). The warning lamp goes out and the intermittent warning tone ceases.</p> <p>There are objects on the front-passenger seat. At the same time, you are driving faster than 25 km/h or have briefly driven faster than 25 km/h.</p> <p>▶ Remove the objects from the front-passenger seat and stow them in a secure place. The warning lamp goes out and the intermittent warning tone ceases.</p>

Safety systems

Warning/
indicator
lamp

▷ Signal type

Possible causes/consequences and ► Solutions



▷ The red brake system warning lamp is lit while the engine is running. A warning tone also sounds.

WARNING

The brake boosting effect is malfunctioning and the braking characteristics may be affected.

There is a risk of an accident.

- ▶ Stop the vehicle safely as soon as possible, paying attention to road and traffic conditions. Do not drive on.
- ▶ Secure the vehicle against rolling away (▷ page 157).
- ▶ Consult a qualified specialist workshop.
- ▶ Observe the additional display messages on the multifunction display.



▷ The red brake system warning lamp is lit while the engine is running. A warning tone also sounds.

There is insufficient brake fluid in the brake fluid reservoir.

WARNING

Braking efficiency may be impaired.

There is a risk of an accident.

- ▶ Stop the vehicle safely as soon as possible, paying attention to road and traffic conditions. Do not drive on.
- ▶ Secure the vehicle against rolling away (▷ page 157).
- ▶ Do not top up the brake fluid. Topping up will not correct the fault.
- ▶ Consult a qualified specialist workshop.
- ▶ Observe the additional display messages on the multifunction display.

**Warning/
indicator
lamp****▷ Signal type****Possible causes/consequences and ▶ Solutions**

▷ The yellow ABS warning lamp is lit while the engine is running.

ABS (Anti-lock Braking System) has been deactivated due to a fault. BAS (Brake Assist), Active Brake Assist, ESP® (Electronic Stability Program), ESP® trailer stabilisation, the HOLD function, hill start assist, the adaptive brake lights and PRE-SAFE® are also therefore deactivated, for example.

ATTENTION ASSIST is deactivated.

 **WARNING**

The brake system continues to function normally, but without the functions listed above. The wheels could therefore lock if you brake hard, for example.

The steerability and braking characteristics may be severely affected. The braking distance may increase in an emergency braking situation.

If ESP® is not operational, ESP® is unable to stabilise the vehicle.

There is an increased risk of skidding and/or accident.

- ▶ Observe the additional display messages on the multifunction display.
- ▶ Drive on carefully.
- ▶ Consult a qualified specialist workshop immediately.

If the ABS control unit is faulty, there is also a possibility that other systems, such as the navigation system or the automatic transmission, will be unavailable.

Warning/
indicator
lamp▷ Signal type
Possible causes/consequences and ▶ Solutions

▷ The yellow ABS warning lamp is lit while the engine is running.

ABS is temporarily unavailable. Therefore, BAS, Active Brake Assist, ESP®, ESP® trailer stabilisation, EBD (electronic brake force distribution), the HOLD function, hill start assist, the adaptive brake lights and PRE-SAFE®, for example, are also deactivated.

Possible causes:

- self-diagnosis is not yet complete
- the on-board voltage may be insufficient

ATTENTION ASSIST is deactivated.

 **WARNING**

The brake system continues to function normally, but without the functions listed above. The front and rear wheels could therefore lock if you brake hard, for example.

The steerability and braking characteristics may be severely affected. The braking distance may increase in an emergency braking situation.

If ESP® is not operational, ESP® is unable to stabilise the vehicle.

There is a risk of an accident.

- ▶ Carefully drive on a suitable stretch of road, making slight steering movements at a speed above 20 km/h.
The functions mentioned above are available again when the warning lamp goes out.

If the warning lamp is still on:

- ▶ Observe the additional display messages on the multifunction display.
- ▶ Drive on carefully.
- ▶ Consult a qualified specialist workshop immediately.

Warning/
indicator
lamp▷ Signal type
Possible causes/consequences and ► Solutions

▷ The yellow ABS warning lamp is lit while the engine is running. A warning tone also sounds.

EBD is faulty. Therefore, ABS, BAS, Active Brake Assist, ESP®, ESP® trailer stabilisation, the HOLD function, hill start assist, the adaptive brake lights and PRE-SAFE®, for example, are not available either.

ATTENTION ASSIST is deactivated.

WARNING

The brake system continues to function normally, but without the functions listed above. The front and rear wheels could therefore lock if you brake hard, for example.

The steerability and braking characteristics may be severely affected. The braking distance may increase in an emergency braking situation.

If ESP® is not operational, ESP® is unable to stabilise the vehicle.

There is an increased risk of skidding and/or accident.

- ▶ Observe the additional display messages on the multifunction display.
- ▶ Drive on carefully.
- ▶ Consult a qualified specialist workshop immediately.



▷ The red brake system warning lamp and the yellow ABS, ESP® and ESP® OFF warning lamps are lit while the drive system is running.

ABS and ESP® are malfunctioning. Therefore, BAS, Active Brake Assist, EBD, PRE-SAFE®, the HOLD function, hill start assist, the adaptive brake lights and ESP® trailer stabilisation, for example, are also unavailable.

ATTENTION ASSIST is deactivated.

WARNING

The brake system continues to function normally, but without the functions listed above. The front and rear wheels could therefore lock if you brake hard, for example.

The steerability and braking characteristics may be severely affected. The braking distance may increase in an emergency braking situation.

If ESP® is not operational, ESP® is unable to stabilise the vehicle.

There is an increased risk of skidding and/or accident.

- ▶ Observe the additional display messages on the multifunction display.
- ▶ Drive on carefully.
- ▶ Consult a qualified specialist workshop immediately.

**Warning/
indicator
lamp****▷ Signal type****Possible causes/consequences and ► Solutions**

▷ The yellow ESP® warning lamp flashes while the vehicle is in motion. ESP® or traction control has intervened due to a risk of skidding or because at least one wheel has started to spin.

Cruise control or Distance Pilot DISTRONIC is deactivated.

- ▶ Depress the accelerator pedal only as far as necessary when pulling away.
- ▶ Accelerate more gently while the vehicle is in motion.
- ▶ Adapt your driving style to suit the road and weather conditions.
- ▶ Do not deactivate ESP®.

In rare cases – (▷ page 71) – it may be best to deactivate ESP®.

Observe the important safety notes on ESP® (▷ page 69).



▷ The yellow ESP® OFF warning lamp is lit while the engine is running.

ESP® is deactivated. ESP® will not stabilise the vehicle if it starts to skid or if a wheel starts to spin.

⚠ WARNING

If ESP® is deactivated, ESP® is unable to stabilise the vehicle.

Further driving systems or driving safety systems are thus restricted.

There is an increased risk of skidding and/or accident.

- ▶ Reactivate ESP®.

In rare cases (▷ page 71) it may be better to deactivate ESP®.

Observe the important safety notes on ESP® (▷ page 69).

- ▶ Adapt your driving style to suit the road and weather conditions.

If ESP® cannot be activated:

- ▶ Drive on carefully.
- ▶ Consult a qualified specialist workshop immediately and have the ESP® system checked.



▷ Mercedes-AMG vehicles only:

The yellow SPORT handling mode warning lamp is lit while the engine is running.

SPORT handling mode is activated.

⚠ WARNING

When SPORT handling mode is activated, ESP® is unable to stabilise the vehicle.

There is an increased risk of skidding and/or accident.

- ▶ Only switch to SPORT handling mode in accordance with the conditions described in the "Deactivating/activating ESP®" section (▷ page 71).

**Warning/
indicator
lamp****▷ Signal type****Possible causes/consequences and ▶ Solutions**

▷ The yellow ESP® and ESP® OFF warning lamps are lit while the engine is running. ESP®, ESP® trailer stabilisation, BAS, Active Brake Assist, the HOLD function, hill start assist, the adaptive brake lights and PRE-SAFE® are not available due to a malfunction.

ATTENTION ASSIST is deactivated.

WARNING

The brake system continues to function normally, but without the functions listed above.

The braking distance may thus increase in an emergency braking situation.

If ESP® is not operational, ESP® is unable to stabilise the vehicle.

There is an increased risk of skidding and/or accident.

- ▶ Observe the additional display messages on the multifunction display.
- ▶ Drive on carefully.
- ▶ Consult a qualified specialist workshop immediately.



▷ The yellow ESP® and ESP® OFF warning lamps are lit while the engine is running. ESP®, ESP® trailer stabilisation, BAS, the HOLD function, hill start assist and PRE-SAFE® are temporarily unavailable.

Adaptive brake lights and Active Brake Assist may have also failed.

ATTENTION ASSIST is deactivated.

self-diagnosis is not yet complete

WARNING

The brake system continues to function normally, but without the functions listed above.

The braking distance may thus increase in an emergency braking situation.

If ESP® is not operational, ESP® is unable to stabilise the vehicle.

There is an increased risk of skidding and/or accident.

- ▶ Carefully drive on a suitable stretch of road, making slight steering movements at a speed above 20 km/h.
The functions mentioned above are available again when the warning lamp goes out.

If the warning lamp is still on:

- ▶ Observe the additional display messages on the multifunction display.
- ▶ Drive on carefully.
- ▶ Consult a qualified specialist workshop immediately.

**Warning/
indicator
lamp****▷ Signal type
Possible causes/consequences and ► Solutions**

▷ The red indicator lamp for the electric parking brake flashes or is lit and/or the yellow warning lamp for the electric parking brake is lit.

► Observe the additional display messages on the multifunction display.



▷ The red restraint system warning lamp is lit while the engine is running. The restraint system is malfunctioning.

⚠ WARNING

The airbags or belt tensioners may either be triggered unintentionally or, in the event of an accident, may not be triggered.

This poses an increased risk of injury.

- Observe the additional display messages on the multifunction display.
- Drive on carefully.
- Consult a qualified specialist workshop immediately and have the restraint system checked.

Further information about the restraint system (▷ page 40).

Engine**Warning/
indicator
lamp****▷ Signal type
Possible causes/consequences and ► Solutions**

▷ The yellow engine diagnostics warning lamp lights up while the engine is running.

There may be a fault with the following, for example:

- Engine management
- Fuel injection system
- Exhaust system
- Ignition system (for vehicles with petrol engines)
- Fuel system

The emission limit values may be exceeded and the engine may be running in emergency mode.

- Consult a qualified specialist workshop immediately.

Vehicles with a diesel engine: the fuel tank has been run dry (▷ page 156).

- Start the engine three to four times after refuelling.
If the yellow engine diagnostics warning lamp goes out, emergency mode is cancelled. The vehicle does not have to be checked.



▷ The yellow reserve fuel warning lamp lights up while the engine is running. The fuel level has dropped into the reserve range.

Operation of the auxiliary heating is deactivated if the fuel level drops into the reserve range.

- Refuel at the nearest filling station.

**Warning/
indicator
lamp****▷ Signal type****Possible causes/consequences and ▶ Solutions**

▷ The red coolant warning lamp lights up while the engine is running and the coolant temperature gauge is at the start of the scale. The temperature sensor for the coolant temperature gauge is malfunctioning. The coolant temperature is no longer being monitored. The engine could be damaged if the coolant temperature is too high.

- ▶ Stop the vehicle immediately, paying attention to road and traffic conditions, and switch off the engine. Do not continue driving.
- ▶ Secure the vehicle against rolling away (▷ page 157).
- ▶ Consult a qualified specialist workshop.

Warning/
indicator
lamp

▷ Signal type

Possible causes/consequences and ► Solutions



▷ The red coolant warning lamp lights up while the engine is running.

The coolant level is too low.

If the coolant level is correct, the airflow to the engine radiator may be blocked or the electric engine radiator fan may be malfunctioning.

The coolant is too hot and the engine is not being cooled sufficiently.

- ▶ Observe the additional display messages in the multifunction display.
- ▶ Stop the vehicle immediately, paying attention to road and traffic conditions, and switch off the engine.
- ▶ Secure the vehicle against rolling away (▷ page 157).
- ▶ Leave the vehicle and keep a safe distance from the vehicle until the engine has cooled down.
- ▶ Check the coolant level and top up the coolant, making sure to observe the warning notes (▷ page 288).
- ▶ If you have to top up the coolant frequently, have the engine cooling system checked.
- ▶ Make sure that the air supply to the engine radiator is not blocked, e.g. by frozen slush.
- ▶ Do not start the engine again until the coolant temperature is below 120 °C. The engine may otherwise be damaged.
- ▶ Drive to the nearest qualified specialist workshop.
- ▶ Avoid heavy loads on the engine as you do so, e.g. driving in mountainous terrain and stop-start traffic.



▷ The red coolant warning lamp lights up while the engine is running. A warning tone also sounds.

The coolant temperature has exceeded 120 °C. The airflow to the engine radiator may be blocked or the coolant level may be too low.

WARNING

The engine is not being cooled sufficiently and may be damaged.

Never drive with an overheated engine. Driving when your engine has overheated can cause any fluids that may have leaked into the engine compartment to catch fire.

In addition, steam from an overheated engine can cause serious burns, which can occur just by opening the bonnet.

There is a risk of injury.

- ▶ Observe the additional display messages in the multifunction display.
- ▶ Stop the vehicle immediately, paying attention to road and traffic conditions, and switch off the engine.
- ▶ Secure the vehicle against rolling away (▷ page 157).
- ▶ Leave the vehicle and keep a safe distance from the vehicle until the engine has cooled down.
- ▶ Check the coolant level and top up the coolant, making sure to observe the warning notes (▷ page 288).
- ▶ If you have to top up the coolant frequently, have the engine cooling system checked.

**Warning/
indicator
lamp****▷ Signal type****Possible causes/consequences and ► Solutions**

- ▶ Make sure that the air supply to the engine radiator is not blocked, e.g. by frozen slush.
- ▶ If the coolant temperature is below 120 °C, you can continue driving to the nearest qualified specialist workshop.
- ▶ Avoid heavy loads on the engine as you do so, e.g. driving in mountainous terrain and stop-start traffic.

Driving systems**Warning/
indicator
lamp****▷ Signal type****Possible causes/consequences and ► Solutions**

- ▷ The red distance warning lamp lights up while the vehicle is in motion. The distance to the vehicle in front is too small for the speed selected.
- ▶ Increase the distance.



- ▷ The red distance warning lamp lights up while the vehicle is in motion. A warning tone also sounds. You are approaching a vehicle or a stationary obstacle in your line of travel at too high a speed.
- ▶ Be prepared to brake immediately.
- ▶ Pay careful attention to the traffic situation. You may have to brake or take evasive action.

Further information on the distance warning function of Active Brake Assist (▷ page 66).

Tyres

Warning/
indicator
lamp

▷ Signal type

Possible causes/consequences and ► Solutions



▷ The yellow tyre pressure monitor warning lamp (pressure loss/malfunction) is lit.

The tyre pressure monitor has detected a loss of pressure in at least one of the tyres.

 **WARNING**

Underinflated tyres pose the following risks:

- the tyres may burst, especially as the load and vehicle speed increase
- the tyres may wear excessively and/or unevenly, which may greatly impair tyre traction
- the driving characteristics, as well as steering and braking, may be greatly impaired

There is a risk of an accident.

- ▶ Stop the vehicle without making any sudden steering or braking manoeuvres. Pay attention to the traffic conditions as you do so.
- ▶ Safeguard the vehicle against rolling away (▷ page 157).
- ▶ Observe the additional display messages in the multifunction display.
- ▶ Check the tyres and, if necessary, follow the instructions for a flat tyre (▷ page 299).
- ▶ Check the tyre pressure (▷ page 322).
- ▶ If necessary, correct the tyre pressure.



▷ The yellow tyre pressure monitor warning lamp (pressure loss/malfunction) flashes for approximately one minute and then remains lit.

The tyre pressure monitor is faulty.

 **WARNING**

The system is possibly unable to detect or register low tyre pressure.

There is a risk of an accident.

- ▶ Observe the additional display messages in the multifunction display.
- ▶ Consult a qualified specialist workshop immediately.

General notes

The section on the multimedia system in this manual describes the basic principles for operation. More information can be found in the Digital Owner's Manual.

Important safety notes

WARNING

If you operate information and communication equipment integrated in the vehicle when driving, you could be distracted from the traffic situation. This could also cause you to lose control of the vehicle. There is a risk of an accident.

Only operate this equipment when the traffic situation permits. If you cannot be sure of this, stop the vehicle paying attention to road and traffic conditions and operate the equipment with the vehicle stationary.

You must observe the legal requirements for the country in which you are currently driving when operating the multimedia system.

The multimedia system calculates the route to the destination without taking the following into account, for example:

- traffic lights
- stop and give way signs
- parking or stopping restrictions
- road narrowing
- other road and traffic rules and regulations

The multimedia system may give incorrect driving recommendations if the actual road/traffic situation does not correspond with the digital map data.

For example:

- a diverted route
- the road layout or the direction of a one-way street has been changed

For this reason, you must always observe road and traffic rules and regulations during your journey. Road and traffic rules and regulations always have priority over multimedia system driving recommendations.

WARNING

Modifications to electronic components, their software as well as wiring could affect their function and/or the operation of other networked components. This could in particular also be the case for systems relevant to safety. They might not function properly anymore and/or jeopardise the operational safety of the vehicle. There is an increased risk of an accident and injury.

Do not attempt to modify the wiring as well as electronic components or their software. Always have work on electrical and electronic components carried out at a qualified specialist workshop.

If you make any changes to the vehicle electronics, the general operating permit is rendered invalid.

Function restrictions

For safety reasons, some functions are restricted or unavailable while the vehicle is in motion. You will notice this, for example, because either you will not be able to select certain menu items or a message will appear to this effect.

Operating system

Overview

General notes

! Do not use the space in front of the display for storage. Objects placed here could damage the display or impair its function. Avoid any direct contact with the display surface. Pressure on the display surface may result in impairments to the display, which could be irreversible.

Wearing polarised sunglasses may impair your ability to read the display.

The display has an automatic temperature-controlled switch-off feature. The brightness is automatically reduced if the temperature is too high. If necessary, the display may temporarily switch off completely.

Cleaning instructions

! Do not touch the display. The display has a very sensitive high-gloss surface; there is a risk of scratching. If you have to clean the screen, however, use a mild cleaning agent and a soft, lint-free cloth.

The display must be switched off and have cooled down before you start cleaning. Do not apply pressure to the display surface when cleaning it, as this could cause irreversible damage to the display.

Switching the multimedia system on/off

► Press the  control knob.



Adjusting the volume

► Turn the  control knob.

The volume changes:

- for the currently set media source
- during a traffic announcement or navigation message
- in hands-free mode during an active call

Switching the sound on/off

► Press the  button on the control panel. If the audio output is switched off, the status line will show the  symbol. If you switch the media source or change the volume, the sound is automatically switched on.

i You will hear navigation messages even when the sound is muted.

Functions

The multimedia system has the following functions:





- Radio mode
- Media mode with media search
- Sound systems
- Navigation system
 - COMAND Online: navigation using hard drive
 - Audio 20: navigation using SD memory card
- Communication functions
- Vehicle functions with system settings
- Favourites functions

Controller

The controller in the centre console lets you:

- select menu items on the display
- enter characters
- select a destination on the map
- save entries

The controller can be:

- turned 
- slid left or right 
- slid forwards or back 
- slid diagonally 
- pressed briefly or pressed and held 

Back button

You can use the  button to exit a menu or to call up the main menu of the current operating mode.

► **To exit the menu:** briefly press the  button.

The multimedia system changes to the next higher menu level in the current operating mode.

► **To call up the main menu:** press the  button for longer than two seconds.

The multimedia system changes to the main menu of the current operating mode.

Favourites button

You can store predefined functions using the  favourites button and call them up at the press of a button (► page 262).

Favourites

Calling up and exiting favourites







► **To call up:** press the  button on the controller.

► Select a favourite, e.g. **Vehicle**. The favourites are displayed.

► **To exit:** press the  button again.

Adding favourites

Adding predefined favourites

- ▶ Press the  button.
- ▶ **COMAND Online:** slide  the controller.
- ▶ **Audio 20:** slide  or  the controller. The menu bar is displayed.
- ▶ Select **Reassign**. The categories are displayed.
- ▶ Select a category. The favourites are displayed.
- ▶ Select a favourite.
- ▶ **COMAND Online:** to add the favourite to the desired position, turn and press the controller. If a favourite has already been added at this position, it will be overwritten.
- ▶ **Audio 20:** to add the favourite to the desired position, turn, slide  or  and press the controller. If a favourite has already been added at this position, it will be overwritten.

Adding your own favourites

You can add climate control as a favourite, for example.

- ▶ Select **Vehicle** → **Vehicle settings**.
- ▶ Press and hold the  button until the favourites are displayed.
- ▶ Add a favourite to the desired position. If a favourite has already been added at this position, it will be overwritten.

Navigation mode

Important safety notes

WARNING

If you operate information and communication equipment integrated in the vehicle when driving, you could be distracted from the traffic situation. This could also cause you to lose control of the vehicle. There is a risk of an accident.

Only operate this equipment when the traffic situation permits. If you cannot be sure of this, stop the vehicle paying attention to road and

traffic conditions and operate the equipment with the vehicle stationary.

You must observe the legal requirements for the country in which you are currently driving when operating the navigation system.

General notes

Correct functioning of the navigation system depends, amongst other things, on GPS reception. In certain situations, GPS reception may be impaired, there may be interference or there may be no reception at all, e.g. in tunnels or multi-storey car parks.

Audio 20 is equipped with Garmin® MAP PILOT (see the manufacturer's operating instructions). The Garmin® MAP PILOT operating instructions are stored on the SD card as a PDF file. The SD card box contains a quick guide.

The following descriptions apply to navigation with COMAND Online. Further information can be found in the Digital Owner's Manual.

Selecting a route type and route options

Multimedia system:

- ▶ Select **Navi** → **Navigation**. The map displays the current vehicle position.
- ▶ Slide  the controller.
- ▶ Select **Options** → **Route settings**.

Notes for route types:

- **Eco route**
- **Dynamic route**

Traffic reports on the route for the route guidance are taken into account (not available in all countries).

- **Dynamic route only after request**

You can decide whether or not current traffic reports should be included in the route calculation (not available in all countries).

- **Calculate alternative routes**

Different routes are being calculated. In order to do so, instead of **Start**, select the menu item **Continue**.

- ▶ **To avoid/use route options:** select **Avoid options**.
- ▶ Select a route option.

Notes for route options:

- **Use toll roads**

The route calculation includes roads which require you to pay a usage fee (toll).

- Use **vignette roads** (not available in all countries)



The route calculation includes roads which require you to pay a time-based fee (vignette). A vignette allows temporary use of the route network, e.g. 10 days or 1 year.

Entering an address

Multimedia system:

- ▶ Select **Navi** → **Navigation**.
The map displays the current vehicle position.
- ▶ Slide  the controller.
- ▶ Select **Destination** → **Address entry**.

Enter an address, e.g. as follows:

- town or postcode, street, house number
- country, town or postcode
- town or postcode, centre
- street, town or postcode, junction
- ▶ Select **Town**.
The town in which the vehicle is currently located (current vehicle position) is at the top. Below this, you will see locations for which route guidance has already been carried out.
- ▶ Enter the town.
The  symbol: the location is contained on the digital map multiple times.
- ▶ **To switch to the list:** slide  the controller.
- ▶ Select the location.
If available, the postcode is shown. If there are different postcodes available for the location, the corresponding digits are displayed with an **X**.
- ▶ Enter the street and house number.
The address is in the menu.

Further options for destination entry:

- search for a keyword
The keyword search finds destinations using fragments of words.
- select the last destination
- select a contact
- select a POI
You can search for a POI by location, name or telephone number.
- select destination on the map
- enter intermediate destination

You can map the route to the destination yourself with up to four intermediate destinations.

- select travel guide destination (only available for selected European countries)
- select destinations from Mercedes-Benz Apps
- select geo-coordinates

Calculating the route

Requirement: the address has been entered and is in the menu.

- ▶ Select **Start** or **Continue**.
The route is calculated with the selected route type and the selected route options.
If route guidance has already been activated, a prompt will appear asking whether you wish to end the current route guidance.
- ▶ Select **Cancel current route guidance** or **Set as intermediate destination**.
Cancel current route guidance cancels the current route guidance and starts route calculation to the new destination.
Set as intermediate destination adds the new destination in addition to the existing destination and opens the intermediate destinations list.

Connecting a mobile phone (COMAND Online)

Requirements

For telephony via the Bluetooth® interface, a Bluetooth®-capable mobile phone is required. The mobile phone must support Hands-Free Profile 1.0 or above.

Multimedia system:

- ▶ Select **Vehicle** → **System settings** → **Activate Bluetooth**.
- ▶ Activate Bluetooth® .

Mobile phone:

- ▶ Activate Bluetooth® and, if necessary, Bluetooth® visibility for other devices (see the manufacturer's operating instructions).

The Bluetooth® device names for all of one manufacturer's products might be identical. To make it possible to clearly identify your mobile

phone, change the device name (see the manufacturer's operating instructions).

If the mobile phone supports the PBAP (**Phone Book Access Profile**) and MAP (**Message Access Profile**) Bluetooth® profiles, the following information will be transmitted after you connect:

- Phone book
- Call lists
- Text messages and e-mails

i Further information on suitable mobile phones can be found at: <http://www.mercedes-benz.com/connect>

Searching for and authorising (connecting) a mobile phone

Before using your mobile phone with the multimedia system for the first time, you will need to search for the phone and then authorise (connect) it. Depending on the mobile phone, authorisation takes place by means of Secure Simple Pairing or by entering a passkey. The multimedia system automatically makes the procedure that is relevant for your mobile phone available. The mobile phone is always connected automatically after authorisation. Further information on using a mobile phone with the multimedia system (see the Digital Owner's Manual).

If the multimedia system does not detect your mobile phone, this may be due to particular security settings on your mobile phone (see the manufacturer's operating instructions).

Only one mobile phone can be connected to the multimedia system at any one time.



Searching for a mobile phone

Multimedia system:

- ▶ Select **Tel/**  → **Connect device** → **Search for phones** → **Start search**.

The available mobile phones are displayed.

Symbols in the device list

Symbol	Explanation
	New mobile phone found, not yet authorised.
	Mobile phone is authorised, but is not connected.

Connecting the mobile phone

Authorisation using Secure Simple Pairing:

- ▶ Select the mobile phone.
A code is displayed in the multimedia system and on the mobile phone.
- ▶ **If codes match:** select **Yes** on the multimedia system.
- ▶ Confirm the code on the mobile phone.
Depending on the mobile phone used, confirm the connection to the multimedia system and for the PBAP and MAP Bluetooth® profiles. The prompt to confirm may take up to two minutes to be displayed (see the manufacturer's operating instructions).
- ▶ **If the codes are different:** select **No** on the multimedia system.
The process is cancelled.
Repeat authorisation.

Authorisation by entering a passkey (passcode):

- ▶ Select the Bluetooth® name of the mobile phone.
The input menu for the passkey is displayed.
- ▶ Choose a one to sixteen-digit number combination as a passkey.
- ▶ Enter the passkey on the multimedia system.
- ▶ Press **ok** to confirm.
- ▶ Enter and confirm the passkey on the mobile phone. Depending on the mobile phone used, confirm the connection to the multimedia system and for the PBAP and MAP Bluetooth® profiles. The prompt to confirm may take up to two minutes to be displayed (see the manufacturer's operating instructions).

i Mobile phones that are connected to the optionally available telephone module with Bluetooth® (SAP profile) are displayed separately in the device list. These are found below the entry **MB SAP module phones**.

Connecting a mobile phone (Audio 20)

Requirements

For telephony via the Bluetooth® interface, you require at least one Bluetooth®-capable mobile phone depending on use of **one-telephone mode** or **two-telephone mode**. The mobile phone must support Hands-Free Profile 1.0 or above.

In **two-telephone mode** you can use all the functions of the multimedia system with the **main telephone**. With the **additional telephone**, you can receive incoming calls.

Multimedia system:

- ▶ Select **Vehicle** → **System settings** → **Activate Bluetooth**.
- ▶ Activate Bluetooth® .

Mobile phone:

- ▶ Activate Bluetooth® and, if necessary, Bluetooth® visibility for other devices (see the manufacturer's operating instructions).

The Bluetooth® device names for all of one manufacturer's products might be identical. To make it possible to clearly identify your mobile phone, change the device name (see the manufacturer's operating instructions).

If the mobile phone supports the PBAP (Phone Book Access Profile) and MAP (Message Access Profile) Bluetooth® profiles, the following information is transmitted after you connect the main telephone:

- Phone book
- Call lists
- Text messages and e-mails

i Further information on suitable mobile phones can be found at: **http://www.mercedes-benz.com/connect**

Searching for and authorising (connecting) a mobile phone

Before using your mobile phone with the multimedia system for the first time, you will need to search for the phone and then authorise (connect) it. Depending on the mobile phone, authorisation takes place by means of Secure Simple Pairing or by entering a passkey. The multimedia system automatically makes the procedure that is relevant for your mobile phone available. The mobile phone is always connected automatically after authorisation. Further information on using a mobile phone with the multimedia system (see the Digital Owner's Manual).

If the multimedia system does not detect your mobile phone, this may be due to particular security settings on your mobile phone (see the manufacturer's operating instructions).

Searching for a mobile phone

Multimedia system:

- ▶ Select **Tel/**  → **Connect device** → **Connect new device**.
- ▶ Select **Connect via vehicle**.
- ▶ Select the mobile phone.

Connecting the mobile phone

- ▶ **One-telephone mode:** select **Connect as new main phone**.
- ▶ **Two-telephone mode:** select **Connect as additional phone** when a mobile phone is already connected.
- ▶ **Authorisation using Secure Simple Pairing:**

A code is displayed in the multimedia system and on the mobile phone.





- ▶ Confirm the code on the mobile phone. Depending on the mobile phone used, confirm the connection to the multimedia system and for the PBAP and MAP Bluetooth® profiles. The prompt to confirm may take up to two minutes to be displayed (see the manufacturer's operating instructions).
- ▶ If the codes are different: select **No** on the multimedia system. The process is cancelled. Repeat authorisation.

or

- ▶ **Authorisation by entering a passkey (passcode):** enter any one- to sixteen-digit number sequence which you have chosen yourself.
- ▶ Press **OK** to confirm.
- ▶ Enter and confirm the passkey on the mobile phone. Depending on the mobile phone used, confirm the connection to the multimedia system and for the PBAP and MAP Bluetooth® profiles. The prompt to confirm may take up to two minutes to be displayed (see the manufacturer's operating instructions).

Symbols in the device manager

The symbols are shown in colour depending on their use.

Symbol	Explanation
	Mobile phone connected to the multimedia system
	SAP telephone is connected to the multimedia system
	Main telephone with full range of functions SAP telephone
	Additional telephone for incoming calls in two-telephone mode

Telephone module with Bluetooth® (SAP profile)

Introduction

The module can be used as a permanently installed telephone with its own SIM card (▷ page 268) or in conjunction with a mobile phone (▷ page 268).

If you wish to use the module in conjunction with your mobile telephone, the mobile phone must support the Bluetooth® SAP profile (SIM Access Profile).

The following functions are available using the module:

- hands-free mode
- data modem mode (▷ page 269)
- sending and receiving text messages (▷ page 269)
- access to the phone book of the mobile phone (if supported by the mobile phone) (▷ page 269)
- charging a mobile phone via the USB port (▷ page 269)

i The module is not available in all vehicles, depending on the equipment.

Installing the module



▶ Slide module ② into bracket ① until it audibly engages.

Connecting the module via a USB cable (COMAND Online)

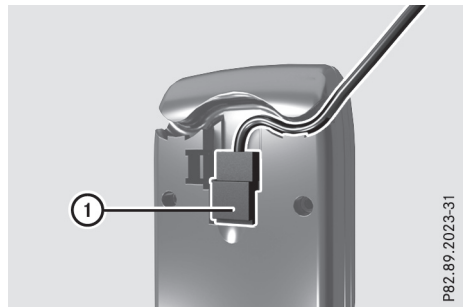

Mounting the module in the stowage compartment of the centre console

- ▶ Insert USB cable ① into the module.
- ▶ Slide the module into the bracket until it audibly engages.
- ▶ Connect the USB cable to the USB port.

Activating and connecting the module

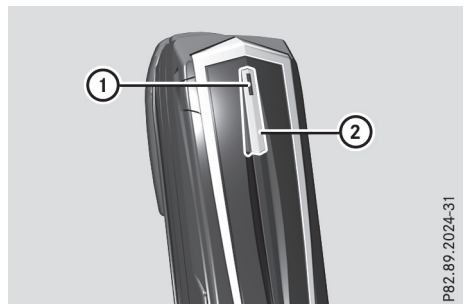

P82.89.2022-31

P82.89.2023-31

P82.89.2024-31

Multimedia system:

- ▶ Select **Tel/** .
- ▶ **Module:** install (▷ page 267).
- ▶ Press and hold button **2**.
- ▶ As soon as indicator lamp **1** starts flashing yellow, release the button.
The indicator lamp continues to flash yellow.

COMAND Online:

- ▶ Select **Connect device** → **Connect MB SAP module** → **Start search**.
The module is searched for and connected.
- ▶ **To authorise a mobile phone:** select **Start search** and follow the instructions of the multimedia system. Further information on authorising and connecting mobile phones (▷ page 265).

Audio 20:

- ▶ Select **Connect device** → **Connect MB SAP module** → **Connect via vehicle**.
The telephone module is automatically connected.
You can now connect a mobile phone to the telephone module.
Further information on authorising and connecting mobile phones (▷ page 265).

SIM card mode

Inserting a SIM card

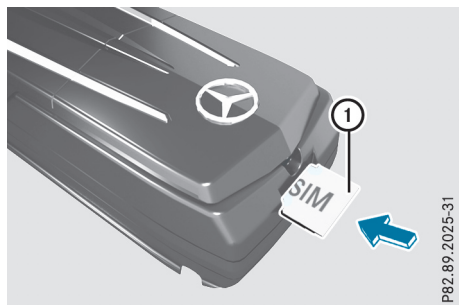

PB2.89.2025-31

- ▶ With the contact surface facing down, insert SIM card **1** into the SIM card slot until it engages.
After a SIM card is inserted in the module, a Bluetooth® connection with another mobile phone is no longer possible. Any existing Bluetooth® connection is ended upon SIM card insertion.

Connecting the mobile phone

General notes

Before using your mobile phone with the module and the multimedia system for the first time, you will need to search for the phone and then authorise it.

Requirements

The mobile phone can be authorised and connected to the module if:

- the module is installed (▷ page 267) and activated in the multimedia system (▷ page 267)
- no SIM card is inserted in the module
- the mobile phone has no active Bluetooth® connection to another device
- the mobile phone supports the Bluetooth® SAP profile (**SIM Access Profile**)

Depending on the type of mobile phone, different settings must be changed on the mobile phone (see the manufacturer's operating instructions).

- Bluetooth® must be activated on the mobile phone and must be made visible to other devices
- The Bluetooth® SIM Access Profile of the mobile phone must be activated

Authorising and connecting a mobile phone

COMAND Online:

- ▶ Select **Connect device** → **Search for phones** → **SAP phone** → **Start search** → **MB SAP module phones**.

Audio 20:

- ▶ Select **Connect device** → **Connect new device** → **SAP phone**.

Multimedia system:

- ▶ Select the mobile phone.
- ▶ Enter and confirm any 16-digit PIN.
- ▶ Enter and confirm the same PIN on the mobile phone.
- ▶ Where necessary, enter the SIM card PIN into the multimedia system and confirm.

i Please observe the messages in the mobile phone. If necessary, you will be asked to confirm further profile requests.

Switching between mobile phones

If you have authorised more than one mobile phone on the module, you can switch between the individual phones.

- ▶ Select the mobile phone in the device manager.
- ▶ Confirm the connection request; see the manufacturer's operating instructions.
- ▶ Where necessary, enter the SIM card PIN into the multimedia system and confirm.

Data modem mode

- ▶ Connect the mobile phone to the module (▷ page 268).
- or
- ▶ Insert the SIM card into the SIM card slot on the module (▷ page 268).
 - ▶ Before connecting for the first time, enable the module for Internet access and select the mobile phone network provider in the multimedia system (see the Digital Owner's Manual).
Use as a data modem is automatically activated.
 - ▶ Activate/deactivate data roaming (see the Digital Owner's Manual).

For further information on data modem mode without telephony with COMAND Online (see the Digital Owner's Manual).

Settings

Storing/deleting the SIM card PIN

COMAND Online:

- ▶ Select **Connect device** → **MB SAP module phones**.
- ▶ Highlight the mobile phone.
- ▶ To select : navigate to the right.
- ▶ Activate or deactivate **Store PIN**.

Audio 20:

- ▶ Select **Connect device**.
- ▶ Select  in the line of the desired mobile phone.
- ▶ Activate or deactivate **Store PIN**.

Transferring the phone book

In order to use the phone book of the mobile phone via the multimedia system, the phone book must be transferred using the module. The transfer of data may take up to ten minutes. Transmission occurs automatically after a Bluetooth® connection is automatically established.

Text messages

Requirements

The module is connected with the mobile phone (▷ page 268) or is being used in the SIM card mode (▷ page 268).

Activating/deactivating text message downloading from the mobile phone

Dial number	Function
00080	Text message downloading is deactivated.
00081	Text message downloading is activated.

For further information on receiving text messages when using the telephone module (see the Digital Owner's Manual).

Charging a mobile phone

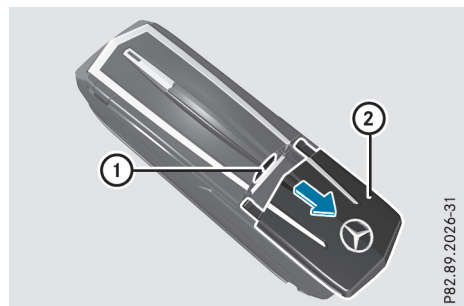

- ▶ Slide cover ② on the module in the direction of the arrow and remove it.
- ▶ Connect the mobile phone via a USB data cable to USB port ①.

Media mode

General notes

If you wish to play external media sources, the appropriate media mode must already be turned on. Further information on media mode; see the Digital Owner's Manual.

The following external media sources can be used:

- Apple® devices (e.g. iPhone®)
- USB devices (e.g. USB stick, MP3 player) (▷ page 270)
- CD
- DVD (COMAND Online)
- SD cards
- via devices connected by Bluetooth®

i Information on the single CD/DVD drive or DVD changer; see the Digital Owner's Manual.

Selecting using the device list

Multimedia system:

- ▶ Select **Media** → **Devices**.
The available media sources will be shown. The ● dot indicates the current setting.
- ▶ Select the media source.
Playable files are played back.

Inserting/removing an SD card

Important safety notes

WARNING

SD cards are small parts. They can be swallowed and cause choking. This poses an increased risk of injury or even fatal injury.

Keep the SD card out of the reach of children. If a SD card is swallowed, seek medical attention immediately.

! If you are no longer using the SD card, you should remove it and store it outside the vehicle. High temperatures can damage the card.

Inserting an SD card

The SD card slot is located on the control panel.

- ▶ Insert the SD card into the SD card slot until the SD card engages. The side with the contacts must face downwards.

Removing an SD card

- ▶ Press the SD card.
The SD card is ejected.
- ▶ Remove the SD card.

Connecting USB devices

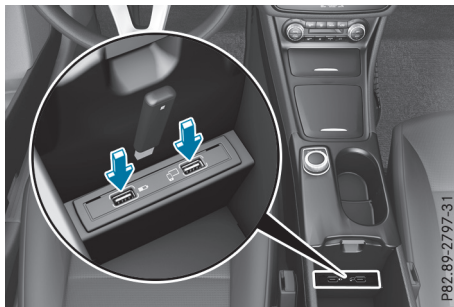

- ▶ Connect the USB device to the USB port.
There are two USB ports in the stowage space under the armrest.
- ▶ Select the media source (▷ page 270).

Loading guidelines

WARNING

If objects, luggage or loads are not secured or not secured sufficiently, they could slip, tip over or be flung around and thereby hit vehicle occupants. There is a risk of injury, especially when braking or abruptly changing directions.

Always store objects so that they cannot be flung around. Secure objects, luggage or loads against slipping or tipping before the journey.

WARNING

Combustion engines emit poisonous exhaust gases such as carbon monoxide. If the tailgate is open when the engine is running, particularly if the vehicle is moving, exhaust fumes could enter the passenger compartment. There is a risk of poisoning.

Turn off the engine before opening the tailgate. Never drive with the tailgate open.

WARNING

The exhaust tail pipe and tail pipe trim can become very hot. If you come into contact with these parts of the vehicle, you could burn yourself. There is a risk of injury.

Always be particularly careful around the exhaust tail pipe and the tail pipe trim. Allow these components to cool down before touching them.

The handling characteristics of a laden vehicle are dependent on the distribution of the load within the vehicle.

Observe the following notes on loading and transporting a load:

- never exceed the maximum permissible gross vehicle weight or the permissible axle loads for the vehicle (including occupants).
- the luggage compartment is the preferred place to store objects.
- position heavy loads as far forwards as possible and as low down in the luggage compartment as possible.

- the load must not protrude above the upper edge of the seat backrests.
- always place the load against the rear or front seat backrests. Make sure that the seat backrests are securely locked into place.
- always place the load behind unoccupied seats if possible.
- use the lashing eyelets and the luggage nets to transport loads and luggage.
- only use lashing eyelets and fastening components that are suitable for the weight and size of the load.
- the maximum load capacity of the stowage well under the luggage compartment floor is 25 kg.
- secure the load with sufficiently strong and wear-resistant lashing material. Pad sharp edges for protection.

! Do not position the load on one part of the folding luggage compartment floor only. The maximum load capacity of the folding luggage compartment floor is 100 kg. Spread the weight evenly to avoid damaging the luggage compartment floor. Place a solid board under the load if necessary. Please note that the load on the luggage compartment floor will be increased when the load is lashed down.

Stowage areas

Stowage compartments

Important safety notes

WARNING

If you transport objects in the vehicle interior and these are not adequately secured, they could slip or be flung around and thereby strike vehicle occupants. In addition, cup holders, open stowage spaces and mobile phone brackets may not always be able to hold the objects placed in them in the event of an accident. There is a risk of injury, particularly in the event of sharp braking or sudden changes of direction.

- Always stow objects in such a way that they cannot be tossed about in these or similar situations.
- Always make sure that objects do not project from stowage spaces, luggage nets or stowage nets.
- Ensure that closable stowage spaces are shut before beginning your journey.
- Always stow and secure heavy, hard, pointed, sharp-edged, fragile or outsize objects in the load compartment.

Observe the loading guidelines (▷ page 271).

Front stowage compartments

Glove compartment

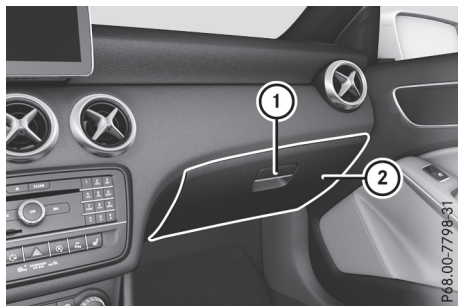

- ▶ **To open:** pull handle ① and open glove compartment flap ②.
- ▶ **To close:** fold glove compartment flap ② upwards until it engages.

There is a pen holder at the top of the glove compartment flap.

Spectacles compartment



- ▶ **To open:** press marking ①.

Make sure that the spectacles compartment is always closed while the vehicle is in motion.

Stowage compartment in the front centre console



Illustration: vehicles with DIRECT SELECT lever

- ▶ **To open:** press the marking on cover ①.
- ⓘ Depending on the vehicle's equipment, there may be an ashtray in the centre console instead of the stowage compartment.

Stowage compartment in front of the armrest (vehicles with automatic transmission)



Vehicles with DIRECT SELECT lever

- ▶ **To open:** press the marking on cover ①.

- ⓘ You can remove the non-slip mat and the insert for cleaning. When removing the insert you will have to overcome some slight resistance.

Stowage compartment/telephone compartment under the armrest



P68.00-7802-31

► **To open:** on vehicles with moveable armrests, make sure that the armrest is in the rearmost position.

► Press button ① and fold the armrest up.

Depending on the vehicle equipment, the armrest can be moved backwards or forwards in a longitudinal direction.

Depending on the vehicle's equipment, the following may be in the stowage space:

- a multimedia connector unit with an SD card slot and 2 USB ports, e.g. for use with an iPod®, iPhone® or MP3 player (see the Digital Owner's Manual)
- a mobile phone bracket (► page 282)

Rear storage compartments

Stowage compartment in the rear centre console



P68.00-7804-31

► **To open:** pull down the top of stowage compartment ① by the edge of the handle.

i Depending on the vehicle's equipment, there may be an open stowage space above the stowage compartment.

Luggage nets

Luggage nets are located:

- in the front-passenger footwell
- on the back of the driver's and front-passenger seat
- on the left and right-hand side in the luggage compartment
- beneath the parcel shelf

Observe the loading guidelines (► page 271) and the safety notes regarding stowage spaces (► page 271).

Through-loading facility in the rear compartment



P68.00-7805-31

► **To open:** fold down seat armrest ①.

► Pull the centre head restraint on the rear bench seat into the uppermost position (► page 100).

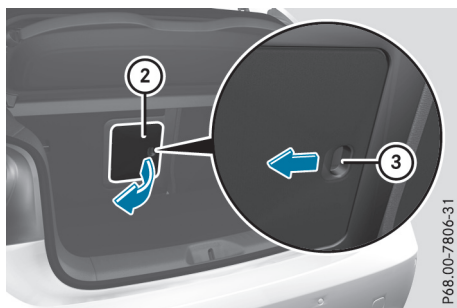

P68.00-7806-31

► Slide locking mechanism ③ in the direction of the arrow.

► Swing flap ② fully to the side.

Flap ② is held open by a magnet.

- ▶ **To close:** swing flap ② in the luggage compartment back until it engages.
 - ▶ Fold armrest ① up fully if necessary.
- Observe the loading guidelines (▷ page 271).

Enlarging the luggage compartment

Important safety notes

WARNING

If the rear bench seat/rear seat and seat backrest are not engaged they could fold forwards, e.g. when braking suddenly or in the event of an accident.

- The vehicle occupant would thereby be pushed into the seat belt by the rear bench seat/rear seat or by the seat backrest. The seat belt cannot protect as intended and could result in additional injury.
- Objects or loads in the boot/luggage compartment cannot be restrained by the seat backrest.

This poses an increased risk of injury.

Before every trip, make sure that the seat backrests and the rear bench seat/rear seat are engaged before every trip.

- !** Before folding the backrest in the rear compartment forwards, make sure that the rear compartment armrest and the cupholder are folded in. They may otherwise be damaged.

Observe the loading guidelines (▷ page 271). The left-hand and right-hand rear seat backrests can be folded forwards separately to increase the luggage compartment capacity.

Folding the rear seat backrest forwards and back

Folding the rear seat backrest forwards

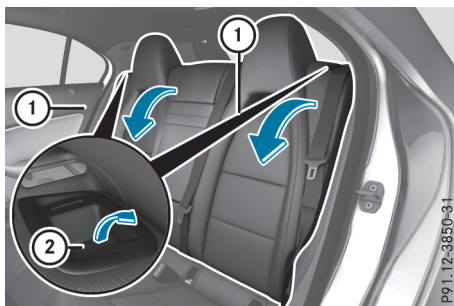

- ▶ Fully insert the backrest head restraints if necessary (▷ page 100).
- ▶ Move the driver's or front-passenger seat forwards if necessary.
- ▶ Pull left-hand or right-hand release handle ② of the seat backrest forwards. The corresponding seat backrest ① is released.
- ▶ Fold backrest ① forwards.
- ▶ Move the driver's or front-passenger seat back if necessary.

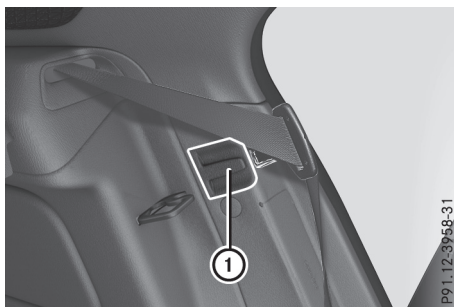

- ▶ Insert the seat belt into seat-belt holder ①.

Folding back the rear seat backrest

- !** Make sure that the seat belt does not become trapped when folding the rear seat backrest back. Otherwise, it could be damaged.

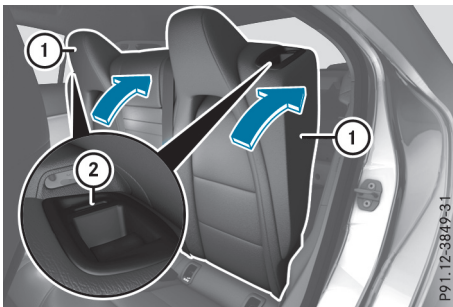

Pg 1.12-3849-31

- ▶ Move the driver's or front-passenger seat forwards if necessary.
- ▶ Fold seat backrest ① back until it engages. Red lock status indicator ② is no longer visible.
- ▶ Adjust the head restraints if necessary (▷ page 100).
- ▶ Move the driver's or front-passenger seat back if necessary.

Securing a load

Lashing eyelets

Observe the following notes on securing loads:

- Observe the loading guidelines (▷ page 271).
- Secure the load using the lashing eyelets.
- Distribute the load on the lashing eyelets evenly.
- Do not use elastic straps or nets to secure a load. These are intended only as anti-slip protection for light loads.
- Do not route lashing materials across sharp edges or corners.
- Pad sharp edges for protection.

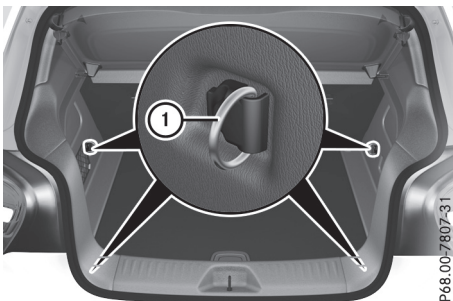

P68.00-7807-31

① Lashing eyelets

Bag hooks

⚠ WARNING

The bag hooks cannot restrain heavy objects or items of luggage. Objects or items of luggage could be flung around and thereby hit vehicle occupants when braking or abruptly changing directions. There is a risk of injury. Only hang light objects on the bag hooks. Never hang hard, sharp-edged or fragile objects on the bag hooks.

- ❗ The bag hook can bear a maximum load of 3 kg. Do not use it to secure a load.

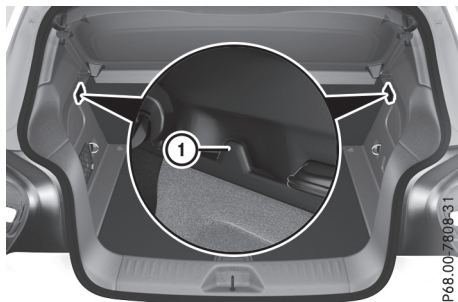

P68.00-7808-31

① Bag hooks

Parcel shelf

- ❗ The maximum load which may be placed on the rear shelf is 2.5 kg.

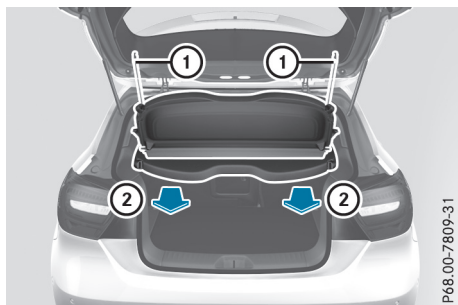

P68.00-7809-31

- ▶ **To remove:** detach straps ① from the tailgate.
- ▶ Fold the parcel shelf downwards.
- ▶ Pull the parcel shelf out to the rear ②.
- ▶ **To fit:** place the parcel shelf on the guide rails on the left and right.

- ▶ Push the parcel shelf evenly forwards using both hands until it engages.
- ▶ Fold the parcel shelf up.
- ▶ Attach straps ① to the tailgate.

Stowage space under the luggage compartment floor

Important safety notes

WARNING

If you drive when the luggage compartment floor is open, objects could be flung around, thus striking vehicle occupants. There is a risk of injury, especially when braking or abruptly changing directions.

Always close the luggage compartment floor before a journey.

- ❗ The maximum load capacity of the stowage well under the luggage compartment floor is 25 kg.

Under the luggage compartment floor you can find a bracket for TIREFIT and the vehicle tool kit, etc.

Opening and closing the luggage compartment floor

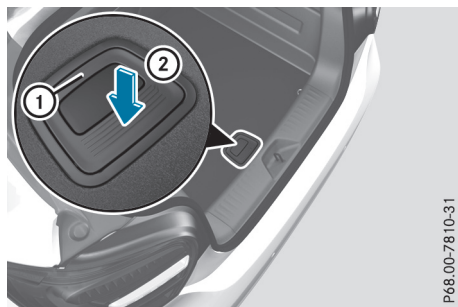

P68.00-7810-31

- ▶ **To open:** open the tailgate.
- ▶ Holding ribbing ②, press handle ① downwards. Handle ① folds upwards.
- ▶ **If a parcel shelf is fitted:** hook the loop on the luggage compartment floor into the hook on the underside of the parcel shelf.

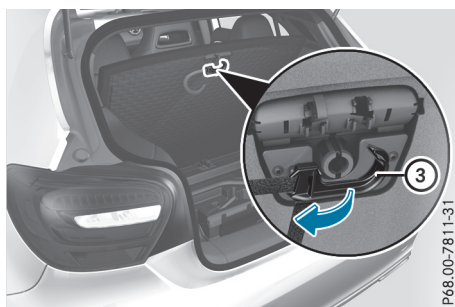

P68.00-7811-31

- ▶ **If the parcel shelf is not fitted:** fold out hook ③ on the underside of the luggage compartment floor.

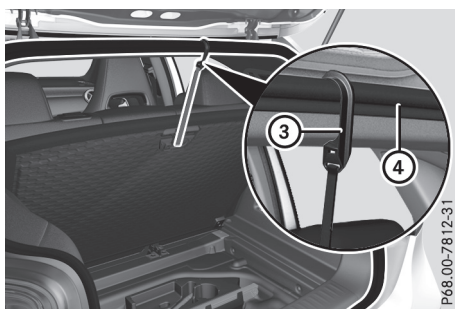

P68.00-7812-31

- ▶ Attach hook ③ to the luggage compartment's upper seal ④.
- ▶ **To close (if a parcel shelf is fitted):** unhook the loop from the hook on the underside of the parcel shelf.
- ▶ **To close (if the parcel shelf is not fitted):** detach hook ③ from upper seal ④.
- ▶ Fasten hook ③ to the bracket on the underside of the luggage compartment floor.
- ▶ Fold the luggage compartment floor down.
- ▶ Press the luggage compartment floor down until it engages.

Roof carrier

Important safety notes

WARNING

When a load is transported on the roof, the vehicle's centre of gravity rises and the handling changes. If you exceed the maximum roof load, the handling as well as steering and

braking characteristics are severely affected. There is a risk of an accident.

Always observe the maximum roof load and adapt your driving style.

! Mercedes-Benz recommends that you only use roof carriers that have been tested and approved for Mercedes-Benz vehicles. This helps to prevent damage to the vehicle.

Position the load on the roof carrier in such a way that the vehicle will not sustain damage even when it is in motion.

Ensure that, depending on the vehicle's equipment, you can raise the panorama sliding sunroof fully and open the tailgate fully when the roof carrier is fitted.

You will find information on the maximum roof load in the "Technical data" section (▷ page 340).

An incorrectly secured roof carrier or roof load may become detached from the vehicle. You must therefore ensure that you observe the roof carrier manufacturer's installation instructions.

i Vehicles with panorama sliding sunroof: if a roof carrier is fitted, the panorama sliding sunroof cannot be opened. In order to allow ventilation of the vehicle interior, you can still raise the panorama sliding sunroof.

If a roof carrier approved by Mercedes-Benz makes contact with the panorama sliding sunroof, the sunroof will lower slightly but remain raised at the rear.

Attaching the roof carrier

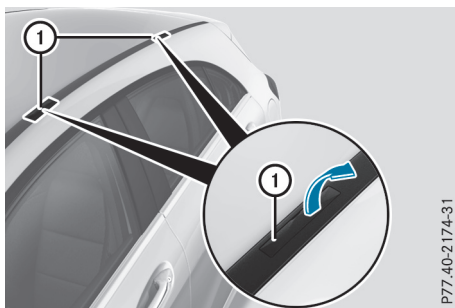

P77.40-2174-31

- ▶ Open and fold the covers ① upwards carefully in the direction of the arrow.
- ▶ Only secure the roof carrier to the anchorage points under covers ①.
- ▶ Observe the manufacturer's installation instructions.

Features

Cup holder

Important safety notes

⚠ WARNING

The cup holder cannot secure a drinks container in place during a journey. If you use a cup holder during a journey, the drinks container could be flung around and liquid could be spilt. Vehicle occupants could come into contact with the liquid and, in particular, be scalded by hot liquid. You could be distracted from the traffic situation and lose control of the vehicle. There is a risk of an accident and injury.

Only use the cup holder when the vehicle is stationary. Only place containers of a suitable size in the cup holder. Seal the container, in particular when it contains hot liquid.

⚠ WARNING

The heating elements of the cup holder can become very hot. You could burn yourself on them.

There is a risk of injury.

Never touch the hot heating elements of the cup holder. Always make sure that the hot heating elements are out of reach of children. Never leave children unattended in the vehicle.

⚠ WARNING

If you transport objects in the vehicle interior and these are not adequately secured, they could slip or be flung around and thereby strike vehicle occupants. In addition, cup holders, open stowage spaces and mobile phone brackets may not always be able to

hold the objects placed in them in the event of an accident. There is a risk of injury, particularly in the event of sharp braking or sudden changes of direction.

- Always stow objects in such a way that they cannot be tossed about in these or similar situations.
- Always make sure that objects do not project from stowage spaces, luggage nets or stowage nets.
- Ensure that closable stowage spaces are shut before beginning your journey.
- Always stow and secure heavy, hard, pointed, sharp-edged, fragile or outsize objects in the load compartment.

! Only use the cup holders for containers of the right size and which have lids. The drinks could otherwise spill.

Observe the loading guidelines (▷ page 271).

The stowage compartments in the doors provide space for bottles:

- front: capacity up to 1.0 l
- rear: capacity up to 0.5 l

Cup holder on the front centre console

Vehicles with automatic transmission



① Cup holder

All vehicles (except vehicles with Audio 5)

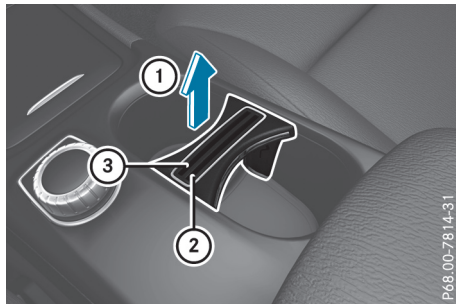

Two coin holders ③ and a card holder ② can be found in the cup holder.

The cup holder and the rubber mat underneath can be removed for cleaning. Clean them with clean, lukewarm water only.

► **To remove:** lift the cup holder up ① and out with a brief tug.

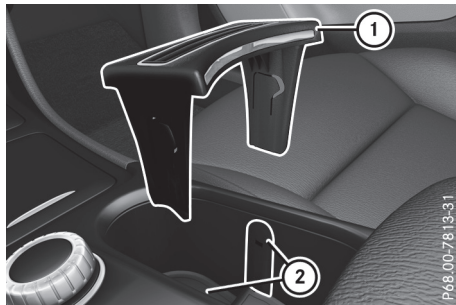

- **To fit:** insert cup holder ① into lateral curved sections ② in the stowage compartment. When doing so, insert the cup holder in such a way that the angle of the upper section of the cup holder faces forwards.
- Press cup holder ① downwards until it engages on the right and left-hand sides.

Vehicles with Audio 5

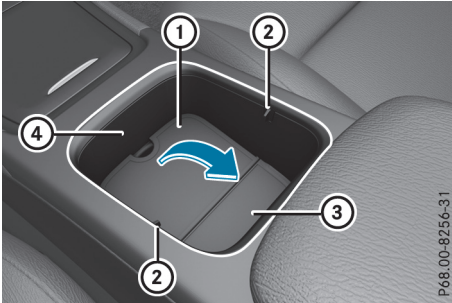

- ▶ Fold lift-up lid ① in stowage compartment ③ up until it engages in the two lugs ②. You can use front part ④ as a cup holder.

Cup holder in the rear seat armrest

- ❗ Do not sit on or support your body weight on the rear seat armrest when it is folded down, as you could otherwise damage it.
- ❗ Close the cup holder before folding the rear seat armrest up. Otherwise, the cup holder could be damaged.



- ▶ Fold down the rear seat armrest.
- ▶ **To open:** press the front of cup holder ① or ②. Cup holder ① or ② extends automatically.
- ▶ **To close:** slide cup holder ① or ② back until it engages.

Sun visors

Overview

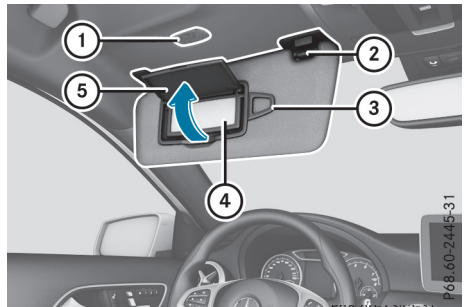

- ① Mirror light
- ② Retainer
- ③ Retaining clip, e.g. for a car park ticket
- ④ Vanity mirror
- ⑤ Mirror cover

Vanity mirror in the sun visor

Mirror light ① only functions if the sun visor is clipped into retainer ② and mirror cover ⑤ has been folded up.

Glare from the side

- ▶ Fold down the sun visor.
- ▶ Pull the sun visor out of retainer ②.
- ▶ Swing the sun visor to the side.

Ashtray

Front ashtray

- ❗ The stowage space under the ashtray is not heat resistant. Before placing lit cigarettes in the ashtray, make sure that the ashtray is properly engaged. Otherwise, the stowage space could be damaged.

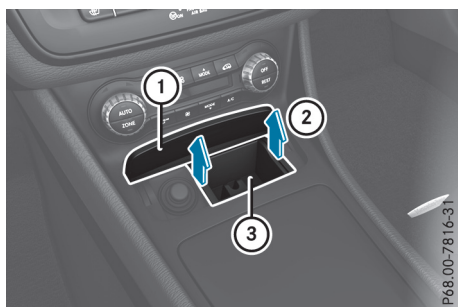

- ▶ **Vehicles with a stowage compartment cover:** press the lower section of cover ①. The stowage compartment opens.
- ▶ **To remove the insert:** lift insert ③ up ② and out.
- ▶ **To refit the insert:** press insert ③ into the holder until it engages.

i If you remove the ashtray insert, you can use the resulting compartment for stowage.

Rear-compartment ashtray

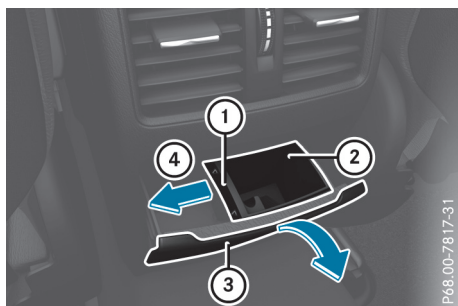

- ▶ **To open:** pull cover ③ out by its top edge.
- ▶ **To remove:** pull insert ② by recess ① in the direction of arrow ④ until it audibly releases.
- ▶ Lift insert ② up and out.
- ▶ **To fit the insert:** fit insert ② from above into the holder and press down until it engages.

Cigarette lighter

WARNING

You can burn yourself if you touch the hot heating element or the socket of the cigarette lighter.

In addition, flammable materials can ignite if:

- the hot cigarette lighter falls
- a child holds the hot cigarette lighter to objects, for example

There is a risk of fire and injury.

Always hold the cigarette lighter by the knob. Always make sure that the cigarette lighter is out of reach of children. Never leave children unattended in the vehicle.

Your attention must always be focused on the traffic conditions. Use the cigarette lighter only when road and traffic conditions permit.

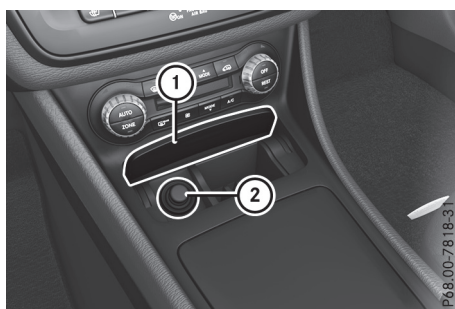

- ▶ Turn the key to position ② in the ignition lock (▷ page 135).
- ▶ **Vehicles with a stowage compartment cover:** press the lower section of cover ①. The stowage compartment opens.
- ▶ Press in cigarette lighter ②. Cigarette lighter ② will pop out automatically when the heating element is red-hot.

12 V sockets

General notes

- ▶ Turn the key to position ① in the ignition lock (▷ page 135).

The sockets can be used for accessories with a maximum draw of 180 W (15 A). Accessories include such items as mobile phone chargers. If you use the sockets for long periods when the engine is switched off, the battery may discharge.

An emergency cut-off ensures that the on-board voltage does not drop too low. If the on-board voltage is too low, the power to the sockets is

automatically cut. This ensures that there is sufficient power to start the engine.

Socket on the front centre console

- ▶ **Vehicles with a stowage compartment cover:** press the lower section of the cover. The stowage compartment opens.
- ▶ Lift up the cover of the socket.

Socket on the rear-compartment centre console

- ▶ Pull the cover out by the top of its handle edge.
- ▶ Lift up the cover of the socket.

Socket in the luggage compartment

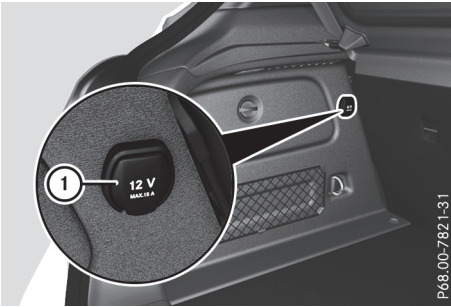

- ▶ Lift up the cover of socket ①.

P68.00-7821-31

Mercedes-Benz emergency call system

Information on these requirements can be found in the Digital Owner's Manual.

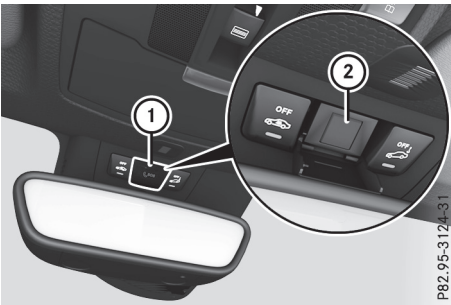

P82.95-3124-31

- ▶ **To open:** press cover ① briefly.
- ▶ **To make an emergency call:** press SOS button ② briefly. The indicator lamp on SOS button ② flashes until the emergency call is concluded.
- ▶ Wait for a voice connection to the Mercedes-Benz emergency call centre.
- ▶ After the emergency call, close cover ①. You will see a message if:
 - a connection to the Mercedes-Benz emergency call centre cannot be established
 - a call has not been automatically forwarded to the public emergency call centre
 In this case, dial the **112** emergency number on your mobile phone.

You can find more information on the Mercedes-Benz emergency call system in the Digital Owner's Manual.

Mobile phone

Important safety notes

⚠ WARNING

If you operate mobile communication equipment while driving, you can be distracted from the traffic situation. This could also cause you to lose control of the vehicle. There is a risk of an accident.

Only operate this equipment when the vehicle is stationary.

You must observe the legal requirements for the country in which you are currently driving when operating mobile communications equipment in the vehicle.

If it is permitted by law to operate communications equipment while the vehicle is in motion, you may do so only if the traffic situation permits. You may otherwise be distracted from the traffic conditions, cause an accident and injure yourself and others.

Excessive levels of electromagnetic radiation may cause damage to your health and to the health of others. The use of an exterior aerial takes into consideration the scientific discussion surrounding the possible health risk posed by electromagnetic fields.

Mercedes-Benz recommends the use of an approved exterior aerial. This ensures:

- optimal mobile phone reception quality in the vehicle
- that mutual interference between the vehicle electronics and mobile phones is minimised

An exterior aerial has the following advantages:

- it conducts the electromagnetic fields generated by a wireless device to the exterior
- the field strength in the vehicle interior is lower than in a vehicle that does not have an exterior aerial

Information on retrofitting two-way radios and mobile phones (RF transmitters) (▷ page 332).

General notes

There are various mobile phone brackets that may be fitted in your vehicle; in some cases, these are country-specific.

You can connect a Bluetooth®-capable mobile phone with the multimedia system via the Bluetooth® interface. This also applies if your vehicle is equipped with convenience telephony.

More information on suitable mobile phones, mobile phone brackets and on connecting Bluetooth®-capable mobile phones with the multimedia system can be obtained:

- at your Mercedes-Benz Service Centre
- on the Internet at <http://www.mercedes-benz.com/connect>

The functions and services available when you use the phone depend on your mobile phone model and service provider.

Using a mobile phone

To connect a mobile phone to the exterior aerial and charge it, insert it into the mobile phone bracket.

- ▶ Open the telephone compartment (▷ page 273).
- ▶ Place the mobile phone bracket into the pre-installed fitting; see the separate installation instructions for the mobile phone fitting.
- ▶ Insert the mobile phone into the mobile phone bracket; see the separate installation instructions for the mobile phone fitting.



i The mobile phone can also be operated without being in the bracket. However, the

charging function and aerial function are not available.

In order to use Bluetooth® (SAP profile) on your telephone module, you must first insert the telephone module into the pre-installed fitting. This connects it to the exterior aerial. If you wish to charge the mobile phone, you must connect it to a USB port.

Further information on the telephone module with Bluetooth® (SAP profile) can be found in the Digital Owner's Manual.

Operating the mobile phone

You can operate the phone using the  and  buttons on the multifunction steering wheel. You can operate other mobile phone functions via the on-board computer (▷ page 208).

When you remove the key from the ignition lock, the mobile phone is disconnected from the vehicle. You can then no longer make calls using the hands-free system.

If a call is active and you remove the key from the ignition lock, the conversation is transferred over to the mobile phone. It is then possible to continue the conversation on the mobile phone.

Mobile phone bracket in the stowage compartment



You can fold the pre-installed bracket up to improve access to the stowage space beneath it.

Further information about the stowage compartment (▷ page 273).

- ▶ **To fold the bracket up:** press button ①.
- ▶ **To fold the bracket down:** press the bracket down and allow it to engage.

Floormats

WARNING

Objects in the driver's footwell may restrict the clearance around the pedals or block a depressed pedal. This jeopardises the operating and road safety of the vehicle. There is a risk of an accident.

Stow all objects securely in the vehicle so that they do not get into the driver's footwell.

Always fit the floormats securely and as prescribed in order to ensure that there is always sufficient room for the pedals. Do not use loose floormats and do not place several floormats on top of one another.

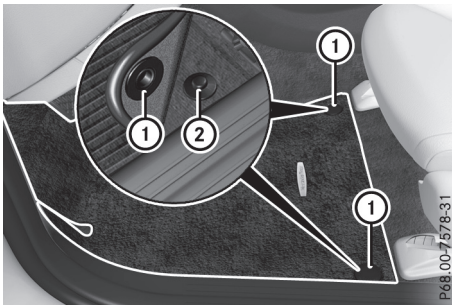

- ▶ Slide the seat backwards.
- ▶ **To fit:** lay the floormat in the footwell.
- ▶ Press safety catch knobs ① onto retainers ②.
- ▶ **To remove:** pull the floormat away from retainers ②.
- ▶ Remove the floormat.

Retrofitted anti-glare film

Retrofitted anti-glare film on the inside of the windows can interfere with radio/mobile telephone reception. This is particularly the case for conductive or metallic-coated films. You can obtain information about anti-glare film from a qualified specialist workshop.

Engine compartment

Bonnet

Important safety notes

WARNING

An unlocked bonnet may open up when the vehicle is in motion and block your view. There is a risk of an accident.

Never unlock the bonnet when driving. Before every trip, ensure that the bonnet is locked.

WARNING

When being opened and closed, the bonnet may suddenly fall into the closed position. There is a risk of injury to persons in the range of movement of the bonnet.

Open and close the bonnet only when nobody is in the range of movement.

WARNING

If you open the bonnet while the engine is overheating or while there is a fire in the engine compartment, you could come into contact with hot gases or other leaking service products. There is a danger of injury.

Allow an overheating engine to cool down before opening the bonnet. If there is a fire in the engine compartment, leave the bonnet closed and notify the fire brigade.

WARNING

There are moving components in the engine compartment. Certain components may continue to move or suddenly move again even after the ignition has been switched off, e.g. the radiator fan. There is a risk of injury.

If you have to carry out work in the engine compartment:

- switch off the ignition
- never touch the dangerous areas surrounding moving components, e.g. the rotation area of the fan

- remove jewellery and watches
- keep items of clothing and hair, for example, away from moving parts.

WARNING

The ignition system and the fuel injection system operate with a high voltage. If you touch the live components, you could receive an electric shock. There is a danger of injury.

Never touch components of the ignition system or the fuel injection system when the ignition is switched on.

Active bonnet (pedestrian protection)

Operating principle

 A triggered active bonnet must be repaired at a qualified specialist workshop. The active bonnet function will then be available again. The additional pedestrian protection provided by the active bonnet will then be restored.

The active bonnet is available only for certain countries.

The active bonnet can reduce the risk of injury to pedestrians in certain accident situations. Raising the active bonnet increases the clearance to hard components, such as the engine.

If the active bonnet has been triggered, it is raised at the rear in the area around the hinge by approximately 60 mm.

For the drive to the workshop, reset the triggered active bonnet yourself. If the active bonnet has been triggered, pedestrian protection may be limited.

Resetting

WARNING

Certain components in the engine compartment could be very hot, e.g. the engine, the radiator and parts of the exhaust system.

There is a risk of injury when accessing the engine compartment.

As far as possible, allow the engine to cool down and only touch the components described in the following.

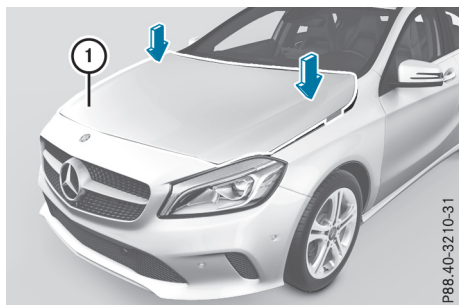

P88.40-32.10-31

- ▶ With your hand flat, push down active bonnet ① in the area around the hinges on both sides (arrows) until you feel it engage.

If you can raise the active bonnet slightly at the rear in the area around the hinges, it is not engaged correctly. Repeat the step.

If the bonnet can then still be raised, drive directly to a qualified specialist workshop. Do not drive faster than 100 km/h.

Opening the bonnet

WARNING

Certain components in the engine compartment could be very hot, e.g. the engine, the radiator and parts of the exhaust system. There is a risk of injury when accessing the engine compartment.

As far as possible, allow the engine to cool down and only touch the components described in the following.

WARNING

When the bonnet is open, and the windscreen wipers are set in motion, you can be injured by the wiper linkage. There is a risk of injury.

Always switch off the windscreen wipers and the ignition before opening the bonnet.

- ▶ **!** Make sure that the windscreen wipers are not folded away from the windscreen. Otherwise, you could damage the windscreen wipers or the bonnet.



P88.40-32.11-31

- ▶ Make sure that the windscreen wipers are switched off.
- ▶ Pull release lever ① on the bonnet. The bonnet is released.

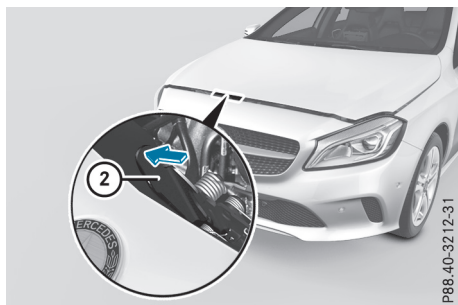

P88.40-32.12-31

- ▶ Reach into the gap between the bonnet and the radiator trim and press bonnet catch lever ② to the left.
- ▶ Raise the bonnet.

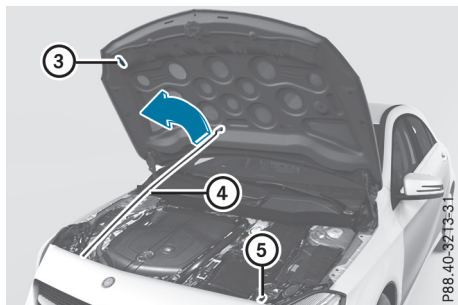

P88.40-32.13-31

- ▶ Pull support strut ④ out of bracket ⑤.
- ▶ Lift up support strut ④ and insert it into yellow retaining clip ③.

Closing the bonnet

- ▶ Raise the bonnet slightly and, at the same time, remove support strut ④ from yellow retaining clip ③.
- ▶ Swing support strut ④ down and press it into bracket ⑤ until it engages.
- ▶ Lower the bonnet and let it fall from a height of approximately 20 cm.
- ▶ Check that the bonnet has engaged properly. If the bonnet can be raised slightly, it is not properly engaged. Do not press the bonnet closed. Open the bonnet again and close it with a little more force.

Engine oil

General notes

Depending on your driving style, the vehicle consumes up to 0.8 litres of oil per 1,000 km. The oil consumption may be higher than this when the vehicle is new or if you frequently drive at high engine speeds.

Depending on the engine, the oil dipstick may be installed at different locations.

To check the oil level:

- park the vehicle on a level surface
- the engine should be switched off for approximately five minutes if the engine is at normal operating temperature
- if the engine is not at normal operating temperature, e.g. if the engine was only started briefly, wait approximately 30 minutes before carrying out the measurement

Checking the oil level using the dipstick

⚠ WARNING

Certain components in the engine compartment could be very hot, e.g. the engine, the radiator and parts of the exhaust system. There is a risk of injury when accessing the engine compartment.

As far as possible, allow the engine to cool down and only touch the components described in the following.

⚠ WARNING

Safety relevant functions are restricted or no longer available if:

- the engine is not running
- the brake system or power steering is malfunctioning
- there is a malfunction in the voltage supply or the vehicle's electrical system

When your vehicle is towed away or towed started, you may require considerably more effort to steer and brake. There is a risk of an accident.

In such cases use a rigid towing bar. Before being towed away or tow started, make sure the steering moves freely.

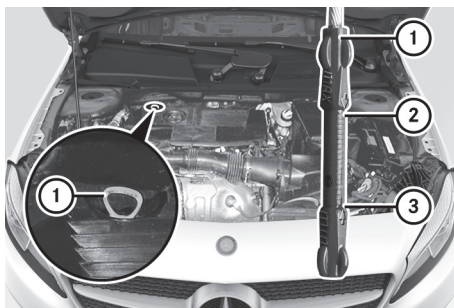

Example: vehicles with a petrol engine

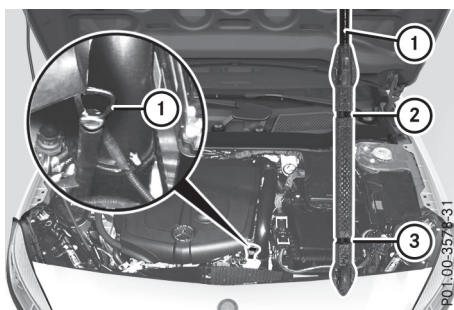

Vehicles with a diesel motor, except the A 160 d and A 180 d models

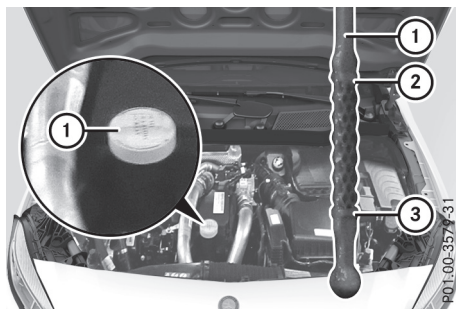

A 160 d and A 180 d models

- ▶ **All models except A 160 d and A 180 d:** pull out oil dipstick ①.
- ▶ **Models A 160 d and A 180 d:** pull out the oil dipstick ①.
- ▶ Wipe off oil dipstick ①.
- ▶ Slowly slide oil dipstick ① into the guide tube as far as it will go, and take it out again. If the level is between MIN mark ③ and MAX mark ②, the oil level is correct.
- ▶ If the oil level has dropped to MIN mark ③ or below, top up with 1.0 l of engine oil.

Topping up engine oil

WARNING

Certain components in the engine compartment could be very hot, e.g. the engine, the radiator and parts of the exhaust system. There is a risk of injury when accessing the engine compartment.

As far as possible, allow the engine to cool down and only touch the components described in the following.

WARNING

If engine oil comes into contact with hot components in the engine compartment, it may ignite. There is a risk of fire and injury.

Make sure that engine oil does not spill out over the filler neck. Allow the engine to cool down and thoroughly clean the components that have come into contact with engine oil before you start the engine.

Environmental note

When topping up the oil, take care not to spill any. If oil enters the soil or waterways, it is harmful to the environment.

- ! Use only engine oils and oil filters that are approved for vehicles with a service system. A list of the engine oils and oil filters that have been tested and approved in accordance with Mercedes-Benz Specifications for Service Products is available at any Mercedes-Benz Service Centre.

The following cause engine failure or damage to the exhaust system:

- Use of engine oils and oil filters that have not been expressly approved for the service system
- Replacement of engine oil and oil filter after the replacement interval specified by the service system has expired
- Use of engine oil additives

- ! Do not add too much oil. Topping up with too much engine oil can result in damage to the engine or to the catalytic converter. Have excess engine oil siphoned off.

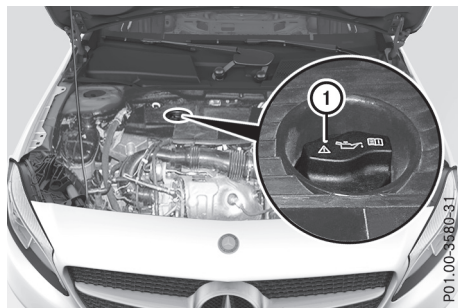

Example: engine oil filler cap

- ▶ Turn cap ① anti-clockwise and remove it.
- ▶ Top up the engine oil.
If the oil level is at or below the MIN mark on the oil dipstick, top up with 1.0 l of engine oil.
- ▶ Replace cap ① on the filler neck and turn clockwise.
Make sure that the cap locks securely into place.
- ▶ Check the oil level again with the oil dipstick (> page 286).

Further information on engine oil (> page 337).

Checking and adding other service products

Checking the coolant level

WARNING

The cooling system is pressurised, particularly when the engine is warm. If you open the cap, you could be scalded if hot coolant sprays out. There is a risk of injury.

Let the engine cool down before you open the cap. Wear gloves and eye protection. Open the cap slowly to release the pressure.

- !** The coolant level must only be checked and corrected when the engine has cooled down (coolant temperature under 40 °C). Checking the coolant level when the coolant temperature is over 40 °C can lead to damage to the engine or engine cooling system.

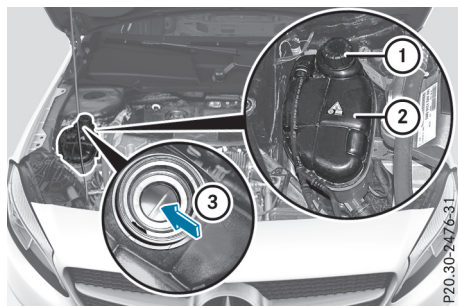

- ▶ Park the vehicle on a level surface. Check the coolant level only if the vehicle is on a level surface and the engine has cooled down.
- ▶ Turn the key to position **2** in the ignition lock (> page 135).
- ▶ Check the coolant temperature display in the instrument cluster. The coolant temperature must be below 40 °C.
- ▶ Turn the key to position **0** in the ignition lock (> page 135).
- ▶ Slowly turn cap **1** anti-clockwise and to relieve excess pressure.
- ▶ Turn cap **1** further anti-clockwise and remove it. If the coolant is at the level of marker bar **3** in the filler neck when cold, there is enough coolant in coolant expansion tank **2**.

- ▶ If necessary, top up with coolant that has been tested and approved by Mercedes-Benz.
- ▶ Replace cap **1** and turn it clockwise as far as it will go.

Further information on coolant (> page 339).

Windscreen washer system

WARNING

Certain components in the engine compartment could be very hot, e.g. the engine, the radiator and parts of the exhaust system. There is a risk of injury when accessing the engine compartment.

As far as possible, allow the engine to cool down and only touch the components described in the following.

WARNING

If windscreen washer concentrate comes into contact with hot components of the engine or the exhaust system, it can ignite. There is a risk of fire and injury.

Make sure the windscreen washer concentrate does not come into contact with the filler neck.

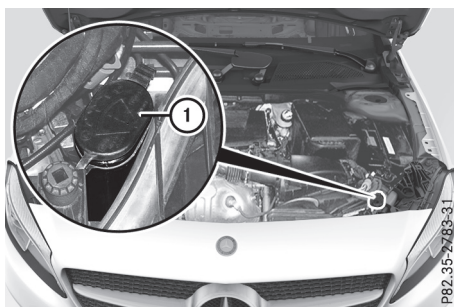

- ▶ **To open:** pull cap **1** upwards by the tab.
- ▶ Top up with the premixed washer fluid.
- ▶ **To close:** press cap **1** onto the filler neck until it engages.

If the washer fluid level drops below the recommended minimum of 1 litre, a message appears in the multifunction display prompting you to top up the washer fluid (> page 247).

Further information on windscreen washer fluid/antifreeze (> page 339).

ASSYST PLUS

Service message

The ASSYST PLUS service interval display informs you of the next service due date.

You can find information on the type of service and service intervals in the Service Booklet.

You can obtain further information from a Mercedes-Benz Service Centre.

- i** The ASSYST PLUS service interval display does not show any information on the engine oil level. Observe the notes on the engine oil level (▷ page 286).

The multifunction display shows a service message for a few seconds, e.g.:

- Service A in .. days
- Service A due
- Service A overdue by .. days

Depending on the operating conditions of the vehicle, the remaining time or distance until the next service due date is displayed.

The letter indicates which service is due. **A** stands for a minor service and **B** for a major service. A number or another letter may be displayed after the letter.

For certain countries only: the position after the letter **A** or **B** indicates any necessary additional maintenance work. If you notify a qualified specialist workshop of this display, you will receive a statement on the associated costs.

The ASSYST PLUS service interval display does not take into account any periods of time during which the battery is disconnected.

Maintaining the time-dependent service schedule:

- ▶ Note down the service due date displayed in the multifunction display before disconnecting the battery.

or

- ▶ After reconnecting the battery, subtract the battery disconnection periods from the service date shown on the display.

Hiding service messages

- ▶ Press the **OK** or **↩** button on the steering wheel.

Displaying service messages

- ▶ Switch the ignition on.
- ▶ Press the **◀** or **▶** button to select the **Serv.** menu.
- ▶ Press the **▲** or **▼** button to select the **ASSYST PLUS** submenu and confirm by pressing the **OK** button.
The service due date appears in the multifunction display.

Information about service

Resetting the ASSYST PLUS service interval display

- !** If the ASSYST PLUS service interval display has been inadvertently reset, this setting can be corrected at a qualified specialist workshop.

Have service work carried out as described in the Service Booklet. This may otherwise lead to increased wear and damage to the major assemblies or the vehicle.

A qualified specialist workshop, e.g. a Mercedes-Benz Service Centre, will reset the ASSYST PLUS service interval display after the service work has been carried out. You can also obtain further information on maintenance work, for example.

Special service requirements

The prescribed service interval is based on normal operation of the vehicle. Service work will need to be performed more often if the vehicle is operated under arduous conditions or increased loads, for example:

- Regular city driving with frequent intermediate stops
- If the vehicle is primarily used to travel short distances
- For frequent use in mountainous terrain or on poor road surfaces
- If the engine is often left idling for long periods
- In particularly dusty conditions, or if air-recirculation mode is frequently used.

In these or similar operating conditions, have the interior filter, engine air cleaner, engine oil and oil filter, for example, changed more frequently. The tyres must be checked more fre-

quently if the vehicle is operated under increased loads. Further information can be obtained at a qualified specialist workshop, e.g. a Mercedes-Benz Service Centre.

Driving abroad

An extensive Mercedes-Benz Service network is also available in other countries. You can obtain further information from any Mercedes-Benz Service Centre.

Care

General notes

Environmental note

Dispose of empty packaging and cleaning cloths in an environmentally responsible manner.

! When cleaning your car, do not use:

- dry, coarse or hard cloths
- abrasive cleaning agents
- solvents
- cleaning agents containing solvents

Do not scrub.

Do not touch the surfaces and films with hard objects, e.g. rings or ice scrapers. Otherwise, you may scratch or damage the surfaces and films.

! Do not park up your vehicle for a long period of time immediately after cleaning, particularly after cleaning the wheel rim with wheel cleaner. Wheel cleaner may lead to increased corrosion of the brake discs and pads. You should therefore drive for a few minutes after cleaning. By heating up the brakes, the brake discs and pads dry. The vehicle can then be parked up for a long period of time.

Regular care of your vehicle is a condition for retaining quality in the long term.

Use care products and cleaning agents recommended and approved by Mercedes-Benz.

Washing the vehicle and cleaning the paintwork

Automatic car wash

WARNING

Braking efficiency is reduced after the vehicle has been washed. There is a risk of an accident.

After washing the vehicle, brake carefully while paying attention to the traffic conditions in order to restore full braking efficiency.

! When Distance Pilot DISTRONIC or the HOLD function is activated, the vehicle brakes automatically in certain situations. To avoid damage to the vehicle, deactivate Distance Pilot DISTRONIC and the HOLD function in the following or similar situations:

- when towing away
- in a car wash

! Make sure that the automatic transmission is in transmission position **[N]** when washing your vehicle in a tow-through car wash. The vehicle may be damaged in another transmission position.

! Make sure:

- the side windows and sliding sunroof are closed completely
- the blower is switched off
- the windscreen wiper switch is at position **[0]**

The vehicle could otherwise be damaged.

You can clean the vehicle in an automatic car wash from the very start.

Preferably, you should wash the vehicle in a car wash that uses fabric washing elements without brushes. This will prevent fine scratches to the paintwork or decorative films.

If the vehicle is very dirty, wash off excess dirt before cleaning the vehicle in an automatic car wash.

After using an automatic car wash, wipe off the wax from the windscreen and the windscreen wiper blades. This will prevent smears and reduce wiping noises caused by residue on the windscreen.

- i** Vehicles with decorative films: when using a car wash, choose a wash program without hot wax.

Washing by hand

In some countries, washing by hand is only allowed at specially equipped washing bays. Observe the legal requirements for each individual country.

- ▶ Do not use hot water and do not wash the vehicle in direct sunlight.
- ▶ Use a soft sponge to clean the vehicle.
- ▶ Use a mild cleaning agent, such as a car shampoo approved by Mercedes-Benz.
- ▶ Thoroughly hose down the vehicle with a gentle jet of water.
- ▶ Do not point the water jet directly towards the air inlet or the edges of decorative foils.
- ▶ Use plenty of water and rinse the sponge frequently.
- ▶ Rinse the vehicle with clean water and dry thoroughly with a chamois.
- ▶ Do not let the cleaning agent dry on the paintwork or the decorative foils.

When using the vehicle in winter, remove all traces of road salt deposits carefully and as soon as possible.

High-pressure cleaner

WARNING

The water jet of circular-jet nozzles (dirt grinders) can cause damage not visible from the outside to tyres or chassis components. Components damaged in this way can unexpectedly fail. There is a risk of an accident.

Do not use high-pressure cleaners with circular-jet nozzles to clean the vehicle. Have damaged tyres or chassis components replaced immediately.

- !** Vehicles with decorative foil: parts of your vehicle are covered with decorative foil. Maintain a distance of at least 70 cm between the foil-wrapped parts of the vehicle and the nozzle of the high pressure cleaner.
Information about the correct distance is available from the equipment manufacturer.

Move the high-pressure cleaner nozzle around whilst cleaning.

The water temperature of the high-pressure cleaner must not exceed 60 °C.

- !** Always maintain a distance of at least 30 cm between the vehicle and the high-pressure cleaner nozzle. Information about the correct distance is available from the equipment manufacturer.

Move the high-pressure cleaner nozzle around whilst cleaning.

Do not aim directly at any of the following:

- tyres
- door gaps, roof gaps, joints etc.
- electrical components
- battery
- plug-type couplings
- lights
- seals
- trim elements
- ventilation slots

Damage to seals or electrical components can lead to leaks or failures.

Cleaning the paintwork

- !** Do not affix:

- stickers
- films
- magnetic plates or similar items

to painted surfaces. You could otherwise damage the paintwork.

Scratches, corrosive deposits, areas affected by corrosion and damage caused by inadequate care cannot always be completely repaired. In such cases, visit a qualified specialist workshop.

- ▶ Remove impurities immediately, where possible, whilst avoiding rubbing too hard.
- ▶ Soak insect remains with insect remover and rinse off the treated areas afterwards.
- ▶ Soak bird droppings with water and rinse off the treated areas afterwards.
- ▶ Remove coolant, brake fluid, tree resins, oils, fuels and greases by rubbing gently with a cloth soaked in petroleum ether or lighter fluid.
- ▶ Use tar remover to remove tar stains.
- ▶ Use silicone remover to remove wax.

Care and treatment of matt paintwork

! Never polish the vehicle or the light alloy wheels. Polishing makes the paintwork shiny.

! The following can give the paint a glossy appearance and thus reduce the matt effect:

- Rubbing hard with unsuitable agents
- Washing the vehicle in direct sunlight

! Never use paint cleaner, buffing or polishing products, or gloss preserver, e.g. wax, for the purpose of paintwork care. These products are only suitable for high-gloss surfaces. Their use on vehicles with matt paintwork leads to considerable surface damage or, more specifically, to shiny, spotted areas.

Always have paintwork repairs carried out at a qualified specialist workshop.

! Only use automatic car washes which correspond to the latest technological standards. Never use wash programs which finish by treating the vehicle with hot wax.

Observe these notes if your vehicle has a clear matt finish. This will help you to avoid damage to the paintwork due to incorrect treatment.

These notes also apply to light-alloy wheels with a clear matt finish.

Use only insect remover and car shampoo from the range of approved Mercedes-Benz care products.

Cleaning the decorative film

! The following may have an effect on the service life and colouring of decorative film:

- sunlight
- temperature, e.g. hot-air fan
- weather conditions
- stone impacts and dirt
- chemical cleaning agents
- greasy substances

! Do not use any types of polish on matt decorative film. Polishing surfaces covered with film gives it a shiny finish.

! Do not treat matt or structured decorative film with wax. This may lead to marks that cannot be removed.

Observe the notes in the section on the care and treatment of matt paintwork (> page 292); these notes also apply to matt decorative film.

To clean, use plenty of water and a mild cleaning agent without additional or abrasive products, e.g. a car shampoo approved by Mercedes-Benz.

▶ Dry vehicles covered with film using a soft, absorbent cloth after every wash. Water marks could otherwise form.

Scratches, corrosive deposits, areas affected by corrosion and damage caused by inadequate care cannot always be completely repaired. In such cases, visit a qualified specialist workshop.

- ▶ Remove impurities immediately, where possible, whilst avoiding rubbing too hard. The decorative film may be irreparably damaged.
- ▶ Soak insect remains with insect remover and rinse off the treated areas afterwards.
- ▶ Soak bird droppings with water and rinse off the treated areas afterwards.

The cleaning product Paint Cleaner, which has been approved and recommended by Mercedes-Benz, should be used when dirt has penetrated the decorative film surface or the decorative film has become dull.

The manufacturer can provide you with information on special care and cleaning products. Surfaces covered with a decorative film may, once a decorative film has been removed, feature visual differences from the surfaces that were not protected by a decorative film.

i Have work or repairs on decorative film carried out at a qualified specialist workshop. Mercedes-Benz recommends that you use a Mercedes-Benz Service Centre for this purpose.

Cleaning vehicle parts

Cleaning the wheels

WARNING

The water jet of circular-jet nozzles (dirt grinders) can cause damage not visible from the outside to tyres or chassis components. Components damaged in this way can unexpectedly fail. There is a risk of an accident.

Do not use high-pressure cleaners with circular-jet nozzles to clean the vehicle. Have dam-

aged tyres or chassis components replaced immediately.

- ❗ Do not use acidic wheel cleaning products to remove brake dust. This could damage wheel bolts and brake components.
- ❗ Do not park up your vehicle for a long period of time immediately after cleaning, particularly after cleaning the wheel rim with wheel cleaner. Wheel cleaner may lead to increased corrosion of the brake discs and pads. You should therefore drive for a few minutes after cleaning. By heating up the brakes, the brake discs and pads dry. The vehicle can then be parked up for a long period of time.

Cleaning the windows

WARNING

If the windscreen wipers are set in motion when cleaning the windscreen or wiper blades, you could become trapped. There is a danger of injury.

Always switch off the windscreen wipers and the ignition before cleaning the windscreen or wiper blades.

- ❗ Only fold the windscreen wipers away from the windscreen when vertical. Otherwise, you will damage the bonnet.
- ❗ Do not use dry cloths, abrasive cleaning agents, solvents or solvent-based cleaning agents to clean the inside of the windows/windscreen. Do not touch the inside of the windows/windscreen with hard items such as an ice scraper or a ring. Otherwise, the windows/windscreen could be damaged.
- ❗ Clean the water drainage channels of the windscreen and the rear window at regular intervals. Deposits such as leaves, petals and pollen may under certain circumstances prevent water from draining away. This can lead to corrosion damage and damage to electronic components.
- ▶ Clean the inside and outside of the windows with a damp cloth and a cleaning agent that is recommended and approved by Mercedes-Benz.

Cleaning the wiper blades

WARNING

If the windscreen wipers are set in motion when cleaning the windscreen or wiper blades, you could become trapped. There is a danger of injury.

Always switch off the windscreen wipers and the ignition before cleaning the windscreen or wiper blades.

- ❗ Only fold the windscreen wipers away from the windscreen when vertical. Otherwise, you will damage the bonnet.
- ❗ Do not pull on the wiper blade. Otherwise, the wiper blade could be damaged.
- ❗ Do not clean wiper blades too often and do not rub them too hard. Otherwise, the graphite coating could be damaged. This could cause wiper noise.
- ❗ Hold the wiper arm securely when folding back. The windscreen could be damaged if the wiper arm hits against it suddenly.
- ▶ Fold the wiper arms away from the windscreen.
- ▶ Clean the wiper blades carefully using a damp cloth.
- ▶ Fold the windscreen wipers back again before switching on the ignition.

Cleaning the exterior lighting

- ❗ Only use cleaning agents or cleaning cloths that are suitable for plastic lenses. Unsuitable cleaning agents or cleaning cloths could scratch or damage the plastic lenses of the exterior lighting.
- ▶ Clean the plastic lenses of the exterior lighting using a wet sponge and a mild cleaning agent, e.g. Mercedes-Benz car shampoo or cleaning cloths.

Cleaning the mirror turn signal

- ❗ Only use cleaning agents or cleaning cloths that are suitable for plastic lenses. Unsuitable cleaning agents or cleaning cloths could scratch or damage the plastic lenses of the mirror turn signals.

- ▶ Clean the plastic lenses of the mirror turn signals in the exterior mirror housing using a wet sponge and mild cleaning agent, e.g. Mercedes-Benz car shampoo or cleaning cloths.

Cleaning the sensors

- ❗ If you clean the sensors with a high-pressure cleaner, make sure that you keep a distance of at least 30 cm between the vehicle and the high-pressure cleaner nozzle. Information about the correct distance is available from the equipment manufacturer.

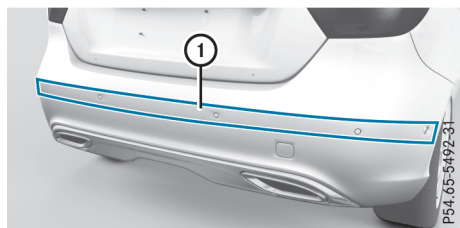
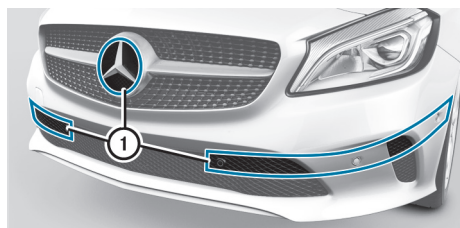

- ▶ Clean sensors ① of the driving systems with water, car shampoo and a soft cloth.

Cleaning the reversing camera

- ❗ Do not clean the camera lens and the area around the reversing camera with a high-pressure cleaner.

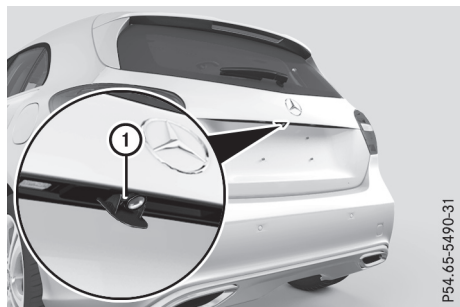

- ▶ Make sure that the vehicle is at a standstill and the key is in position ② in the ignition lock.
- ▶ Open the camera cover for cleaning, via the multimedia system; see Digital Owner's Manual.
- ▶ **To clean the reversing camera:** use clean water and a soft cloth to clean camera lens ①.

Cleaning the exhaust pipes

⚠ WARNING

The exhaust tail pipe and tail pipe trim can become very hot. If you come into contact with these parts of the vehicle, you could burn yourself. There is a risk of injury.

Always be particularly careful around the exhaust tail pipe and the tail pipe trim. Allow these components to cool down before touching them.

- ❗ Do not clean the exhaust pipe with acid-based cleaning agents, such as sanitary cleanser or wheel cleaner.
- ❗ Mercedes-AMG vehicles with black exhaust pipes: the black-chrome tailpipe finishers should not be polished with a chrome polish. They will otherwise lose their black sheen. For optimal care, the finishers should be rubbed with a lightly oiled cloth after every car wash. Commercially available engine and care oils are suitable for this.

For heavier soiling, you can apply a fine paintwork polish with a microfibre cloth. Remove the excess polish residue after polishing.

Impurities combined with the effects of road grit and corrosive environmental factors may cause flash rust to form on the surface. You can restore the original shine of the exhaust pipe by cleaning it regularly, especially in winter and after washing the vehicle.

- ▶ Clean the exhaust pipe with a care product tested and approved by Mercedes-Benz.

Cleaning the trailer tow hitch

🌿 Environmental note

Dispose of oily and greasy cloths in an environmentally-responsible manner.

! Do not clean the ball coupling with a high-pressure cleaner. Do not use solvents.

! Please note the care instructions in the trailer coupling manufacturer's operating instructions.

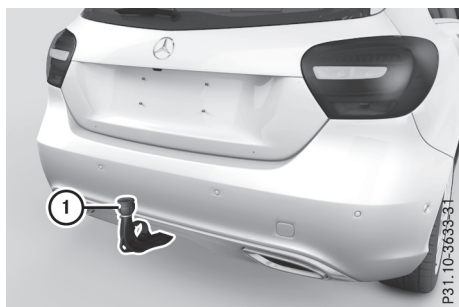

- ▶ Remove rust, e.g. with a wire brush.
- ▶ Remove dirt with a clean, lint-free cloth or a brush.
- ▶ After cleaning, lightly oil or grease ball coupling ①.
- ▶ Check that the vehicle's trailer tow hitch is working properly.

i You can also have the maintenance work on the ball coupling and the trailer tow hitch carried out by a qualified specialist workshop.

Interior care

Cleaning the display

! For cleaning, do not use any of the following:

- alcohol-based thinner or petrol
- abrasive cleaning agents
- commercially-available household cleaning agents

These may damage the display surface. Do not put pressure on the display surface when cleaning. This could lead to irreparable damage to the display.

- ▶ Before cleaning the display, make sure that it is switched off and has cooled down.
- ▶ Clean the display surface using a commercially available microfibre cloth and TFT/LCD display cleaner.
- ▶ Dry the display surface using a dry microfibre cloth.

Cleaning the plastic trim

! WARNING

Care products and cleaning agents containing solvents can cause surfaces in the cockpit to become porous. This could result in plastic parts breaking away when the airbags are deployed. There is a danger of injury.

Do not use care products and cleaning agents containing solvents to clean the cockpit.

! Never attach the following to plastic surfaces:

- stickers
- films
- perfume oil container or similar

You could otherwise damage the plastic.

! Do not allow cosmetics, insect repellent or sunscreen to come in contact with the plastic trim. This maintains the high-quality look of the surfaces.

- ▶ Wipe the plastic trim with a damp, lint-free cloth, e.g. a microfibre cloth.
- ▶ **Heavy soiling:** use care and cleaning products recommended and approved by Mercedes-Benz. The surface may change colour temporarily. Wait until the surface is dry again.

Cleaning the steering wheel and gear lever or selector lever

- ▶ Thoroughly wipe with a damp cloth or use leather care agents that have been recommended and approved by Mercedes-Benz.

Cleaning wood trim and trim elements

! Do not use solvent-based cleaning agents such as tar remover, wheel cleaners, polishes or waxes. There is otherwise a risk of damaging the surface.

- ▶ Wipe the wooden trim and trim elements with a damp, lint-free cloth, e.g. a microfibre cloth.
- ▶ **Heavy soiling:** use car care and cleaning products recommended and approved by Mercedes-Benz.

Cleaning the seat covers

General notes

! Do not use a microfibre cloth to clean covers made out of real leather, artificial leather or DINAMICA. If used frequently, this can damage the cover.

Note that regular care is essential to make sure that the appearance and comfort of the covers are retained over time.

Genuine leather seat covers

! To retain the natural appearance of the leather, observe the following cleaning instructions:

- Clean genuine leather covers carefully with a damp cloth and then wipe the covers down with a dry cloth.
- Make sure that the leather does not become soaked. It may otherwise become rough and cracked.
- Only use leather care agents that have been tested and approved by Mercedes-Benz. You can obtain these from a qualified specialist workshop.

Leather is a natural product.

It has natural surface properties, e.g.:

- unevenness in structure
- marks caused by growth and injury
- subtle colour differences

These are characteristics of leather and not material faults.

Seat covers from other materials

! Observe the following when cleaning:

- clean artificial leather covers with a cloth moistened with a solution containing 1% detergent (e.g. washing-up liquid).
- clean cloth covers with a microfibre cloth moistened with a solution containing 1% detergent (e.g. washing-up liquid). Rub carefully, and always wipe entire seat sections to avoid leaving visible lines. Leave the seat to dry afterwards. Cleaning results depend on the type of dirt and how long it has been there.
- Clean DINAMICA covers with a damp cloth. Make sure that you wipe entire seat sections to avoid leaving visible lines.

Cleaning the seat belts

WARNING

Seat belts may be severely weakened if bleached or coloured. This may lead to the seat belts, for example, tearing or failing in an accident. There is an increased risk of injury, possibly even fatal.

Never bleach or colour seat belts.

! Do not clean the seat belts using chemical cleaning agents. Do not dry the seat belts at temperatures above 80 °C or in direct sunlight.

- ▶ Use clean, lukewarm water and soap solution.

Cleaning the roof lining and carpets

- ▶ **Roof lining:** if it is very dirty, use a soft brush or dry shampoo.
- ▶ **Carpets:** use the carpet and textile cleaning agents recommended and approved by Mercedes-Benz.

Where will I find...?

Reflective safety jacket

Removing and stowing the reflective safety jacket

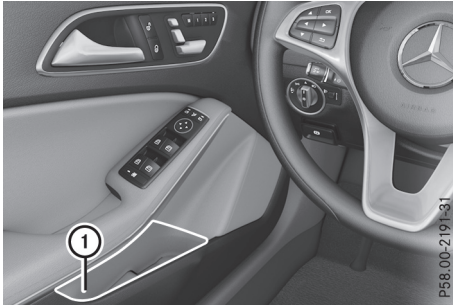

The reflective safety jackets are located in front door stowage compartments ①. Reflective safety jackets can also be stored in the rear door stowage compartments.

- ▶ **To remove:** pull out the safety jacket bag containing the reflective safety jacket.
 - ▶ Open the safety jacket bag and pull out the reflective safety jacket.
 - ▶ **To stow:** fold the reflective safety jacket, roll it up and stow it in the safety jacket bag.
 - ▶ Replace the safety jacket bag into stowage compartment ①.
- i** Remove a new reflective safety jacket from its packaging material before sliding it into the stowage compartment. The packaging material may otherwise cause it to slip out or make removing it difficult.

Observe the legal requirements for each individual country.

Notes on reflective safety jackets

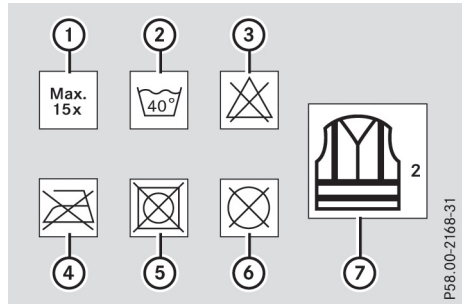

- ① Maximum number of washes
- ② Maximum wash temperature
- ③ Do not bleach
- ④ Do not iron
- ⑤ Do not use a tumble dryer
- ⑥ Do not dry-clean
- ⑦ This is a class 2 jacket

- The reflective safety jackets meet the requirements defined by the legal standard only:
 - if the correct size is used and
 - if the reflective safety jackets are correctly fastened
- Before use, ensure that the reflective safety jackets are clean and intact. The special properties may otherwise be compromised.
- The reflective safety jackets should be stored in their original packaging in a dry place away from sources of heat and light.
- The maximum number of washes specified is not the only factor influencing the life span of the reflective safety jackets. Their life span also depends on use, care, storage etc.
- The reflective safety jackets should be disposed of and replaced with new ones:
 - after 15 washes, and/or
 - if the reflective strips have become scratched, and/or
 - if the backing material and/or reflective strips have become soiled with dirt that cannot be cleaned off, and/or
 - the fluorescence has faded e.g. due to the effects of sunlight
- Dispose of reflective safety jackets in an environmentally responsible manner. To do so, contact your local waste disposal company.

Warning triangle

Removing/replacing the warning triangle



P68.00-7823-31

- ▶ **To remove:** open the tailgate.
- ▶ Lift the luggage compartment floor upwards (> page 276).
- ▶ To release warning triangle ①, push back the retainers on the bracket.
- ▶ Remove warning triangle ① from the bracket.
- ▶ **To replace:** place warning triangle ① back into the bracket and push down to secure.
- ▶ Fold down the luggage compartment floor.
- ▶ Close the tailgate.

Setting up the warning triangle

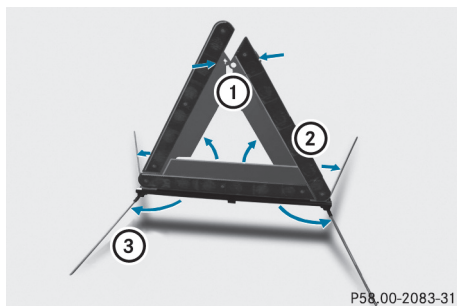

P58.00-2083-31

- ▶ Fold feet ③ out to the side.
- ▶ Fold side reflectors ② upwards to form a triangle and lock them at the top using press stud ①.

First-aid kit



P68.00-8278-31

- ▶ Open the tailgate.
- ▶ Lift the boot floor upwards.
- ▶ Remove the first-aid kit ①.

Check the expiry date on the first-aid kit at least once a year. Replace the contents if necessary, and replace any missing items.

Fire extinguisher

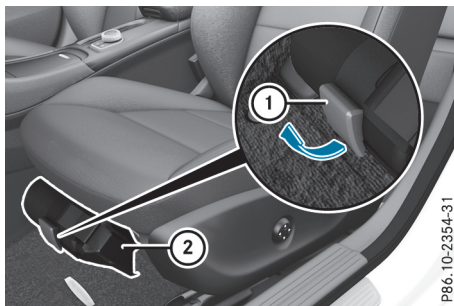

P86.10-2354-31

The fire extinguisher is located underneath the front of the driver's seat.

- ▶ Pull tab ① upwards.
- ▶ Remove fire extinguisher ②.

Have the fire extinguisher refilled after each use and checked every one or two years. It may otherwise fail in an emergency.

Observe the legal requirements for each individual country.

Vehicle tool kit

General notes

Vehicles with a TIREFIT kit: the TIREFIT kit is located in the stowage well under the luggage compartment floor.

Vehicles with a tyre-change tool kit: the tyre-change tool kit is in the stowage well under the luggage compartment floor.

Apart from some country-specific variants, vehicles are not equipped with a tyre-change tool kit. Some tools for changing a wheel are specific to the vehicle. For more information on which tyre-changing tools are required and approved for performing a tyre change on your vehicle, consult a qualified specialist workshop.

Necessary tyre-changing tools can include, for example:

- jack
- wheel chock
- wheel wrench
- centring pin

i The jack weighs approximately 3.4 kg.

The maximum load-bearing capacity of the jack can be found on the adhesive label on the jack.

The jack is maintenance-free. If it develops a fault, please contact a qualified specialist workshop.

Vehicles with a TIREFIT kit

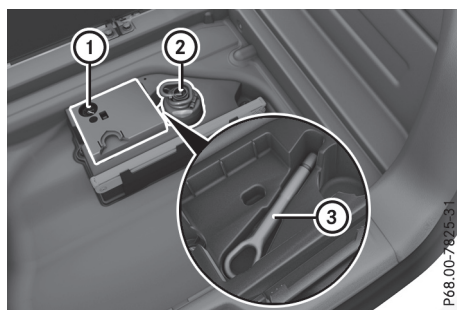

- ① Tyre inflation compressor
- ② Tyre sealant bottle
- ③ Towing eye

- ▶ Open the tailgate.
- ▶ Swing the luggage compartment floor upwards (▷ page 276).
- ▶ Use the TIREFIT kit (▷ page 301) or remove it. Towing eye ③ is located under tyre inflation compressor ①.

i Example: equipment and country-specific variations possible.

i The tyre inflation compressor weighs approximately 0.8 kg.

At a distance of approximately 1 m from the tyre inflation compressor and approximately 1.6 m above the ground, the following sound pressure levels apply:

- Emissions sound pressure level L_{pA} 79 dB(A)
- Sound power level L_{WA} 88 dB(A)

The tyre inflation compressor is maintenance-free. If it develops a fault, please contact a qualified specialist workshop.

Vehicles with a tyre-change tool kit

- ▶ Open the tailgate.
- ▶ Swing the luggage compartment floor upwards (▷ page 276).
- ▶ Remove the tyre-change tool kit.

The tyre-change tool kit contains:

- jack
- wheel wrench
- pair of gloves
- folding wheel chock

Flat tyre

Preparing the vehicle

Your vehicle may be equipped with:

- MOExtended tyres (tyres with run-flat characteristics) (▷ page 300)

Vehicle preparation is not necessary on vehicles with MOExtended tyres.

- a TIREFIT kit (▷ page 299)

Vehicles with MOExtended tyres are not equipped with a TIREFIT kit at the factory. It is therefore recommended that you additionally equip your vehicle with a TIREFIT kit if you fit tyres that do not feature run-flat characteristics, e.g. win-

ter tyres. A TIREFIT kit can be obtained from a qualified specialist workshop.

Information on changing and fitting a wheel (▷ page 324).

- ▶ Stop the vehicle as far away as possible from traffic on solid, non-slippery and level ground.
- ▶ Switch on the hazard warning lamps.
- ▶ Secure the vehicle against rolling away (▷ page 157).
- ▶ If possible, bring the front wheels into the straight-ahead position.
- ▶ Switch off the engine.
- ▶ **Vehicles without KEYLESS-GO:** remove the key from the ignition lock.
- ▶ **Vehicles with KEYLESS-GO start-function or KEYLESS-GO:** open the driver's door. The vehicle electronics are now in position . This is the same as the key having been removed.
- ▶ **Vehicles with KEYLESS-GO start function or KEYLESS-GO:** remove the Start/Stop button from the ignition lock (▷ page 135).
- ▶ Make sure that the passengers are not endangered as they get out of the vehicle. Make sure that no one is near the danger area while a wheel is being changed. Anyone who is not directly assisting in the wheel change should, for example, stand behind the barrier.
- ▶ Get out of the vehicle. Pay attention to traffic conditions when doing so.
- ▶ Close the driver's door.
- ▶ Place the warning triangle a suitable distance away (▷ page 298). Observe legal requirements.

MOExtended tyres (tyres with run-flat characteristics)

General notes

With MOExtended tyres (tyres with run-flat characteristics), you can continue to drive your vehicle even if there is a total loss of pressure in one or more tyres. The affected tyre must not show any clearly visible damage.

You can recognise MOExtended tyres by the "MOExtended" mark that appears on the tyre sidewall. You will find this mark next to the tyre size designation, the load-bearing capacity and the speed index.

MOExtended tyres may be used only in conjunction with an activated tyre pressure loss warning system or tyre pressure monitor.

If a pressure loss warning message appears in the multifunction display:

- observe the instructions in the display messages (▷ page 240)
- check the tyre for damage
- if driving on, observe the following notes

The driving distance possible in run-flat mode is approximately 80 km when the vehicle is partially laden and approximately 30 km when the vehicle is fully laden.

In addition to the vehicle load, the driving distance possible in run-flat mode depends on the:

- vehicle speed
- road condition
- outside temperature

The driving distance possible in run-flat mode may be reduced by extreme driving conditions/manoeuvres, or it can be increased through a moderate style of driving.

The driving distance possible in run-flat mode is counted from the moment the tyre pressure loss warning appears on the multifunction display.

You must not exceed a maximum speed of 80 km/h.

When replacing one or all tyres, observe the following specifications for your vehicle's tyres:

- size
- type and
- the "MOExtended" marking

If a tyre has gone flat and cannot be replaced with an MOExtended tyre, a standard tyre may be used as a temporary measure. Make sure that you use the proper size and type (summer or winter tyre).

Vehicles with MOExtended tyres are not equipped with a TIREFIT kit at the factory. It is therefore recommended that you additionally equip your vehicle with a TIREFIT kit if you fit tyres that do not feature run-flat characteristics, e.g. winter tyres. A TIREFIT kit can be obtained from a qualified specialist workshop.

Important safety notes

WARNING

When driving in emergency mode, the driving characteristics deteriorate, e.g. when corner-

ing, accelerating quickly and when braking. There is a risk of accident.

Do not exceed the stated maximum speed. Avoid abrupt steering and driving manoeuvres, and driving over obstacles (kerbs, pot-holes, off-road). This applies in particular to a laden vehicle.

Stop driving in emergency mode if:

- you hear banging noises.
- the vehicle starts to shake.
- you see smoke and smell rubber.
- ESP® is intervening constantly.
- there are tears in the sidewalls of the tyre.

After driving in emergency mode, have the wheel rims checked at a qualified specialist workshop with regard to their further use. The faulty tyre must be replaced.

TIREFIT kit

Important safety notes

TIREFIT is a tyre sealant.

You can use TIREFIT to seal punctures of up to 4 mm, particularly those in the tyre tread. You can use TIREFIT at outside temperatures down to -20 °C.

WARNING

In the following situations, the tyre sealant is unable to provide sufficient breakdown assistance, as it is unable to seal the tyre properly:

- there are cuts or punctures in the tyre larger than those mentioned above.
- the wheel rim is damaged.
- you have driven at very low tyre pressures or on a flat tyre.

There is a risk of an accident.

Do not drive any further. Contact a qualified specialist workshop.

WARNING

The tyre sealant is harmful and causes irritation. It must not come into contact with your skin, eyes or clothing or be swallowed. Do not

inhale TIREFIT fumes. Keep tyre sealant away from children. There is a risk of injury.

If you come into contact with the tyre sealant, observe the following:

- Rinse off the tyre sealant from your skin immediately with water.
- If the tyre sealant comes into contact with your eyes, immediately rinse them thoroughly with clean water.
- If tyre sealant is swallowed, immediately rinse your mouth out thoroughly and drink plenty of water. Do not induce vomiting, and seek medical attention immediately.
- Immediately change out of clothing which has come into contact with tyre sealant.
- If an allergic reaction occurs, seek medical attention immediately.

 After use, excess tyre sealant may run out of the filler hose. This could cause stains.

Therefore, place the filler hose in the plastic bag which contained the TIREFIT kit.

Environmental note

Have the used tyre sealant bottle disposed of professionally, e.g. at a qualified specialist workshop.

 Do not operate the tyre inflation compressor for longer than ten minutes at a time without a break. It may otherwise overheat.

The tyre inflation compressor can be operated again once it has cooled down.

Comply with the manufacturer's safety notes on the sticker on the tyre inflation compressor.

Using the TIREFIT kit

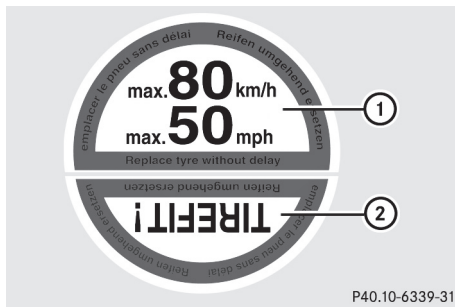

P40.10-6339-31

- ▶ Do not remove any foreign objects that have penetrated the tyre, e.g. screws or nails.
- ▶ Remove the tyre sealant bottle, the accompanying TIREFIT sticker and the tyre inflation compressor from the stowage space underneath the luggage compartment floor (▷ page 299).
- ▶ Affix part ① of the TIREFIT sticker to the instrument cluster within the driver's field of vision.
- ▶ Affix part ② of the TIREFIT sticker near the valve on the wheel with the defective tyre.

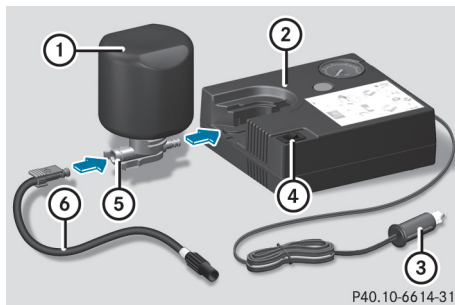

P40.10-6614-31

- ▶ Remove filler hose ⑥ and connector ③ from the bottom section of tyre inflation compressor housing ②.
- ▶ Slide the yellow filler hose connector into the mounting on yellow cap ⑤ of tyre sealant bottle ① until the connector engages.
- ▶ With the sealing rings in front, slide yellow cap ⑤ of tyre sealant bottle ① into the holder of tyre inflation compressor ②. Yellow cap ⑤ must engage in both hooks.

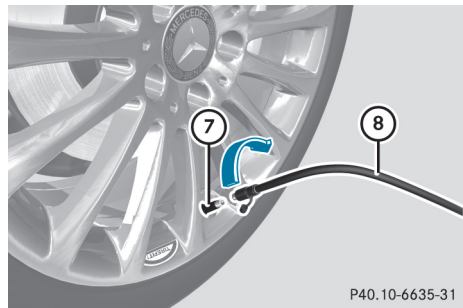

P40.10-6635-31

- ▶ Remove cap from valve ⑦ on the faulty tyre.
- ▶ Screw filler hose ⑧ onto valve ⑦.
- ▶ Insert connector ③ into a 12 V socket in your vehicle.

Observe the notes on sockets (▷ page 280).

- ▶ Turn the key to position ① in the ignition lock (▷ page 135).
- ▶ Press on and off switch ④ on the tyre inflation compressor to **ON**.

The tyre inflation compressor is switched on. The tyre is inflated.

First, tyre sealant is pumped into the tyre. The pressure may briefly rise to approximately 500 kPa (5 bar/73 psi).

Do not switch off the tyre inflation compressor during this phase.

- ▶ Let the tyre inflation compressor run for a maximum of ten minutes. The tyre should then have attained a pressure of at least 200 kPa (2.0 bar/29 psi).

If a pressure of 200 kPa (2.0 bar/29 psi) has been attained after ten minutes, see "Tyre pressure reached" (▷ page 303).

If a tyre pressure of 200 kPa (2.0 bar/29 psi) has not been attained after ten minutes, see "Tyre pressure not reached" (▷ page 303).

If tyre sealant leaks out, make sure you clean the affected area as quickly as possible. It is preferable to use clear water.

If you get tyre sealant on your clothing, have it cleaned as soon as possible with perchloroethylene.

Tyre pressure not reached

If a tyre pressure of 200 kPa (2.0 bar/29 psi) has not been reached after ten minutes:

- ▶ Switch off the tyre inflation compressor.
- ▶ Unscrew the filler hose from the valve of the faulty tyre.
Please note that tyre sealant may leak out when unscrewing the filler hose.
- ▶ Very slowly drive forwards or reverse approximately 10 m.
- ▶ Pump up the tyre again.
After a maximum of ten minutes, the tyre pressure must be at least 200 kPa (2.0 bar/29 psi).

WARNING

If the required tyre pressure is not reached after the specified time, the tyre is too badly damaged. The tyre sealant cannot repair the tyre in this instance. Damaged tyres and a tyre pressure that is too low can significantly impair the vehicle's braking and driving characteristics. There is a risk of accident.

Do not continue driving. Contact a qualified specialist workshop.

Tyre pressure reached

WARNING

A tyre temporarily sealed with tyre sealant impairs the driving characteristics and is not suitable for higher speeds. There is a risk of accident.

You should therefore adapt your driving style accordingly and drive carefully. Do not exceed the specified maximum speed with a tyre that has been repaired using tyre sealant.

The maximum permissible speed for a tyre sealed with tyre sealant is 80 km/h. The upper part of the TIREFIT sticker must be affixed to the instrument cluster where it will be easily seen by the driver.

If a tyre pressure of 200 kPa (2.0 bar/29 psi) has been attained after ten minutes:

- ▶ Switch off the tyre inflation compressor.
- ▶ Unscrew the filler hose from the valve of the faulty tyre.
Please note that tyre sealant may leak out when the filler hose is unscrewed.
- ▶ Stow the tyre sealant bottle, the tyre inflation compressor and the warning triangle.
- ▶ **Pull away immediately.**
- ▶ Stop after driving for approximately ten minutes and check the tyre pressure with the tyre inflation compressor.
The tyre pressure must now be at least 130 kPa (1.3 bar/19 psi).

WARNING

If the required tyre pressure is not reached after driving for a short period, the tyre is too badly damaged. The tyre sealant cannot repair the tyre in this instance. Damaged tyres and a tyre pressure that is too low can significantly impair the vehicle's braking and driving characteristics. There is a risk of accident.

Do not continue driving. Contact a qualified specialist workshop.

 In your vehicle, you will find a sticker with the Mercedes-Benz Service24h telephone number, e.g. on the B-pillar on the driver's side.

- ▶ Correct the tyre pressure if it is still at least 130 kPa (1.3 bar/19 psi). See the tyre pressure table on the fuel filler flap for values.
- ▶ **To increase the tyre pressure:** switch on the tyre inflation compressor.

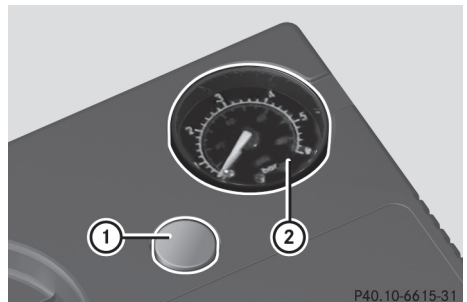

- ▶ **To reduce the tyre pressure:** depress pressure release button ① next to pressure gauge ②.
- ▶ When the tyre pressure is correct, unscrew the filler hose from the valve of the sealed tyre. Please note that tyre sealant may leak out when the filler hose is unscrewed.
- ▶ Screw the valve cap onto the tyre valve of the sealed tyre.

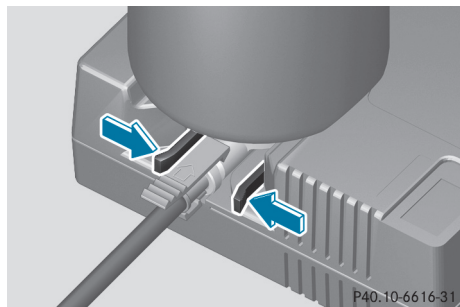

- ▶ To remove the tyre sealant bottle from the tyre inflation compressor, press together the locking tabs on the yellow cap.
- ▶ Pull the tyre sealant bottle out of the tyre inflation compressor. The filler hose stays on the tyre sealant bottle.
- ▶ Drive to the nearest qualified specialist workshop and have the tyre changed there.
- ▶ Have the tyre sealant bottle and the filler hose replaced as soon as possible at a qualified specialist workshop.
- ▶ Have the tyre sealant bottle replaced every four years at a qualified specialist workshop.

Battery (vehicle)

Important safety notes

Work on the battery, e.g. removing or fitting, requires specialist knowledge and the use of special tools. Therefore, always have work on the battery carried out at a qualified specialist workshop.

WARNING

Work carried out incorrectly on the battery can lead, for example, to a short circuit and thus damage the vehicle electronics. This can

lead to function restrictions applying to safety-relevant systems, e.g. the lighting system, the ABS (anti-lock braking system) or the ESP® (Electronic Stability Program). The operating safety of your vehicle may be restricted. You could lose control of the vehicle, for example:

- when braking
- in the event of abrupt steering manoeuvres and/or when the vehicle's speed is not adapted to the road conditions

There is a risk of an accident.

In the event of a short circuit or a similar incident, contact a qualified specialist workshop immediately. Do not drive any further. Always have work on the battery carried out at a qualified specialist workshop.

Further information about ABS (▷ page 65) and ESP® (▷ page 69).

WARNING

Electrostatic build-up can lead to the creation of sparks, which could ignite the highly explosive gases of a battery. There is a risk of an explosion.

Before handling the battery, touch the vehicle body to remove any existing electrostatic build-up.

The highly flammable gas mixture is created while the battery is charging and when jump-starting.

Always make sure that neither you nor the battery is electrostatically charged. Electrostatic charge is created, for example:

- by wearing synthetic-fibre clothing
- by friction between clothing and the seat
- if you pull or push the battery across carpet or other synthetic materials
- if you rub the battery with a cloth

WARNING

During the charging process, a battery produces hydrogen gas. If a short circuit occurs or sparks are created, the hydrogen gas can ignite. There is a risk of an explosion.

- Make sure that the positive terminal of a connected battery does not come into contact with vehicle parts.
- Never place metal objects or tools on a battery.
- It is important that you observe the described order of the battery terminals when connecting and disconnecting a battery.
- When jump-starting, make sure that the battery poles with identical polarity are connected.
- It is particularly important to observe the described order when connecting and disconnecting the jump leads.
- Never connect or disconnect the battery terminals while the engine is running.

WARNING

Battery acid is caustic. There is a risk of injury. Avoid contact with the skin, eyes or clothing. Do not breathe in any battery gases. Do not lean over the battery. Keep the batteries out of the reach of children. Immediately rinse off battery acid thoroughly with plenty of clean water and seek medical attention at once.

Environmental note



Batteries contain pollutants. It is illegal to dispose of them with the household rubbish. They must be collected separately and disposed of in an environmentally responsible recycling system.



Dispose of batteries in an environmentally responsible manner. Take discharged batteries to a qualified specialist workshop or to a collection point for used batteries.

! Have the battery regularly checked at a qualified specialist workshop.

Observe the service intervals in the Service Booklet or contact a qualified specialist workshop for more information.

! Always have work on the battery carried out at a qualified specialist workshop. Should it, in exceptional circumstances, be absolutely necessary to disconnect the battery yourself, please observe the following:

- switch off the engine and remove the key. On vehicles with KEYLESS-GO, make sure that the ignition is switched off. Check that all the indicator lamps on the instrument cluster are off. Otherwise, you may damage electronic components such as the alternator, for example.
- first, disconnect the negative terminal clamp, followed by the positive terminal clamp. Never swap the terminal clamps. The vehicle electronics may otherwise be damaged.
- in vehicles with automatic transmission, the transmission is locked in position **P** after the battery is disconnected. The vehicle is secured against rolling away. You cannot move the vehicle.

The battery and the cover of the positive terminal clamp must be fitted securely during operation.

Comply with safety precautions and take protective measures when handling batteries.



Risk of explosion.



Fire, naked flames and smoking are prohibited when handling the battery. Avoid creating sparks.



Battery acid is caustic. Avoid contact with the skin, eyes and clothing.

Wear suitable protective clothing; in particular, gloves, an apron and a face mask.

Immediately rinse acid splashes off with clean water. Consult a doctor if necessary.

Wear eye protection.





Keep children at a safe distance.



Observe this Owner's Manual.

For safety reasons, Mercedes-Benz recommends that you only use batteries which have been tested and approved for your vehicle by Mercedes-Benz. These batteries provide increased impact protection to prevent vehicle occupants from suffering acid burns should the battery be damaged in the event of an accident. In order for the battery to achieve the maximum possible service life, it should always be sufficiently charged.

Like other batteries, the vehicle battery may discharge over time if you do not use the vehicle. In such cases, have the battery disconnected at a qualified specialist workshop. However, you can also charge the battery with a charger recommended by Mercedes-Benz. For more information, please contact a qualified specialist workshop.

Have the battery charge checked more frequently if you use the vehicle mainly for short trips or if you leave it standing idle for an extended period. Consult a qualified specialist workshop if you wish to leave your vehicle parked up for a long period of time.

When you park the vehicle, remove the key if you do not require any electrical consumers. The vehicle will then use very little energy, thus conserving battery power.

If the power supply has been interrupted, e.g. if the battery was discharged, you will have to:

- set the clock using the multimedia system (see the Digital Owner's Manual)
- reset the function for folding the exterior mirrors in/out automatically, by folding the mirrors out once (▷ page 104)

Charging the battery

WARNING

During charging and jump-starting, explosive gases can escape from the battery. There is a risk of an explosion.

Particularly avoid fire, naked flames, creating sparks and smoking. Ensure there is sufficient ventilation while charging and jump-starting. Do not lean over a battery.

WARNING

Battery acid is caustic. There is a risk of injury. Avoid contact with the skin, eyes or clothing. Do not breathe in any battery gases. Do not lean over the battery. Keep the batteries out of the reach of children. Immediately rinse off battery acid thoroughly with plenty of clean water and seek medical attention at once.

WARNING

A discharged battery can freeze at temperatures below freezing point. When jump-starting the vehicle or charging the battery, gases can escape from the battery. There is a risk of an explosion.

Allow the frozen battery to thaw out before charging it or jump-starting.

 Only use battery chargers with a maximum charging voltage of 14.8 V.

 Only charge the battery using the jump-start connection point.

The jump-starting connection point is in the engine compartment (▷ page 307).

► Open the bonnet.

► Connect the battery charger to the positive terminal and earth point in the same order as when connecting the donor battery in the jump-starting procedure (▷ page 307).

If the indicator/warning lamps do not light up in the instrument cluster at low temperatures, it is very likely that the discharged battery has frozen. In this case, you may neither jump-start the vehicle nor charge the battery. The service life of a battery that has been thawed may be reduced. The starting characteristics may be impaired, especially at low temperatures. Have the thawed battery checked at a qualified specialist workshop.

Only charge the installed battery with a battery charger which has been tested and approved by Mercedes-Benz. A battery charger unit specially adapted for Mercedes-Benz vehicles and tested and approved by Mercedes-Benz is available as

an accessory. This device permits charging of the battery while it is installed. Contact a Mercedes-Benz Service Centre for information

and availability. Read the battery charger's operating instructions before charging the battery.

Jump-starting

For the jump-starting procedure, use only the jump-starting connection point, consisting of a positive terminal and an earth point, in the engine compartment.

WARNING

Battery acid is caustic. There is a risk of injury.

Avoid contact with the skin, eyes or clothing. Do not breathe in any battery gases. Do not lean over the battery. Keep the batteries out of the reach of children. Immediately rinse off battery acid thoroughly with plenty of clean water and seek medical attention at once.

WARNING

During charging and jump-starting, explosive gases can escape from the battery. There is a risk of an explosion.

Particularly avoid fire, naked flames, creating sparks and smoking. Ensure there is sufficient ventilation while charging and jump-starting. Do not lean over a battery.

WARNING

During the charging process, a battery produces hydrogen gas. If a short circuit occurs or sparks are created, the hydrogen gas can ignite. There is a risk of an explosion.

- Make sure that the positive terminal of a connected battery does not come into contact with vehicle parts.
- Never place metal objects or tools on a battery.
- It is important that you observe the described order of the battery terminals when connecting and disconnecting a battery.
- When jump-starting, make sure that the battery poles with identical polarity are connected.
- It is particularly important to observe the described order when connecting and disconnecting the jump leads.
- Never connect or disconnect the battery terminals while the engine is running.

WARNING

A discharged battery can freeze at temperatures below freezing point. When jump-starting the vehicle or charging the battery, gases can escape from the battery. There is a risk of an explosion.

Allow the frozen battery to thaw out before charging it or jump-starting.

! **Vehicles with a petrol engine:** avoid repeated and lengthy starting attempts. Otherwise, the non-combusted fuel may damage the catalytic converter.

If the indicator / warning lamps do not light up in the instrument cluster at low temperatures, it is very likely that the discharged battery has frozen. In this case you may neither jump-start the vehicle nor charge the battery. Let the battery thaw first. The service life of a battery that has been thawed may be reduced. The starting characteristics may be impaired, especially at low temperatures. Have the thawed battery checked at a qualified specialist workshop.

Do not use a rapid charging device to start the vehicle. If your vehicle's battery is discharged, the engine can be jump-started from another vehicle or from a donor battery using jump leads. Observe the following points:

- the battery is not accessible in all vehicles. If the other vehicle's battery is not accessible, jump-start the vehicle using a donor battery or a jump-starting device
- **vehicles with a petrol engine:** jump-start the vehicle only when the engine and exhaust system are cold
- do not start the engine if the battery is frozen. Let the battery thaw first
- jump-starting may be performed only using batteries with a nominal voltage of 12 V
- only use jump leads that are not damaged and have a sufficient cross-section and insulated terminal clamps.
- make sure that the two vehicles do not touch

Make sure that:

- the jump leads are not damaged
 - non-insulated parts of the terminal clamps do not come into contact with other metal parts while the jump leads are connected to the battery
 - the jump leads cannot come into contact with parts that can move when the engine is running, such as the V-belt pulley or the fan
- ▶ Secure the vehicle by applying the electric parking brake.
- ▶ **Manual transmission:** depress the clutch pedal fully and shift to neutral.
- ▶ **Automatic transmission:** shift the transmission to position **P**.
- ▶ Turn the key to position **0** in the ignition lock and remove it.
- ▶ Switch off all electrical consumers, e.g. rear window heating, lighting etc.
- ▶ Open the bonnet.

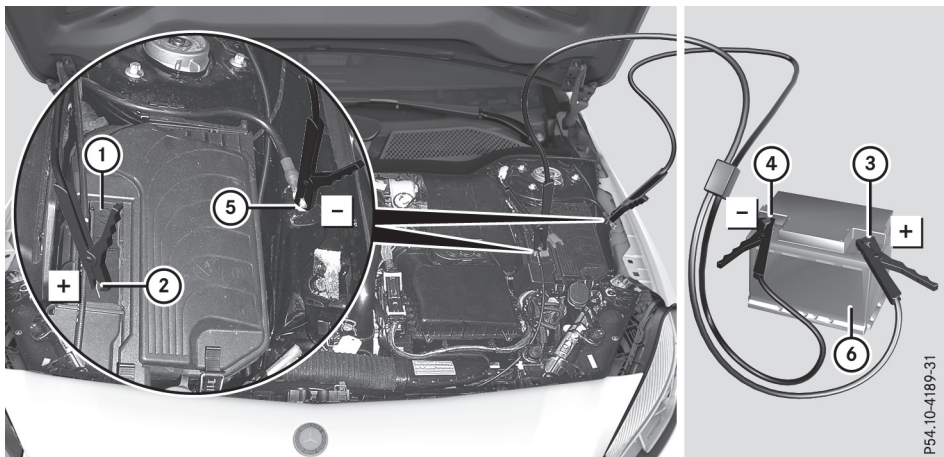

Position number ⑥ identifies the charged battery of the other vehicle or an equivalent jump-starting device.

- ▶ Press together cover ① of positive clamp ② and slide it back.
- ▶ Connect positive terminal ② on your vehicle to positive terminal ③ of donor battery ⑥ using the jump lead.
- ▶ Start the engine of the donor vehicle and run it at idling speed.

- ▶ Connect negative terminal ④ of donor battery ⑥ to earth point ⑤ of your vehicle using the jump lead. Connect the jump lead to donor battery ⑥ first.
 - ▶ if the battery is fully discharged, leave the battery that is being used to jump-start connected for a few minutes before attempting to start. This charges the empty battery a little
 - ▶ Start the engine.
 - ▶ Before disconnecting the jump leads, let the engines run for several minutes.
 - ▶ First, remove the jump leads from earth point ⑤ and negative terminal ④, then from positive clamp ② and positive terminal ③. Each time, begin at the contacts on your own vehicle.
 - ▶ Close cover ① of positive clamp ② after removing the jump leads.
 - ▶ Close the bonnet.
 - ▶ Have the battery checked at a qualified specialist workshop.
- i** Jump-starting is not considered to be a normal operating condition.
- i** Jump-starting cables and further information regarding jump-starting can be obtained at any qualified specialist workshop.

Towing and tow-starting

Important safety notes

WARNING

Safety relevant functions are restricted or no longer available if:

- the engine is not running
- the brake system or power steering is malfunctioning
- there is a malfunction in the voltage supply or the vehicle's electrical system

When your vehicle is towed away or towed started, you may require considerably more effort to steer and brake. There is a risk of an accident.

In such cases use a rigid towing bar. Before being towed away or tow started, make sure the steering moves freely.

WARNING

If the steering wheel lock is engaged, the vehicle can no longer be steered. There is a risk of an accident.

Always switch on the ignition when towing with a tow rope or a towing bar.

WARNING

When towing or tow-starting another vehicle and its weight is greater than the permissible gross weight of your vehicle, the:

- towing eye may be torn off
- car/trailer combination may swerve or even overturn

There is a risk of an accident.

When towing or tow-starting another vehicle, its weight should not be greater than the permissible gross weight of your vehicle.

Details on the permissible gross vehicle weight of your vehicle can be found on the vehicle identification plate (▷ page 333).

- !** When Active Brake Assist, Distance Pilot DISTRONIC or the HOLD function is activated, the vehicle brakes automatically in certain situations.

To avoid damage to the vehicle, deactivate these systems in the following or similar situations:

- when towing away
- in a car wash

- !** Make sure that the electric parking brake is released. If the electric parking brake is faulty, visit a qualified specialist workshop.

- !** Only secure the tow cable or tow bar to the towing eyes or, if available, to the trailer tow

hitch. You could otherwise damage the vehicle.

- !** Observe the following points when towing with a tow rope:
 - Secure the tow rope on the same side on both vehicles.
 - Make sure that the tow rope is not longer than legally permitted. Mark the tow rope in the middle, e.g. with a white cloth (30 x 30 cm). This will make other road users aware that a vehicle is being towed.
 - Only secure the tow cable to the towing eyes or, if available, to the trailer tow hitch.
 - Observe the brake lamps of the towing vehicle while driving. Always maintain a distance a distance so that the tow rope does not sag.
 - Do not use steel cables or chains to tow your vehicle. You could otherwise damage the vehicle.

! Do not use the towing eyes for recovery purposes as this could damage the vehicle. If in doubt, recover the vehicle with a crane.

! Pull away smoothly when towing away or tow-starting a vehicle. If the tractive power is too high, the vehicles could be damaged.

! You may tow the vehicle for a maximum of 50km. A towing speed of 50 km/h must not be exceeded.

For towing distances over 50 km, the front axle or the entire vehicle must be raised and transported.

! When towing away vehicles with KEYLESS-GO, use the key instead of the Start/Stop button. The automatic transmission may otherwise shift to position **P** when you open the driver's or front-passenger door, which could damage the transmission.

! Vehicles with automatic transmission must not be tow-started. The transmission may otherwise be damaged.

Observe the legal requirements for the relevant countries when towing and tow-starting.

It is better to have the vehicle transported than to have it towed.

If the vehicle can no longer be driven because of an accident or breakdown, you have the following options:

- transporting the vehicle

As a rule, you should have the vehicle transported.

- towing the vehicle with a tow rope or tow bar
Only tow the vehicle in exceptional cases. The battery must be connected and charged. Otherwise, you:

- cannot turn the key to position **2** in the ignition lock
- cannot release the electric parking brake
- cannot shift the transmission to position **N** on **vehicles with automatic transmission**

The function of the electric parking brake and the parking lock is dependent on the on-board voltage.

If the on-board voltage is low or if there is a system malfunction:

- it may not be possible to apply the released parking brake or
- it may no longer be possible to shift the transmission to position **P**

Switch off non-essential consumers, e.g. the radio.

Deactivate the automatic locking feature before towing the vehicle (> page 213). You could otherwise be locked out when pushing or towing the vehicle.

Deactivate tow-away protection before the vehicle is towed (> page 74).

Fitting/removing the towing eye

Fitting the towing eye

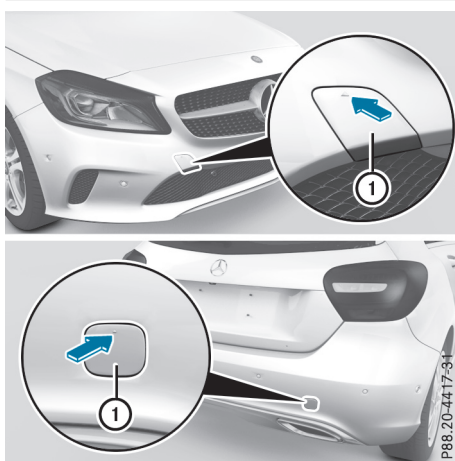

The brackets for the screw-in towing eye are located in the bumpers. They are located at the rear and at the front, under covers ①.

- ▶ Remove the towing eye from the stowage space.
The towing eye is located with the vehicle tool kit under the luggage compartment floor (▷ page 299).
Vehicles with a TIREFIT kit: the towing eye is located under the tyre inflation compressor (▷ page 299).
- ▶ Press the mark on cover ① inwards in the direction of the arrow.
- ▶ Remove cover ① from the opening.
- ▶ Screw in the towing eye clockwise to the stop.

Vehicles with a trailer tow hitch only have a bracket at the front for the screw-in towing eye. If you intend to use the vehicle for towing, fold out the ball coupling (▷ page 198) and secure the towbar to it.

Removing the towing eye

- ▶ Loosen the towing eye and unscrew it.
- ▶ Position cover ① on top of the opening in the bumper and press it in at the bottom until it engages.
- ▶ Place the towing eye in the stowage well under the luggage compartment floor (▷ page 299).
- ▶ Vehicles with a TIREFIT kit: replace the tyre inflation compressor (▷ page 299).

Towing the vehicle with the front axle raised

When towing your vehicle with the front axle raised, it is important that you observe the safety instructions (▷ page 309).

Only vehicles without 4MATIC can be towed with the front axle raised.

! Vehicles with 4MATIC must not be towed with the front or rear axle raised; otherwise, the transmission may be damaged.

Vehicles with 4MATIC may either be towed with both axles on the ground or be loaded and transported.

! The ignition must be switched off if you are towing the vehicle with the front axle raised.

Intervention by ESP® could otherwise damage the brake system.

- ▶ **On vehicles with KEYLESS-GO or the KEYLESS-GO start function:** you must use the key instead of the Start/Stop button (▷ page 136).
 - ▶ Make sure that the vehicle is stationary.
 - ▶ Turn the key to position **2** in the ignition lock.
 - ▶ When the vehicle is stationary, depress the brake pedal and keep it depressed.
 - ▶ **Vehicles with automatic transmission:** shift the automatic transmission to position **P**.
- or
- ▶ **Vehicles with manual transmission:** depress the clutch pedal fully and shift to neutral.
 - ▶ Release the brake pedal.
 - ▶ Release the electric parking brake.
 - ▶ Deactivate tow-away protection (▷ page 74).
 - ▶ Deactivate automatic locking (▷ page 213).
 - ▶ Switch on the hazard warning lamps (▷ page 109).
 - ▶ Turn the key in the ignition lock to position **0** and leave the key in the ignition lock.

Towing the vehicle away with all wheels on the ground

It is important that you observe the safety instructions when towing away your vehicle (▷ page 309).

- ▶ **On vehicles with KEYLESS-GO or the KEYLESS-GO start function:** you must use the key instead of the Start/Stop button (▷ page 136).

Vehicles with automatic transmission: The automatic transmission automatically shifts to position **P** when you open the driver's or front-passenger door or when you remove the key from the ignition lock. In order to ensure that the automatic transmission stays in position **N** when towing away the vehicle, you must observe the following points:

- ▶ Make sure that the vehicle is stationary.
- ▶ Turn the key to position **2** in the ignition lock.

- ▶ Depress the brake pedal and keep it depressed.
- ▶ Shift the automatic transmission to position **N**.

Vehicles with manual transmission:

- ▶ Turn the key to position **2** in the ignition lock.
- ▶ When the vehicle is stationary, depress the brake pedal and keep it depressed.
- ▶ Depress the clutch pedal fully and engage neutral.

Vehicles with manual or automatic transmission:

- ▶ Leave the key in position **2** in the ignition lock.
- ▶ Release the brake pedal.
- ▶ Release the electric parking brake.
- ▶ Switch on the hazard warning lamps (> page 109).

i In order to signal a change of direction when towing the vehicle with the hazard warning lamps switched on, use the combination switch as usual. In this case, only the turn signals for the desired direction flash. When you reset the combination switch, the hazard warning lamps start flashing again.

Transporting the vehicle

Vehicles with automatic transmissions

! When the vehicle is loaded for transport, the front and rear axles must be stationary and on the same transportation vehicle. Positioning over the connection point of the transport vehicle is not permitted. The drive train may otherwise be damaged.

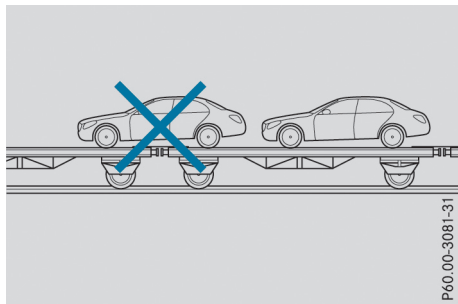

P60.00-3081-31

All vehicles

- !** You may only secure the vehicle by the wheels, not by parts of the vehicle such as axle or steering components. Otherwise, the vehicle could be damaged.
- ▶ **Vehicles with manual transmissions:** depress the clutch pedal fully and engage neutral.
- ▶ Turn the key to position **2** in the ignition lock (> page 135).
- ▶ **Vehicles with automatic transmissions:** turn the key to position **2** in the ignition lock (> page 135).
- ▶ Shift the transmission to position **N**.

As soon as the vehicle is loaded:

- ▶ Secure the vehicle against rolling away by applying the electric parking brake.
- ▶ **Vehicles with manual transmissions:** fully depress the clutch pedal and engage first or reverse gear.
- ▶ **Vehicles with automatic transmissions:** shift the transmission to position **P**.
- ▶ Turn the key to position **0** in the ignition lock and remove it.
- ▶ Secure the vehicle.

The towing eye or trailer tow hitch can be used to pull the vehicle onto a trailer or transporter if you wish to transport it.

Notes for 4MATIC vehicles

! Vehicles with 4MATIC must not be towed with the front or rear axle raised; otherwise, the transmission may be damaged.

Vehicles with 4MATIC may only be either towed away with both axles on the ground or be loaded up and transported.

If the vehicle has transmission damage or damage to the front or rear axle, have it transported on a transporter or trailer.

In the event of damage to the electrical system:

If the battery is defective, the automatic transmission will be locked in position **P**. To shift the automatic transmission to position **N**, you must provide power to the vehicle's on-board electrical system in the same way as when jump-starting (> page 307).

Have the vehicle transported on a transporter or trailer.

Tow-starting (emergency engine starting)

- !** Do not tow-start vehicles with automatic transmission. You could otherwise damage the automatic transmission.
- i** You can find information on "Jump-starting" under (▷ page 307).

Before tow-starting, the following conditions must be fulfilled:

- the battery is connected
- the engine has cooled down
- the exhaust system has cooled down

When tow-starting, it is important that you observe the safety notes (▷ page 309) and the legal requirements in each respective country.

- ▶ Switch on the hazard warning lamps (▷ page 109).
- ▶ Fit the towing eye (▷ page 310).
- ▶ Secure the rigid towing bar or the towing rope.
- ▶ When the vehicle is stationary, depress the brake pedal and keep it depressed.
- ▶ Turn the key to position **2** in the ignition lock (▷ page 135).
- ▶ Depress the clutch pedal fully, engage second gear and continue to keep the clutch pedal fully depressed.
- ▶ Release the brake pedal.
- ▶ Tow-start the vehicle.
- ▶ Release the clutch pedal slowly; do not depress the accelerator pedal while doing so.
- ▶ When the engine has been started, immediately depress the clutch pedal fully and shift to neutral.
- ▶ Pull over at a suitable place and stop the vehicle safely, paying attention to road and traffic conditions.
- ▶ Use the electric parking brake to secure the vehicle and prevent it from rolling away.
- ▶ Remove the rigid towing bar or towing rope.
- ▶ Remove the towing eye (▷ page 311).
- ▶ Switch off the hazard warning lamps.

Fuses

Important safety notes

WARNING

If you manipulate, bridge or replace a faulty fuse with a fuse of a higher amperage, the electric cables could be overloaded. This may result in a fire. There is a risk of an accident and injury.

Always replace faulty fuses with specified new fuses of the correct amperage.

- !** Only use fuses that have been approved for Mercedes-Benz vehicles and which have the correct fuse rating for the system concerned. Only use fuses marked with an "S". Components or systems could otherwise be damaged.
- !** Make sure that no moisture can enter the fuse box when the cover is open.
- !** When closing the cover, make sure that it is lying correctly on the fuse box. Moisture seeping in or dirt could otherwise impair the operation of the fuses.

The fuses in your vehicle disconnect faulty circuits. If a fuse blows, all the components in the circuit and their functions will fail.

Blown fuses must be replaced with fuses of the same rating, which you can recognise by the colour and fuse rating. The fuse ratings are listed in the fuse allocation chart.

The fuse allocation chart is in the fuse box in the front-passenger footwell (▷ page 314).

If the newly inserted fuse also blows, have the cause traced and rectified at a qualified specialist workshop, e.g. a Mercedes-Benz Service Centre.

Before replacing a fuse

- ▶ Secure the vehicle against rolling away (▷ page 157).
- ▶ Switch off all electrical consumers.

► **Vehicles without KEYLESS-GO:** remove the key from the ignition lock.

► **Vehicles with KEYLESS-GO start-function or KEYLESS-GO:** open the driver's door.

The vehicle electronics are now in position . This is the same as “key removed”.

The fuses are located in various fuse boxes:

- Fuse box in the engine compartment on the left-hand side of the vehicle, when viewed in the direction of travel
- Fuse box in the front-passenger footwell

The fuse allocation chart is on the fuse box in the front-passenger footwell (► page 314).



Fuse box in the engine compartment

WARNING

When the bonnet is open, and the windscreen wipers are set in motion, you can be injured by the wiper linkage. There is a risk of injury.

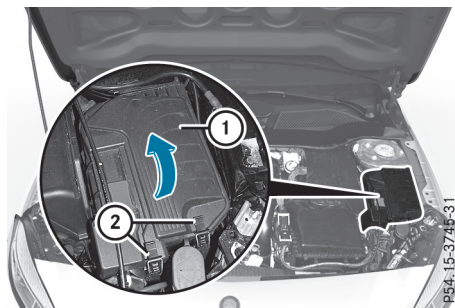

Always switch off the windscreen wipers and the ignition before opening the bonnet.

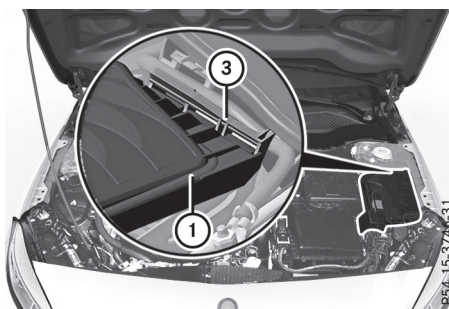

- Open the bonnet.
- Remove any existing moisture from the fuse box using a dry cloth.
- **To open:** open clamps .
- Fold cover  up in the direction of the arrow and remove it.



► **To close:** check whether the seal is lying correctly in cover .

► Insert cover  at the back into openings  on the fuse box.

► Fold down cover .

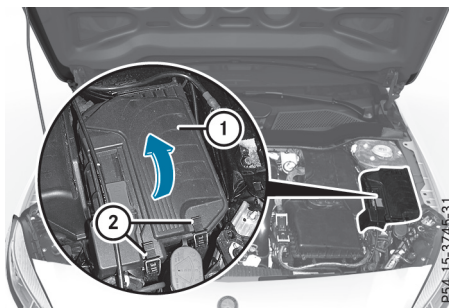

► Hook clamps  into the fuse box and close.

► Close the bonnet.

Fuse box in the front-passenger footwell

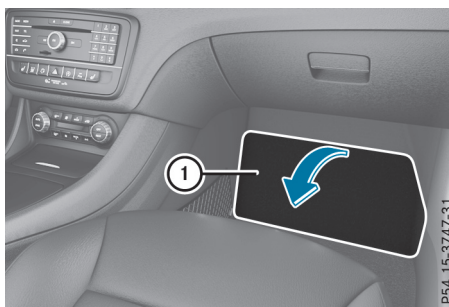

- ▶ **To open:** open the front-passenger door.
- ▶ Remove the floormat.
- ▶ Fold out perforated floor covering ① in the direction of the arrow.

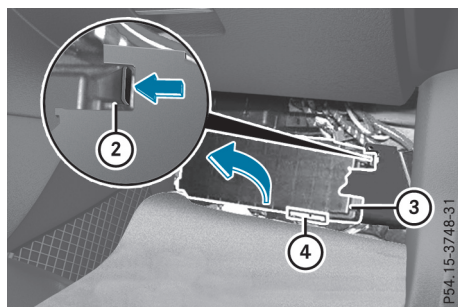

- ▶ To release cover ③, press retaining clamp ②.
- ▶ Fold out cover ③ in the direction of the arrow to the catch.
- ▶ Remove cover ③ forwards.
Fuse allocation chart ④ is located on the lower right-hand side of cover ③.
- ▶ **To close:** insert cover ③ on the left-hand side of the fuse box into the retainer.
Cover ③ engages in the retainers.
- ▶ Fold down cover ③ until clamps ② lock noticeably.
- ▶ Fold back perforated floor covering ①.
- ▶ Fit the floormats.

Important safety notes

WARNING

If wheels and tyres of the wrong size are used, the wheel brakes or suspension components may be damaged. There is a risk of an accident.

Always replace wheels and tyres with those that fulfil the specifications of the original part.

When replacing wheels, make sure to fit the correct:

- designation
- type

When replacing tyres, make sure to fit the correct:

- designation
- manufacturer
- type

WARNING

A flat tyre severely impairs the driving, steering and braking characteristics of the vehicle. There is a risk of accident.

Tyres without run-flat characteristics:

- do not drive with a flat tyre.
- immediately replace the flat tyre with your emergency spare wheel or spare wheel, or consult a qualified specialist workshop.

Tyres with run-flat characteristics:

- pay attention to the information and warning notices on MOExtended tyres (tyres with run-flat characteristics).

Accessories that are not approved for your vehicle by Mercedes-Benz or are not being used correctly can impair operating safety.

Before purchasing and using non-approved accessories, visit a qualified specialist workshop and enquire about:

- suitability
- legal stipulations
- factory recommendations

Further information regarding wheels and tyres can be found under "Wheel/tyre combinations" (▷ page 329).

You can ask for information regarding permitted wheel/tyre combinations at a Mercedes-Benz Service Centre.

Information on tyre pressures can be found:

- on the tyre pressure table in the fuel filler flap (▷ page 155)
- under "Tyre pressure" (▷ page 319)

Modification work on the brake system and wheels is not permitted. The use of spacers or brake dust shields is not permitted. This invalidates the general operating permit for the vehicle.

 Further information on wheels and tyres can be obtained at any qualified specialist workshop.

Operation

Information on driving

Check the tyre pressure when the vehicle is heavily laden and adjust prior to a trip.

While driving, pay attention to vibrations, noises and unusual handling characteristics, e.g. pulling to one side. This may indicate that the wheels or tyres are damaged. If you suspect that a tyre is defective, reduce your speed immediately. Stop the vehicle as soon as possible to check the wheels and tyres for damage. Hidden tyre damage could also be causing the unusual handling characteristics. If you find no signs of damage, have the tyres and wheels checked at a qualified specialist workshop.

When parking your vehicle, make sure not to squash the tyre. If you cannot avoid driving over obstacles, e.g. kerbs, do so slowly and at an obtuse angle only. You could otherwise damage the wheel rims and tyres.

Regular checking of wheels and tyres

WARNING

Damaged tyres can cause tyre inflation pressure loss. As a result, you could lose control of your vehicle. There is a risk of accident.

Check the tyres regularly for signs of damage and replace any damaged tyres immediately.

Check wheels and tyres for damage at least once a month. Check wheels and tyres after driving off-road or on rough roads. Damaged wheels can cause a loss of tyre pressure. Pay particular attention to damage such as:

- cuts in the tyres
- punctures
- tears in the tyres
- bulges on the tyres
- deformation or severe corrosion on the wheels

Regularly check the tyre tread depth and the condition of the tread across the whole width of the tyre (▷ page 317). If necessary, turn the front wheels to full lock to make it easier to inspect the inner side of the tyre surface.

All wheels must have a valve cap to protect the valve against dirt and moisture. Do not fit anything onto the valve other than the standard valve cap or other valve caps specially approved for your vehicle by Mercedes-Benz. Do not fit any other valve caps or systems, e.g. tyre pressure monitors.

Check the pressure of all tyres regularly as well as prior to long trips. Adjust the tyre pressures as necessary (▷ page 319).

Observe the notes on the emergency spare wheel (▷ page 330).

The service life of a tyre depends on various factors, including the following:

- driving style
- tyre pressure
- mileage

Notes on the tyre tread

WARNING

Insufficient tyre tread will reduce tyre traction. The tyre is no longer able to dissipate water. This means that on wet road surfaces, the risk of aquaplaning increases, in particular where speed is not adapted to suit the driving conditions. There is a risk of accident.

If the tyre pressure is too high or too low, tyres may exhibit different levels of wear at differ-

ent locations on the tyre tread. Thus, you should regularly check the tread depth and the condition of the tread across the entire width of all tyres.

Minimum tyre tread depth for:

- summer tyres: 3 mm
- M+S tyres: 4 mm

For safety reasons, replace the tyres before the legally prescribed limit for the minimum tyre tread depth is reached.

Selecting, fitting and replacing tyres

WARNING

Exceeding the stated tyre load-bearing capacity and the approved maximum speed could lead to tyre damage or the tyre bursting. There is a risk of accident.

Therefore, only use tyre types and sizes approved for your vehicle model. Observe the tyre load rating and speed rating required for your vehicle.

Pay special attention to country-specific requirements for tyre approval. These requirements may stipulate a specific tyre type for your vehicle. Furthermore, the use of a specific tyre type in certain regions and areas of operation can be highly beneficial. You can find further information regarding tyres at specialist tyre retailers, at qualified specialist workshops or at any Mercedes-Benz Service Centre.

- Use only tyres and wheels of the same type and make.

Exception: it is permissible to fit a different type or make in the event of a flat tyre. Observe here the "MOExtended tyres (tyres with run-flat characteristics)" section (▷ page 300).

- Fit only tyres of the correct size onto the wheels.
- Run in new tyres at moderate speeds for the first 100 km. They reach their full performance only after this distance.

- Do not drive with tyres that have too little tread depth. This significantly reduces traction on wet roads (aquaplaning).
- Replace the tyres after six years at the latest, regardless of wear.

Observe the notes on the emergency spare wheel (▷ page 330).

MOExtended tyres (tyres with run-flat characteristics)

With MOExtended tyres (tyres with run-flat characteristics), you can continue to drive your vehicle even if there is a total loss of pressure in one or more tyres.

MOExtended tyres may be used only in conjunction with an activated tyre pressure loss warning system or with an activated tyre pressure monitor and only on wheels specifically tested by Mercedes-Benz.

Notes on driving with MOExtended tyres with a flat tyre (▷ page 300).

Vehicles with MOExtended tyres are not equipped with a TIREFIT kit at the factory. It is therefore recommended that you additionally equip your vehicle with a TIREFIT kit if you fit tyres that do not feature run-flat characteristics, e.g. winter tyres. A TIREFIT kit can be obtained from a qualified specialist workshop.

Winter operation

General notes

Have your vehicle winterproofed at a qualified specialist workshop at the onset of winter.

Observe the notes in the "Changing a wheel" section (▷ page 324).

Driving with summer tyres

At temperatures below +7 °C, summer tyres lose elasticity and therefore traction and braking power. Change the tyres on your vehicle to M+S tyres. Using summer tyres at very cold temperatures could cause tears to form, thereby damaging the tyres permanently. Mercedes-Benz cannot accept responsibility for this type of damage.

WARNING

Damaged tyres can cause tyre inflation pressure loss. As a result, you could lose control of your vehicle. There is a risk of accident.

Check the tyres regularly for signs of damage and replace any damaged tyres immediately.

M+S tyres

WARNING

M+S tyres with a tyre tread depth of less than 4 mm are not suitable for use in winter as they do not provide sufficient traction. There is a risk of accident.

M+S tyres with a tread depth of less than 4 mm must be replaced.

At temperatures below +7 °C, use winter tyres or all-season tyres. Both types of tyre are identified by the M+S marking.

Only winter tyres bearing the  snowflake symbol in addition to the M+S marking provide the best possible grip in wintry road conditions. Only these tyres will allow driving safety systems such as ABS and ESP® to function optimally in winter. These tyres have been developed specifically for driving in snow.

Use M+S tyres of the same make and tread on all wheels to maintain safe handling characteristics.

Always observe the maximum permissible speed specified for the M+S tyres you have fitted.

If you fit M+S tyres that have a lower maximum permissible speed than that of the vehicle, affix an appropriate warning label in the driver's field of vision. This can be obtained at a qualified specialist workshop.

Under these circumstances, you should also restrict the maximum design speed of the vehicle using the permanent limiter to the maximum permissible speed for the M+S tyres (▷ page 168).

When you have fitted the M+S tyres:

- ▶ Check the tyre pressures (▷ page 319).
- ▶ Restart the tyre pressure loss warning system (▷ page 321).
- ▶ Restart the tyre pressure monitor (▷ page 323).

Information about driving with an emergency spare wheel (▷ page 330).

Snow chains

WARNING

If snow chains are fitted to the rear wheels, they may scrape against the vehicle body or chassis components. This could cause damage to the vehicle or the tyres. There is a risk of an accident.

To avoid hazardous situations:

- never fit snow chains on the rear wheels
- always fit snow chains in pairs to the front wheels.

! **Vehicles with steel wheels:** if you fit snow chains on steel wheels, you may damage the hub caps. Remove the hub caps from the relevant wheels before fitting the snow chains.

For safety reasons, Mercedes-Benz recommends that you use only snow chains that have been approved for Mercedes-Benz or that are of an equivalent standard of quality. For more information, please contact a qualified specialist workshop.

If you wish to fit snow chains, please bear the following points in mind:

- snow chains cannot be fitted to all wheel/tyre combinations. Permissible wheel-tyre combinations (▷ page 329).
- use snow chains only if the road surface is completely snow-covered. Remove the snow chains as soon as possible when you come to a road that is not snow-covered.
- local regulations may restrict the use of snow chains. Observe the appropriate regulations if you wish to fit snow chains.
- do not exceed the maximum permissible speed of 50 km/h.
- never use Parking Pilot when snow chains are fitted (▷ page 183).

You may wish to deactivate ESP® when pulling away with snow chains fitted. This allows the wheels to spin in a controlled manner, achieving increased propulsive force (cut).

- Deactivate ESP® (all vehicles except Mercedes-AMG vehicles) (▷ page 70)
- Deactivate ESP® (Mercedes-AMG vehicles) (▷ page 71)

Information about driving with an emergency spare wheel (▷ page 330).

Tyre pressure

Tyre pressure specifications

WARNING

Underinflated or overinflated tyres pose the following risks:

- the tyres may burst, especially as the load and vehicle speed increase.
- the tyres may wear excessively and/or unevenly, which may greatly impair tyre traction.
- the driving characteristics, as well as steering and braking, may be greatly impaired.

There is a risk of an accident.

Observe the recommended tyre pressure and check the tyre pressure of all the tyres including the spare wheel:

- at least every two weeks
- when the load changes
- before embarking on a longer journey
- for changed operating conditions, e.g. off-road driving

If necessary, correct the tyre pressure.

WARNING

If you fit unsuitable accessories onto tyre valves, the tyre valves may be overloaded and malfunction, which can cause tyre pressure loss. Due to their design, retrofitted tyre pressure monitors keep the tyre valve open. This can also result in tyre pressure loss. There is a risk of accident.

Only screw standard valve caps or valve caps specifically provided by Mercedes-Benz for your vehicle onto the tyre valve.

⚠ WARNING

If the tyre pressure drops repeatedly, the wheel, valve or tyre may be damaged. Tyre pressure that is too low may result in a tyre blow-out. There is a risk of accident.

- Check the tyre for foreign objects.
- Check whether the wheel is losing air or the valve is leaking.

If you are unable to rectify the damage, contact a qualified specialist workshop.

🌀 Environmental note

Check the tyre pressure regularly, at least every 14 days.

The recommended tyre pressures for various operating conditions can be found on the tyre pressure table on the fuel filler flap (▷ page 155).

Operation with an emergency spare wheel: information on operation with an emergency spare wheel can be found in the general notes in the "Emergency spare wheel" section (▷ page 330).

Operation with a trailer: the applicable value for the rear axle is the maximum value stated in the tyre pressure table inside the fuel filler flap. Additionally, the tyre pressure table may also state tyre pressures for different load conditions. These are defined in the table as different numbers of passengers and amounts of luggage. The actual number of seats may vary; for more information, please refer to the vehicle documents.

If tyre sizes are not specified, the tyre pressures stated on the tyre pressure table apply for all tyres approved at the factory for this vehicle.

		kPa		psi	
Lufldruck für kalte Reifen Tire pressure cold tires Pression des pneus froids Presión neumáticos fríos Hava basıncı: soğuk lastik için					
255/40 R18 285/35 R18					
255/35 R19 285/30 R19					
Warme Reifen bis: Warm tires up to: Pneus încălzite până la:		Neumáticos calientes hasta: Soğuk lastiklere en fazla:		+ 30 kPa	+ 4 psi
Winterreifen: Winter tires: Pneus iervet:		Neumáticos de invierno: Kışık lastikler:		+ 30 kPa	+ 4 psi

A 231 564 03 07
P40.00-2261-31

If a tyre size precedes a tyre pressure, the following tyre pressure information is valid only for that tyre size.

Use a suitable pressure gauge to check the tyre pressure. The outer appearance of a tyre does not give any reliable indication of the tyre pressure. On vehicles fitted with the electronic tyre pressure monitor, you can also check the tyre pressure using the on-board computer.

If possible, correct tyre pressures only when the tyres are cold.

The tyres are cold:

- if the vehicle has been parked with the tyres out of direct sunlight for at least three hours and
- if the vehicle has been driven less than 1.6 km

Depending on the ambient temperature, the vehicle speed and the load on the tyres, the tyre temperature and thus the tyre pressure changes by approximately 10 kPa (0.1 bar/1.5 psi) per 10 °C. Take this into account when checking the pressure of warm tyres. Correct the tyre pressure only if it is too low for the current operating condition.

Driving with a tyre pressure that is too high or too low can:

- shorten the service life of the tyres
- cause increased tyre damage
- have a negative effect on handling characteristics and thus driving safety (e.g. aquaplaning)

The tyre pressure values given for low loads are minimum values that offer you good driving comfort characteristics.

However, you can also use the values given for higher loads. These are permissible and will not adversely affect the running of the vehicle.

Tyre pressure loss warning system

General notes

While the vehicle is in motion, the tyre pressure loss warning system monitors the set tyre pressure using the rotational speed of the wheels. This enables the system to detect significant pressure loss in a tyre. If the rotational speed of a wheel changes as a result of a loss of tyre pressure, a corresponding warning message will appear on the multifunction display.

You can recognise the tyre pressure loss warning by the **Run Flat Indicator active Restart with OK** message that appears on the multifunction display in the **Serv.** menu. Information on the message display can be found in the "Restarting the tyre pressure loss warning system" section (▷ page 321).

Important safety notes

The tyre pressure warning system does not warn you of an incorrectly set tyre pressure. Observe the notes on the recommended tyre pressure (▷ page 319).

The tyre pressure loss warning system does not replace the need to check the tyre pressure regularly. An even loss of pressure on several tyres at the same time cannot be detected by the tyre pressure loss warning system.

The tyre pressure loss warning system is not able to warn you of a sudden loss of air, e.g. if the tyre is penetrated by a foreign object. In this event, bring the vehicle to a halt by braking carefully. Avoid abrupt steering manoeuvres.

The function of the tyre pressure loss warning system is limited or delayed if:

- snow chains are fitted on your vehicle
- road conditions are wintry
- you are driving on a loose surface (e.g. sand or gravel)
- you adopt a very sporty driving style (cornering at high speeds or driving with high rates of acceleration)
- you are towing a very heavy or large trailer
- you are driving with a heavy load (in the vehicle or on the roof)

Restarting the tyre pressure loss warning system

Restart the tyre pressure loss warning system if you have:

- changed the tyre pressure
 - changed the wheels or tyres
 - fitted new wheels or tyres
- Before restarting, make sure that the tyre pressures are set properly on all four tyres for the respective operating conditions. The recommended tyre pressures can be found on the tyre pressure table on the fuel filler flap.
- The tyre pressure loss warning system can give reliable warnings only if you have set the correct tyre pressure. If an incorrect tyre pressure is set, this incorrect value will be monitored.
- Observe the notes in the section on tyre pressures (▷ page 319).
- Make sure that the key is in position **2** in the ignition lock (▷ page 135).
- Press **◀** or **▶** on the steering wheel to select the **Serv.** menu.
- Press the **▲** or **▼** button to select **Tyre pressure**.
- Press the **OK** button.
The **Run Flat Indicator active Restart with OK** message appears on the multifunction display.

If you wish to confirm the restart:

- Press the **OK** button.
The **Tyre press. now OK?** message appears on the multifunction display.
- Press the **▲** or **▼** button to select **Yes**.
- Press the **OK** button.
The **Run Flat Indicator restarted** message appears on the multifunction display.
- After a teach-in period, the tyre pressure loss warning system will monitor the set tyre pressures of all four tyres.

If you wish to cancel the restart:

- Press the **↩** button.
- or
- If the **Tyre press. now OK?** message appears, press the **▲** or **▼** button to select **Cancel**.
- Press the **OK** button.
The tyre pressure values stored at the last restart will continue to be monitored.

Tyre pressure monitor

General notes

If a tyre pressure monitor is fitted, the vehicle's wheels have sensors fitted that monitor the tyre pressures in all four tyres. The tyre pressure monitor warns you if the pressure drops in one or more of the tyres. The tyre pressure monitor functions only if the corresponding sensors are fitted to all wheels.

Information on tyre pressures is shown on the multifunction display. After a few minutes of driving, the current tyre pressure of each tyre is shown in the **Serv.** menu of the multifunction display, see illustration (example).



Information on the message display can be found in the "Checking the tyre pressure electronically" section (▷ page 322).

Important safety notes

It is the driver's responsibility to set the tyre pressure to the recommended cold tyre pressure suitable for the operating situation (▷ page 319). Note that the correct tyre pressure for the current operating situation must first be learnt by the tyre pressure monitor. If a substantial loss of pressure occurs, the warning threshold for the warning message is aligned to the learnt reference values. Restart the tyre pressure monitor after adjusting to the cold tyre pressure (▷ page 323). The current pressures are saved as new reference values. This ensures that a warning message appears only if the tyre pressure drops significantly.

The tyre pressure monitor does not warn you of an incorrectly set tyre pressure. Observe the notes on the recommended tyre pressure (▷ page 319).

The tyre pressure monitor is not able to warn you of a sudden loss of pressure, e.g. if the tyre is penetrated by a foreign object. In this event, bring the vehicle to a halt by braking carefully. Avoid abrupt steering manoeuvres.

The tyre pressure monitor has a yellow warning lamp on the instrument cluster for indicating a pressure loss or malfunction. Depending on how the warning lamp flashes or lights up, a tyre pressure that is too low or a malfunction in the tyre pressure monitor is indicated:

- if the warning lamp is lit continuously, the tyre pressure on one or more tyres is significantly too low. The tyre pressure monitor is not malfunctioning.
- if the warning lamp flashes for approximately one minute and then remains lit constantly, the tyre pressure monitor is malfunctioning.

In addition to the warning lamp, a message appears on the multifunction display. Observe the information on display messages (▷ page 240).

It may take up to ten minutes for a malfunction of the tyre pressure monitor to be indicated. A malfunction will be indicated by the tyre pressure warning lamp flashing for approximately one minute and then remaining lit. When the fault has been rectified, the tyre pressure warning lamp goes out after you have driven for a few minutes.

The tyre pressure values indicated by the on-board computer may differ from those measured at a filling station using a pressure gauge. The tyre pressures shown by the on-board computer refer to those measured at sea level. At high altitudes, the tyre pressure values indicated by a pressure gauge are higher than those shown by the on-board computer. In this case, do not reduce the tyre pressures.

The operation of the tyre pressure monitor can be affected by interference from radio transmitting equipment (e.g. cordless headphones, two-way radios) that may be being operated in or near the vehicle.

Checking the tyre pressure electronically

- ▶ Make sure that the key is in position **2** in the ignition lock (▷ page 135).
- ▶ Press **◀** or **▶** on the steering wheel to select the **Serv.** menu.
- ▶ Press the **▲** or **▼** button to select **Tyre pressure**.
- ▶ Press the **OK** button.
The current tyre pressure for each wheel will be displayed on the multifunction display.

If the vehicle was parked for longer than 20 minutes, the **Tyre pressures will be displayed after a few minutes of driving** message is shown.

After a teach-in period, the tyre pressure monitor automatically detects new wheels or new sensors. As long as a clear allocation of the tyre pressure values to the individual wheels is not possible, the **Tyre pressure monitor active** message is shown instead of the tyre pressure display. The tyre pressures are already being monitored.

After an emergency spare wheel has been fitted, the system may still display the tyre pressure of the removed wheel for a few minutes. If this occurs, note that the value displayed for the position where the spare wheel is fitted is not the same as the current tyre pressure of the emergency spare wheel.

Warning messages of the tyre pressure monitor

If the tyre pressure monitor detects a pressure loss in one or more tyres, a warning message is shown on the multifunction display. The yellow tyre pressure warning lamp then lights up:

- If the **Please correct tyre pressure** message appears in the multifunction display, the tyre pressure in at least one tyre is too low. The tyre pressure must be corrected when the opportunity arises.
- If the **Tyre pressure Check tyre(s)** message appears in the multifunction display, the tyre pressure in one or more tyres has dropped significantly. The tyres must be checked.
- If the **Tyre pressure Caution Tyre malfunction** message appears in the multifunction display, the tyre pressure in one or more tyres has dropped suddenly. The tyres must be checked.

Observe the instructions and safety notes in the display messages in the "Tyres" section (▷ page 240).





If the position of the wheels on the vehicle is changed, the tyre pressures may be displayed in the wrong positions for a short time. After a few minutes of driving, this is rectified and the tyre pressures are displayed in the correct positions.

Restarting the tyre pressure monitor

When you restart the tyre pressure monitor, all existing warning messages are deleted and the warning lamps go out. The monitor uses the currently set tyre pressures as the reference values for monitoring. In most cases, the tyre pressure monitor will automatically detect the new reference values after you have changed the tyre pressure. However, you can also set reference values manually as described here. The tyre pressure monitor then monitors the new tyre pressure values.

- ▶ Use the table on the inside of the fuel filler flap to ensure that the tyre pressure is set correctly in all four tyres for the current operating conditions.

Also observe the notes in the section on tyre pressures (▷ page 319).

- ▶ Make sure that the key is in position **2** in the ignition lock (▷ page 135).
- ▶ Press  or  on the steering wheel to select the **Serv.** menu.
- ▶ Press the  or  button to select **Tyre pressure**.
- ▶ Press the **OK** button.
The multifunction display shows the current tyre pressure for each tyre or the **Tyre pressures will be displayed after a few minutes of driving** message.
- ▶ Press the  button.
The multifunction display shows the **Use current pressures as new reference values** message.

If you wish to confirm the restart:

- ▶ Press the **OK** button.
The **Tyre press. monitor restarted** message appears in the multifunction display.
After you have been driving for a few minutes, the system checks whether the current tyre pressures are within the specified range. The new tyre pressures are then accepted as reference values and monitored.

If you wish to cancel the restart:

- ▶ Press the  button.
The tyre pressure values stored at the last restart will continue to be monitored.

Radio type approval for the tyre pressure monitor

Country	Radio type approval number
Argentina	Schrader GG4 Numero de Registro CNC: H-12338
Brazil	 <p style="text-align: right; font-size: small;">P99.00-3862-00</p> <p>Este equipamento opera em carater secundario, isto e, nao tem direito a protecao contra interferencia prejudicial, mesmo de estacoes do tipo, e nao pode causar interferencia a sistemas operando em carater primario.</p>
Abu Dhabi Dubai	TRA REGISTERED NO: ER0099792/12. DEALER NO: DA0047074/10
European Union	Schrader Electronics Ltd 11 Technology Park, Belfast Road, Antrim BT4 1 1QS, Northern Ireland
Jordan	Kingdom of Jordan Type approval for Tyre Pressure sensor. Manufacturer: Schrader Electronics Ltd. Model: GG4 Type Approval Number: TRC/LPD/2012/190 Model: MC34MA4 Type Approval Number: TRC/LPD/2011/158
Morocco	AGREE PAR L'ANRT MAROC Numero d'agrement: MR 10216 ANRT 2012 Date d'agrement: 23/11/2012
Moldova	

Country	Radio type approval number
Philippines	 NTC Type Approved. No: ESD-1306871C
Serbia	 I 011 12
Singapore	Complies with IDA Standards DA 103365
South Africa	 TA-2012/1540 Approved TA-2011/1370 Approved

Changing a wheel

Flat tyre

You can find information on what to do in the event of a flat tyre in the "Breakdown assistance" section ([▷](#) page 299). Information on driving with MOExtended tyres in the event of a flat tyre can be found under "Breakdown assistance" ([▷](#) page 300).

Vehicles with an emergency spare wheel: in the event of a flat tyre, the emergency spare wheel is fitted according to the description under "Fitting a wheel" ([▷](#) page 325).

Vehicles with Mercedes-Benz emergency call system: in the event of a flat tyre, you can contact the Customer Assistance Centre for the Mercedes-Benz emergency call system ([▷](#) page 325).

Changing the wheels

WARNING

Interchanging the front and rear wheels may severely impair the driving characteristics if

the wheels or tyres have different dimensions. The wheel brakes or suspension components may also be damaged. There is a risk of accident.

Interchange front and rear wheels only if the wheels and tyres are of the same dimensions.

! On vehicles fitted with a tyre pressure monitor, electronic components are located in the wheel.

Tyre-fitting tools should not be applied in the area of the valve, as this could damage the electronic components.

Only have tyres changed at a qualified specialist workshop.

Interchanging the front and rear wheels of differing dimensions can render the general operating permit invalid.

Observe the instructions and safety notes in the "Changing a wheel" section (▷ page 324).

The wear patterns on the front and rear tyres differ depending on the operating conditions. Interchange the wheels before a clear wear pattern has formed on the tyres. Front tyres typically wear more on the shoulders, while rear tyres wear more in the centre.

On vehicles that have front and rear wheels of the same size, you can interchange the wheels every 5,000 to 10,000 km depending on the degree of tyre wear. Ensure the direction of rotation is maintained.

Clean the contact surfaces of the wheel and the brake disc thoroughly every time a wheel is interchanged. Check the tyre pressure and, if necessary, restart the tyre pressure loss warning system or the tyre pressure monitor.

Direction of rotation

Tyres with a specified direction of rotation have additional benefits, e.g. if there is a risk of aquaplaning. These advantages can only be gained if the tyres are fitted corresponding to the direction of rotation.

An arrow on the sidewall of the tyre indicates its correct direction of rotation.

Mounting wheels

Store wheels in a cool, dry and preferably dark place if they are not being used. Protect the tyres against oil, grease, petrol and diesel.

Fitting a wheel

Preparing the vehicle

- ▶ Stop the vehicle on solid, non-slippery and level ground.
- ▶ Apply the electric parking brake manually.
- ▶ Move the front wheels to the straight-ahead position.
- ▶ **Vehicles with manual transmission:** fully depress the clutch pedal and engage first or reverse gear.
- ▶ **Vehicles with automatic transmission:** shift the transmission to position **P**.
- ▶ Switch off the engine.
- ▶ **Vehicles without KEYLESS-GO:** remove the key from the ignition lock.
- ▶ **Vehicles with KEYLESS-GO start-function or KEYLESS-GO:** open the driver's door. The vehicle electronics are now in position **0**. This is the same as "key removed".
- ▶ **Vehicles with KEYLESS-GO start function or KEYLESS-GO:** remove the Start/Stop button from the ignition lock (▷ page 135).
- ▶ If included in the vehicle equipment, remove the tyre-change tool kit from the vehicle.
- ▶ Additionally secure the vehicle against rolling away (▷ page 157).

i Apart from some country-specific variants, vehicles are not equipped with a tyre-change tool kit. Some tools for changing a wheel are specific to the vehicle. For more information on which tools are required to perform a wheel change on your vehicle, consult a qualified specialist workshop.

Necessary tyre-changing tools may include, for example:

- Jack
- Wheel chock
- Wheel wrench

Securing the vehicle against rolling away

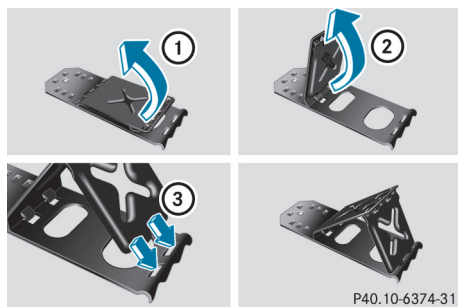

If your vehicle is equipped with a wheel chock, it can be found in the tyre-change tool kit (▷ page 299).

The folding wheel chock is an additional securing measure to secure the vehicle against rolling away, e.g. when changing a wheel.

- ▶ Fold both plates upwards ①.
- ▶ Fold out lower plate ②.
- ▶ Insert the lugs on the lower plate fully into the openings in base plate ③.



- ▶ Place chocks or other suitable items under the front and rear of the wheel that is diagonally opposite the wheel you wish to change.

Raising the vehicle

WARNING

If you do not position the jack correctly at the appropriate jacking point of the vehicle, the jack could tip over with the vehicle raised. There is a risk of injury.

Only position the jack at the appropriate jacking point of the vehicle. The base of the jack

must be positioned vertically, directly under the jacking point of the vehicle.

Observe the following when raising the vehicle:

- Use only the vehicle-specific jack that has been tested and approved by Mercedes-Benz to raise the vehicle. If the jack is used incorrectly, it could tip over while the vehicle is raised.
- The jack is designed only to raise the vehicle for a short time while a wheel is being changed. It is not permissible to use it to perform maintenance work under the vehicle.
- Avoid changing the wheel on uphill and downhill slopes.
- Before raising the vehicle, secure it against rolling away by applying the parking brake and positioning wheel chocks. Do not release the parking brake while the vehicle is raised.
- The jack must be placed on a firm, flat and non-slip surface. On a loose surface, a large, flat load-bearing underlay must be used. On a slippery surface, a non-slip underlay must be used, e.g. use a rubber mat on tiles.
- Do not use wooden blocks or similar objects as a jack underlay. Otherwise, the jack will not be able to achieve its load-bearing capacity due to the restricted height.
- Ensure that the distance between the underside of the tyre and the ground does not exceed 3 cm.
- Never place your hands or feet under the raised vehicle.
- Do not lie under the raised vehicle.
- Do not start the engine when the vehicle is raised.
- Do not open or close a door or the tailgate when the vehicle is raised.
- Ensure that no persons are present in the vehicle when raising the vehicle.

Vehicles with steel wheels: the hub cap covers the wheel bolts. Before you can unscrew the wheel bolts, you must remove the wheel trim.

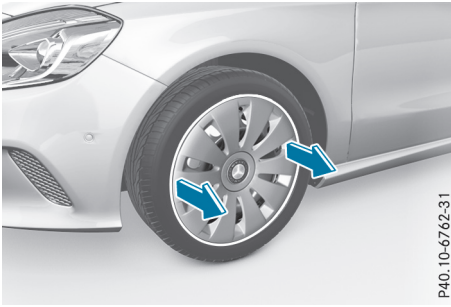

P40.10-6762-31

- ▶ Using both hands, carefully reach into two wheel trim openings and remove the wheel trim.

Vehicles with hub caps: the hub cap covers the wheel bolts. Before you can unscrew the wheel bolts, you must remove the hub cap.



P40.10-6769-31

- ▶ **To remove:** turn the centre cover of hub cap ① anti-clockwise and remove.
- ▶ **To fit:** before fitting, ensure that hub cap ① is in the open position. To do this, turn the centre cover anti-clockwise.
- ▶ Position hub cap ① and turn the centre cover clockwise until hub cap ① engages physically and audibly.
- ▶ Make sure that hub cap ① is fitted securely.

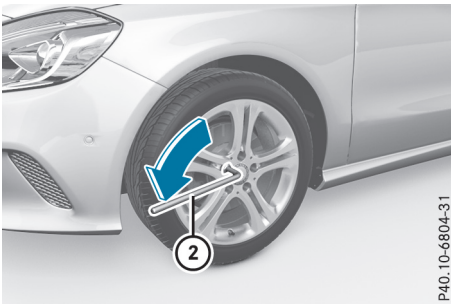

P40.10-6804-31

- ▶ Using wheel wrench ②, loosen the bolts on the wheel you wish to change by about one full turn. Do not unscrew the bolts completely.

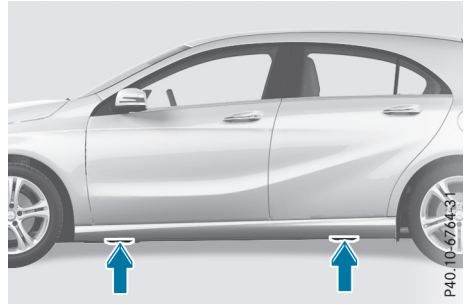

P40.10-6764-31

Jacking points

The jacking points are located just behind the front wheel arches and just in front of the rear wheel arches (arrows).

Mercedes-AMG vehicles and vehicles with AMG Line: to protect the vehicle body, the vehicle has covers fitted next to the jacking points on the outer sills.



P40.10-6805-31

Cover, front (example: vehicles with AMG Line)

- ▶ **Mercedes-AMG vehicles and vehicles with AMG Line:** fold cover ③ upwards.

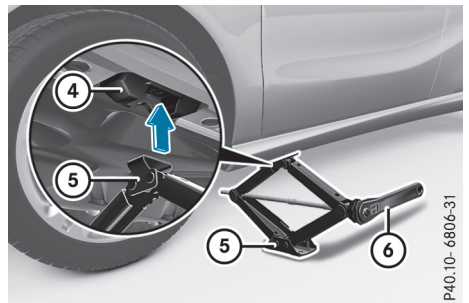

P40.10-6806-31

- ▶ Take ratchet ring spanner ⑥ out of the vehicle tool kit and place it on the hexagon nut of jack ⑤ so that the letters **AUF** are visible.
- ▶ Position jack ⑤ at jacking point ④.

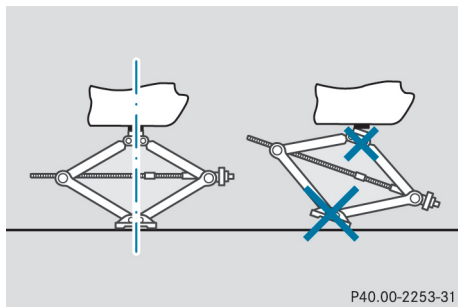

- ▶ Ensure that the base of the jack is positioned vertically under the jacking point.
- ▶ Turn ratchet ring spanner ⑥ until jack ⑤ sits completely on jacking point ④ and the base of the jack lies evenly on the ground.
- ▶ Turn ratchet ring spanner ⑥ until the tyre is raised a maximum of 3 cm from the ground.

Removing a wheel

- ⚠ Do not place wheel bolts in sand or dirt. The threads of the wheel bolts and wheel hubs could otherwise be damaged when the bolts are tightened.
- ▶ Unscrew the wheel bolts.
- ▶ Remove the wheel.

Fitting a new wheel

⚠ WARNING

Oiled or greased wheel bolts or damaged wheel bolts/hub threads can cause the wheel bolts to come loose. As a result, you could lose a wheel while driving. There is a risk of accident.

Never oil or grease wheel bolts. In the event of damage to the threads, contact a qualified specialist workshop immediately. Have the damaged wheel bolts or hub threads replaced/renewed. Do not continue driving.

⚠ WARNING

If you tighten the wheel bolts or wheel nuts when the vehicle is raised, the jack could tip over. There is a risk of injury.

Only tighten the wheel bolts or wheel nuts when the vehicle is on the ground.

It is imperative to observe the instructions and safety notes on "Changing a wheel" (▷ page 324).

Use only wheel bolts that have been designed for the wheel and the vehicle. For safety reasons, Mercedes-Benz recommends that you use only wheel bolts that have been approved for Mercedes-Benz vehicles and the respective wheel.



- ▶ Clean the wheel and wheel hub contact surfaces.
- ▶ Place the new wheel on the wheel hub and push it on.
- ▶ Tighten the wheel bolts until they are finger-tight.

Lowering the vehicle

⚠ WARNING

The wheels could work loose if the wheel nuts and bolts are not tightened to the specified tightening torque. There is a risk of accident.

Have the tightening torque immediately checked at a qualified specialist workshop after a wheel is changed.

- ▶ Place the ratchet ring spanner onto the hexagon nut of the jack so that the letters **AB** are visible.
- ▶ Turn the ratchet ring spanner until the vehicle is once again standing firmly on the ground.
- ▶ Place the jack to one side.

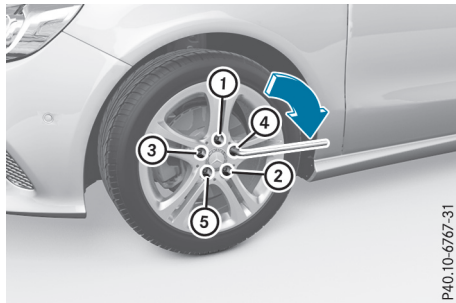

- ▶ Tighten the wheel bolts evenly in a crosswise pattern in the sequence indicated (① to ⑤). The tightening torque must be **130 Nm**.
- ▶ Turn the jack back to its initial position.
- ▶ Stow the jack and the rest of the vehicle tools in the vehicle again.
- ▶ **Mercedes-AMG vehicles and vehicles with AMG Line:** use the cover of the outer sill.
- ▶ Check the tyre pressure of the newly fitted wheel and adjust if necessary. Observe the recommended tyre pressures (▷ page 319).

If you are driving with the emergency spare wheel fitted, the tyre pressure loss warning system or the tyre pressure monitor cannot function reliably. Restart the tyre pressure loss warning system or tyre pressure monitor only once the defective wheel has been replaced with a new wheel.

Vehicles with tyre pressure monitor: all fitted wheels must be equipped with functioning sensors.

Wheel/tyre combinations

General notes

You can ask for information regarding permitted wheel/tyre combinations at a Mercedes-Benz Service Centre.

You should regularly check the pressure of all your tyres, including the emergency spare wheel, particularly prior to long trips, and cor-

rect the pressure as necessary (▷ page 319). The value on the wheel is valid.

! For safety reasons, Mercedes-Benz recommends that you only use tyres and wheels which have been approved by Mercedes-Benz specifically for your vehicle.

These are specially adapted to the control systems, such as ABS or ESP® and are marked as follows:

- MO = Mercedes-Benz Original
- MOE = Mercedes-Benz Original Extended (tyres featuring run-flat characteristics)
- MO1 = Mercedes-Benz Original (only certain AMG tyres)

Mercedes-Benz Original Extended tyres may only be used on wheels that have been specifically approved by Mercedes-Benz.

Only use tyres, wheels or accessories tested and approved by Mercedes-Benz. Certain characteristics, e.g. handling, vehicle noise emissions or fuel consumption, may otherwise be adversely affected. In addition, when driving with a load, tyre dimension variations could cause the tyres to come into contact with the bodywork and axle components. This could result in damage to the tyres or the vehicle.

Mercedes-Benz accepts no liability for damage resulting from the use of tyres, wheels or accessories other than those tested and approved.

Further information about wheels, tyres and approved combinations can be obtained from any qualified specialist workshop.

! Retreaded tyres are neither tested nor recommended by Mercedes-Benz, since previous damage cannot always be detected on retreaded tyres. As a result, Mercedes-Benz cannot guarantee vehicle safety if retreaded tyres are fitted. Do not fit used tyres if you have no information about their previous usage.

! Large wheels: the lower the section width for a certain wheel size, the lower the ride comfort is on poor road surfaces. Roll comfort and suspension comfort are reduced and the risk of damage to the wheels and tyres as a result of driving over obstacles increases.

The recommended tyre pressures for various operating conditions can be found on the tyre pressure table on the fuel filler flap. Further

information on tyre pressure (▷ page 319). Check tyre pressures regularly and only when the tyres are cold.

Notes on the vehicle equipment – always fit the vehicle:

- with tyres of the same size across an axle (left/right)
- with the same type of tyre (summer tyres, MOExtended tyres, winter tyres)
Exception: it is permissible to fit a different type or make in the event of a flat tyre. Observe the "MOExtended tyres (tyres with run-flat characteristics)" section (▷ page 300).

Vehicles with MOExtended tyres are not equipped with a TIREFIT kit at the factory. It is therefore recommended that you additionally equip your vehicle with a TIREFIT kit if you fit tyres that do not feature run-flat characteristics, e.g. winter tyres. A TIREFIT kit can be obtained from a qualified specialist workshop.

Emergency spare wheel

Important safety notes

WARNING

The wheel/tyre dimensions and the tyre type of the spare wheel/emergency spare wheel and the wheel to be replaced may differ. Fitting a spare wheel/emergency spare wheel may severely impair the driving characteristics. There is a risk of accident.

To prevent hazardous situations:

- Adapt your driving style accordingly and drive carefully.
- Never fit more than one spare wheel/emergency spare wheel if the dimensions are different to those of the wheel being replaced.
- Only use a spare wheel/emergency spare wheel briefly if the dimensions are different to those of the wheel being replaced.
- Do not switch off ESP®.
- Have the spare wheel/emergency spare wheel in question replaced at the nearest qualified specialist workshop. Make sure

that the wheel/tyre dimensions and tyre type are correct.

When using an emergency spare wheel or spare wheel of a different size, you must not exceed the vehicle's maximum design speed of 80 km/h.

You should regularly check the pressure of all your tyres, including the emergency spare wheel, particularly prior to long trips, and correct the pressure as necessary (▷ page 319). The value on the wheel is valid.

Snow chains must not be fitted to emergency spare wheels.

General notes

You can ask for information regarding permitted emergency spare wheels at a Mercedes-Benz Service Centre.

An emergency spare wheel may also be fitted against the direction of rotation. Observe the time restriction on use as well as the speed limitation specified on the emergency spare wheel.

Replace the tyres after six years at the latest, regardless of wear. This also applies to the emergency spare wheel.

If you are driving with the emergency spare wheel fitted, the tyre pressure loss warning system or the tyre pressure monitor cannot function reliably. Restart the tyre pressure loss warning system or tyre pressure monitor only once the defective wheel has been replaced with a new wheel.

Vehicles with tyre pressure monitor: after an emergency spare wheel has been fitted, the system may still display the tyre pressure of the removed wheel for a few minutes. The value displayed for the position where the emergency spare wheel is fitted is not the same as the current tyre pressure of the emergency spare wheel.

Removing the emergency spare wheel

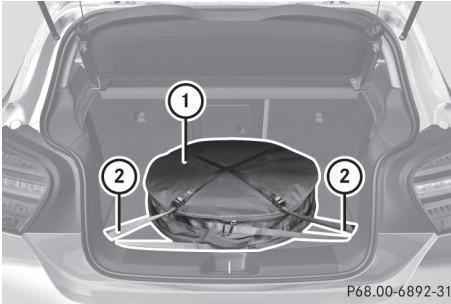

Vehicles with the "Minispare" emergency spare wheel:

The "Minispare" emergency spare wheel is secured in emergency spare wheel bag ① in the luggage compartment.

- ▶ Open the tailgate.
- ▶ Release securing straps ② on emergency spare wheel bag ①.
- ▶ Remove emergency spare wheel bag ① with the "Minispare" emergency spare wheel.
- ▶ Open emergency spare wheel bag ① and remove the "Minispare" emergency spare wheel.

Observe the instructions and safety notes in the "Changing a wheel" section (▷ page 325).

Information on technical data

i The technical data were determined in accordance with EU Directives. All data apply to the vehicle's standard equipment. The data may therefore differ for vehicles with optional equipment. You can obtain further information from a Mercedes-Benz Service Centre.

Vehicle electronics

Tampering with the engine electronics

! Only have work carried out on the engine electronics and its associated parts, such as control units, sensors, actuating components and connector leads, at a qualified specialist workshop. Vehicle components may otherwise wear more quickly and the vehicle's operating permit may be invalidated.

Fitting two-way radios and mobile phones (RF transmitters)

⚠ WARNING

The electromagnetic radiation from two-way radios can interfere with the vehicle electronics if they are manipulated or retrofitted incorrectly. This could jeopardise the operating safety of the vehicle. There is a risk of an accident.

You should have all work on electrical and electronic components carried out at a qualified specialist workshop.

⚠ WARNING

If you operate two-way radios incorrectly in the vehicle, their electromagnetic radiation can interfere with the vehicle electronics, for example if:

- the two-way radio is not connected to an exterior aerial
- the exterior aerial is not correctly mounted or is not low-reflection

This could jeopardise the operating safety of the vehicle. There is a risk of an accident.

Have the low-reflection exterior aerial fitted at a qualified specialist workshop. When operating two-way radios in the vehicle, always connect them to the low-reflection exterior aerial.

! The operating permit may be invalidated if the instructions for installation and use of two-way radios are not observed.

In particular, the following conditions must be complied with:

- only approved wavebands may be used
- observe the maximum permissible output in these wavebands
- only approved aerial positions may be used

Excessive levels of electromagnetic radiation may cause damage to your health and to the health of others. The use of an exterior aerial takes into consideration current scientific discussions surrounding the possible health risk posed by electromagnetic fields.

Observe the notes on operating mobile phones (> page 281).

The following aerial positions may be used for the correct installation of RF transmitters:

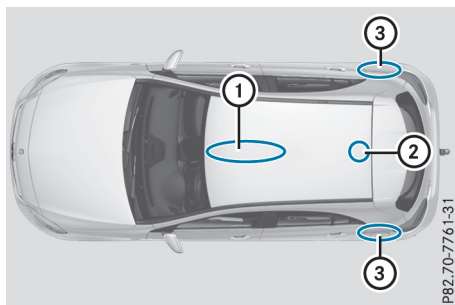

Approved aerial positions

- ① Front roof area
- ② Rear roof area
- ③ Rear wings

i On vehicles with a panorama sliding sunroof, fitting an aerial to the front or rear roof area is not permitted.

On the rear wings, it is recommended that you position the aerial on the side of the vehicle closest to the centre of the road.

Use Technical Specification ISO/TS 21609 (Road Vehicles - "EMC guidelines for installation of aftermarket radio frequency transmitting

equipment") when retrofitting RF transmitters. Comply with the legal requirements for add-on parts.

If your vehicle has fittings for two-way radio equipment, use the power supply or aerial connections intended for use with the basic fittings. Be sure to observe the manufacturer's additional instructions when installing.

Deviations in respect of wavebands, maximum transmission outputs or aerial positions must be approved by Mercedes-Benz.

The maximum transmission output (PEAK) at the base of the aerial must not exceed the following values:

Waveband	Maximum transmission output
Short wave 3–54 MHz	100 W
4 m waveband 74–88 MHz	30 W
2 m waveband 144–174 MHz	50 W
Trunked radio/Tetra 380–460 MHz	10 W
70 cm waveband 400–460 MHz	35 W
Mobile communications (2G/3G/4G)	10 W

The following can be used in the vehicle without restrictions:

- RF transmitters with a maximum transmission output of up to 100 mW
- RF transmitters with transmitter frequencies in the 380 - 410 MHz waveband and a maximum transmission output of up to 2 W (trunked radio/Tetra)
- Mobile phones (2G/3G/4G)

No restrictions apply with regard to the positioning of the aerial on the outside of the vehicle for the following wavebands:

- Trunked radio/Tetra
- 70 cm waveband
- 2G/3G/4G

Identification plates

Vehicle identification plate with vehicle identification number (VIN)

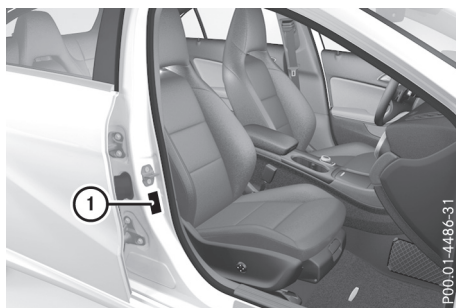

- Open the front right-hand door. You will see the vehicle identification plate ①.

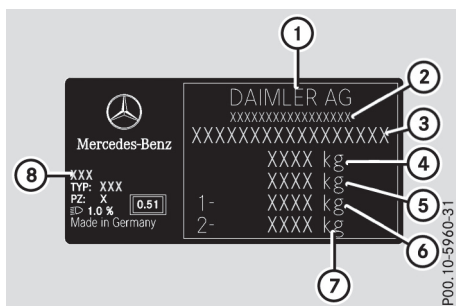

Vehicle identification plate (example: vehicles with a trailer tow hitch)

- ① Vehicle manufacturer (Daimler AG)
- ② EU type approval number (for certain countries only)
- ③ VIN
- ④ Maximum gross vehicle weight (kg)
- ⑤ Maximum gross weight of vehicle combination (kg) (for certain countries only)
- ⑥ Permissible front axle load (kg)
- ⑦ Permissible rear axle load (kg)
- ⑧ Paint code

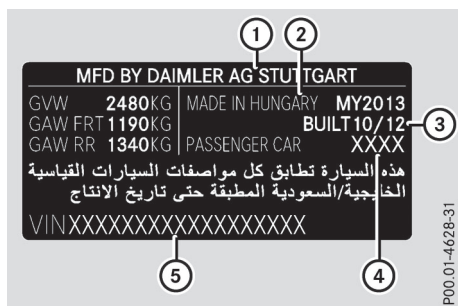

P00.01-4628-31

Example: vehicle identification plate (Kuwait)

- ① Vehicle manufacturer
- ② Place of manufacture
- ③ Date of manufacture
- ④ Vehicle model
- ⑤ VIN

i The data shown on the vehicle identification plate are sample data. The data are different for every vehicle and may differ from the data shown here. You can find the data applicable to your vehicle on the vehicle's identification plate.

Vehicle identification number (VIN)

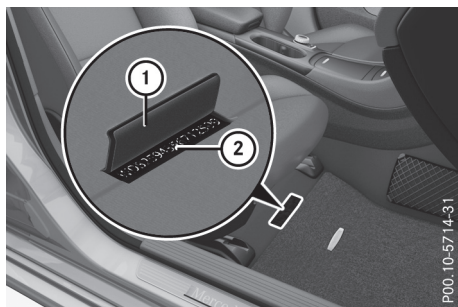

P00.10-5714-31

- ▶ Slide the right-hand front seat to its rearmost position.
- ▶ Fold floor covering ① upwards. VIN ② can be seen.

The VIN can also be found on the vehicle identification plate (▶ page 333).

For certain countries only: the VIN can also be found on the lower edge of the windscreen.

Engine number

The engine number is stamped into the crankcase. You can obtain further information from any qualified specialist workshop.

Service products and capacities

Important safety notes

WARNING

Service product can be poisonous and hazardous to health. There is a risk of injury. Observe the instructions on the respective original container when using, storing and disposing off service products. Always store service products in the sealed original container. Always keep service products out of the reach of children.

Environmental note

Dispose of service products in an environmentally-responsible manner.

Service products include the following:

- fuels
- lubricants (e.g. engine oil, transmission oil)
- coolant
- brake fluid
- windscreen washer fluid
- climate control system refrigerant

Components and service products must be matched. Use only products recommended by Mercedes-Benz. Damage caused by the use of products that have not been recommended is not covered by the Mercedes-Benz warranty or goodwill gestures. They are listed in this Mercedes-Benz Owner's Manual in the appropriate section.

You can identify service products approved by Mercedes-Benz by the following inscriptions on the container:

- MB-Freigabe (e.g. MB-Freigabe 229.51)
- MB-Approval (e.g. MB-Approval 229.51)

Other designations or recommendations indicate a level of quality or a specification in accordance with an MB Sheet Number (e.g. MB 229.5). They have not necessarily been approved by Mercedes-Benz.

Other designations, for example:

- 0W-30
- 5W-30
- 5W-40

i You can obtain further information at any qualified specialist workshop or on the Internet at <http://bevo.mercedes-benz.com>.

Fuel

Important safety notes

WARNING

Fuel is highly flammable. If you handle fuel incorrectly, there is a risk of fire and explosion.

You must avoid fire, naked flames, creating sparks and smoking. Switch off the engine and, if applicable, the auxiliary heating before refuelling.

WARNING

Fuels are poisonous and hazardous to health. There is a danger of injury.

Do not swallow fuel or let it come into contact with skin, eyes or clothing. Do not inhale fuel vapours. Keep fuels out of the reach of children.

If you or others come into contact with fuel, observe the following:

- Wash the fuel off any affected areas of skin with water and soap immediately.
- If you get fuel in your eyes, rinse them thoroughly with clean water immediately. Seek immediate medical attention.
- If fuel is swallowed, seek immediate medical attention. Do not induce vomiting.
- Change any clothing that has come into contact with fuel immediately.

Tank capacity

The total capacity of the fuel tank may vary, depending on the vehicle equipment.

Model	Total capacity
A 180 d BlueEFFICIENCY Edition	40.0 l
Models with 4MATIC	56.0 l
All other models	50.0 l

Model	Of which reserve fuel
Mercedes-AMG vehicles	Approx. 8.0 l
All other models	Approx. 6.0 l

Petrol

Fuel grade

! Do not use diesel to refuel vehicles with a petrol engine. Do not switch on the ignition if you accidentally refuel with the wrong fuel. Otherwise, the fuel will enter the fuel system. Even small amounts of the wrong fuel can result in damage to the fuel system and the engine. Notify a qualified specialist workshop and have the fuel tank and fuel lines drained completely.

! Only refuel using unleaded petrol with at least 95 RON, which conforms to the European standard EN 228 or E DIN or an equivalent specification.

Fuel of this specification may contain up to 10% ethanol. Your vehicle is suitable for use with E10 fuel. You may refuel your vehicle using E10 fuel.

Fuel that does not conform to EN 228 can lead to increased wear as well as damage to the fuel system, engine and exhaust system.

! Only use the fuel recommended. Operating the vehicle with other fuels can lead to damage to the fuel system, engine and exhaust system.

! Do not use the following:

- petrol with more than 10% ethanol
- E100 (100% ethanol)

- petrol with methanol
- M100 (100% methanol)
- petrol with additives containing metal
- diesel

Do not mix such fuels with the fuel recommended for your vehicle.

You will usually find information about the fuel grade on the fuel pump. If you cannot find the label on the fuel pump, ask the filling station staff.

A 200, A 250, A 250 4MATIC, A 250 Sport, A 250 Sport 4MATIC: as a temporary measure, if the recommended fuel is not available, you may also use regular unleaded petrol with an octane rating of 93 RON.

All other models: as a temporary measure, if the recommended fuel is not available, you may also use regular unleaded petrol with an octane rating of 91 RON. This may reduce engine performance and increase fuel consumption. Avoid driving at full throttle and sudden acceleration. Never refuel using fuel with a lower RON.

i In some countries, the petrol available may not be sufficiently low in sulphur. This fuel can temporarily produce unpleasant odours, especially on short journeys. As soon as sulphur-free fuel (sulphur content < 10 ppm) is used for refuelling, the odours are reduced.

i The fuels you can use in your vehicle may differ from the information in the Owner's Manual depending on the country. The fuels that have been approved for your vehicle can be found on the instruction label on the inside of the fuel filler flap.

Information on refuelling (▷ page 155).

Mercedes-AMG vehicles

! Only refuel using super unleaded petrol with at least 98 ROZ, that conforms to European standard EN 228 or an equivalent specification.

You can otherwise impair engine output or damage the engine.

Fuel of this specification may contain up to 10% ethanol. Your vehicle is suitable for use with E10 fuel. You may refuel your vehicle using E10 fuel.

! As a temporary measure, if the recommended fuel is not available, you may also use unleaded petrol with an octane rating of 95 RON. This may reduce engine perform-

ance and increase fuel consumption. As much as possible, avoid driving at full throttle.

! As a temporary measure, if the recommended fuel is not available, you may also use unleaded petrol in emergencies with an octane rating of 91 RON.

Doing so results in noticeably higher fuel consumption, and the engine power output is noticeably reduced. Avoid driving at full throttle.

If no fuel other than petrol with 91 RON or a lower grade is available, you should have the vehicle adapted to run on this fuel at a qualified specialist workshop.

Additives

! Operating the engine with fuel additives added later can lead to engine failure. Do not mix fuel additives with fuel. This does not include additives for the removal and prevention of residue build-up. Petrol must only be mixed with additives recommended by Mercedes-Benz. Observe the instructions for use in the product description. More information about recommended additives can be obtained from any Mercedes-Benz Service Centre.

Mercedes-Benz recommends that you use fuel brands that have additives.

The quality of the fuel available in some countries may not be sufficient. Residue could build up in the fuel injection system as a result. In this case, in consultation with a Mercedes-Benz Service Centre, the petrol should be mixed with the cleaning additive recommended by Mercedes-Benz. Always observe the notes and mixing ratios specified on the container.

Diesel

Fuel grade

WARNING

If you mix diesel fuel with petrol, the flash point of this fuel mixture is lower than that of pure diesel fuel. When the engine is running, components in the exhaust system may overheat unnoticed. There is a risk of fire.

Never refuel with petrol. Never add petrol to diesel fuel.

! When refuelling, only use diesel fuel that conforms to the European standard EN 590 or is of equivalent quality. Fuel that does not conform to EN 590 can lead to increased wear as well as damage to the engine and exhaust system.

! Do not use the following:

- marine diesel
- heating oil
- bio-diesel
- vegetable oil
- petrol
- paraffin
- kerosene

Do not mix such fuels with diesel fuel and do not use any special additives. Otherwise, engine damage may occur.

! **Vehicles with diesel particle filters:** in countries outside the EU, only use low sulphur Euro diesel with a sulphur content of under 50 ppm. Otherwise, the emission control system could be damaged.

! **Vehicles without a diesel particle filter:** in countries where only diesel fuel with a high sulphur content is available, you will need to carry out your vehicle's oil change at shorter intervals. More information about the interval for oil change can be obtained from any qualified specialist workshop.

Usually you will find information about the fuel grade on the pump. If you cannot find the label on the petrol pump, ask the filling station staff. Information on refuelling (▷ page 155).

Low outside temperatures

In winter months, diesel fuel with an improved cold flow quality is available. In Europe, the EN 590 standard defines various climate-dependent temperature categories. Malfunctions can be avoided by refuelling with diesel fuel that corresponds to the climatic specifications outlined in EN 590. At unusually low outside temperatures, it is possible that the flow characteristics of the diesel fuel could be insufficient. Accordingly, diesel fuel from warmer areas may not be suitable for operation in colder climatic conditions.

i Further information on country-specific fuel properties and fuel types with low-tempera-

ture resistance can be obtained from oil companies, e.g. at filling stations.

Engine oil

General notes



When handling engine oil, observe the important safety notes on service products (▷ page 334). The quality of the engine oil is decisive for the function and service life of an engine. After extensive tests, Mercedes-Benz approves engine oils that correspond to the current technical standard.

Therefore, only Mercedes-Benz-approved engine oils may be used in Mercedes-Benz engines.

Further information on tested and approved engine oils can be obtained from any Mercedes-Benz Service Centre. Mercedes-Benz recommends that you have the engine oil change carried out at a qualified specialist workshop. Mercedes-Benz approval is indicated on the oil container by the inscription "MB-Freigabe" or "MB-Approval" and the corresponding designation, e.g. MB-Freigabe or MB-Approval 229.51.

You can call up an overview of approved engine oils on the Internet at <http://bevo.mercedes-benz.com> by entering the designation, e.g. 229.5.

The table shows which engine oils have been approved for your vehicle.

You can find the correct values for your model with the help of the VIN on the vehicle identification plate (▷ page 333).

Missing values were not available at the time of going to print.

Petrol engines: for certain countries, different engine oils can be used, provided that the maintenance intervals are reduced. For more information, please contact a qualified specialist workshop.

Petrol engines	MB-Freigabe or MB-Approval
All models	229.5

Diesel engines with a diesel particulate filter	MB-Freigabe or MB-Approval
A 160 d A 180 d A 180 d BlueEFFICIENCY Edition	226.51, 229.31, 229.51, 229.52
All other models	228.51, 229.31, 229.51, 229.52

Diesel engines without a diesel particulate filter	MB-Freigabe or MB-Approval
All models	

Use only SAE 0W-40 or SAE 5W-40 engine oils for Mercedes-AMG vehicles.

i If the engine oils listed in the table are not available, you may add the following engine oils until the next engine oil change:

- Petrol engines: MB-Freigabe or MB-Approval 229.3 or ACEA A3/B3
- Diesel engines: MB-Freigabe or MB-Approval 229.3, 229.5 or ACEA C3

It may be used only once and the topping-up quantity must not exceed 1.0 l.

Filling capacities

The following values refer to an engine oil change, including the oil filter.

Model	Replacement amount
A 160 A 180 A 180 BlueEFFICIENCY Edition A 200	5.8 l
A 160 d A 180 d A 180 d BlueEFFICIENCY Edition	4.5 l
A 200 d A 200 d 4MATIC A 220 d A 220 d 4MATIC	6.5 l
Mercedes-AMG vehicles	5.5 l
All other models	5.6 l

Additives

! Do not use any additives with the engine oil. This could damage the engine.

Brake fluid

WARNING

The brake fluid continuously absorbs moisture from the air. This results in the boiling point of the brake fluid lowering. If the boiling point of the brake fluid is too low, vapour pockets may form when the brakes are subjected to a heavy load. This would impair braking efficiency. There is a risk of an accident. Have the brake fluid renewed at the prescribed intervals.

When handling brake fluid, observe the important safety notes on service products (▷ page 334).

The brake fluid change intervals can be found in the Service Booklet.

Only use brake fluid approved by Mercedes-Benz according to MB-Freigabe or MB-Approval 331.0.

Information about approved brake fluid can be obtained at any qualified specialist workshop or

on the Internet at
<http://bevo.mercedes-benz.com>.

- ❗ Have the brake fluid regularly replaced at a qualified specialist workshop and the replacement confirmed in the Service Booklet.

Coolant

Important safety notes

WARNING

If antifreeze comes into contact with hot components in the engine compartment, it may ignite. There is a risk of fire and injury.

Let the engine cool down before you top up the antifreeze. Make sure that antifreeze is not spilled next to the filler neck. Thoroughly clean the antifreeze from components before starting the engine.

- ❗ Only add coolant that has been premixed with the desired antifreeze protection. You could otherwise damage the engine.

Further information on coolants can be found in the Mercedes-Benz Specifications for Service Products, MB BeVo 310.1, e.g. on the Internet at

<http://bevo.mercedes-benz.com>. Or contact a qualified specialist workshop.

- ❗ Always use a suitable coolant mixture, even in countries where high temperatures prevail. Otherwise, the engine cooling system is not sufficiently protected from corrosion and overheating.

- ❗ Have the coolant regularly replaced at a qualified specialist workshop and the replacement confirmed in the Service Booklet.

Comply with the important safety notes for service products when handling coolant (▷ page 334).

The coolant is a mixture of water and corrosion inhibitor/antifreeze concentrate. It is responsible for the following:

- anti-corrosion protection
- antifreeze protection
- raising the boiling point

If corrosion inhibitor/antifreeze concentrate is present in the correct concentration, the boiling

point of the coolant during operation will be approximately 130 °C.

The antifreeze/anti-corrosion additive concentration in the engine cooling system should:

- Be at least 50%. This will protect the engine cooling system against freezing down to approximately -37 °C.
- Not exceed 55% (antifreeze protection down to -45 °C). Heat will otherwise not be dissipated as effectively.

Mercedes-Benz recommends a coolant or corrosion inhibitor/antifreeze concentrate in accordance with MB Specifications for Service Products 310.1.

- ❗ When the vehicle is first delivered, it is filled with a coolant mixture that ensures adequate antifreeze and corrosion protection.
- ❗ The coolant is checked at every maintenance interval at a qualified specialist workshop.

Windscreen washer system

Important safety notes

WARNING

If windscreen washer concentrate comes into contact with hot components of the engine or the exhaust system, it can ignite. There is a risk of fire and injury.

Make sure the windscreen washer concentrate does not come into contact with the filler neck.

- ❗ Only the washer fluids SummerFit and WinterFit can be mixed. Otherwise, the spraying nozzles could become blocked.

Do not use distilled or de-ionised water. Otherwise, the level sensor may give a false reading. When handling washer fluid, observe the important safety notes on service products (▷ page 334).

At temperatures above freezing:

- ▶ Fill the washer fluid reservoir with a mixture of water and washer fluid, e.g. MB SummerFit. Mix 1 part MB SummerFit to 100 parts water.

At temperatures below freezing:

- Fill the washer fluid reservoir with a mixture of water and washer fluid, e.g. MB WinterFit.

For the correct mixing ratio, refer to the information on the antifreeze reservoir.

- ❗ Add washer fluid concentrate, e.g. MB SummerFit or MB WinterFit, to the washer fluid all year round.

Vehicle data

General notes

Please note that for the specified vehicle data:

- the heights specified may vary as a result of:
 - tyres
 - load
 - condition of the suspension
 - items of optional equipment
- items of optional equipment reduce the payload
- vehicle-specific weight information can be found on the vehicle identification plate (▷ page 333)
- for certain countries only: you can find vehicle-specific vehicle data in the COC documents (CERTIFICATE OF CONFORMITY), these documents are delivered with your vehicle

Dimensions and weights

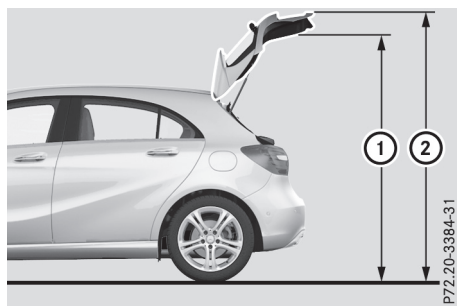

Model	① Maximum headroom	② Height when opened
A 160 A 160 d A 180 A 180 d (176.012, vehicles with manual transmission)	1856 mm	1975 mm
A 180 d (176.012, vehicles with automatic transmission)	1847 mm	1975 mm
A 180 BlueEFFICIENCY Edition A 180 d BlueEFFICIENCY Edition	1847 mm	1960 mm
A 200 A 200 d A 200 d 4MATIC A 220 d A 220 d 4MATIC	1857 mm	1976 mm
A 220 4MATIC	1861 mm	1976 mm
Mercedes-AMG vehicles	1840 mm	1959 mm
All other models	1861 mm	1980 mm

All models

Vehicle width including exterior mirrors	2022 mm
Vehicle width excluding exterior mirrors	1780 mm
Wheelbase	2699 mm
Maximum roof load	100 kg

Model Vehicle length

Mercedes-AMG vehicles	4359 mm
All other models	4299 mm

Model	Manual transmission
A 180 BlueEFFICIENCY Edition	1500 kg

Model	Automatic transmission
A 200 d 4MATIC	1500 kg
A 220 4MATIC	1500 kg
A 220 d	1500 kg
A 220 d 4MATIC	1500 kg
A 250 4MATIC	1500 kg

Permissible trailer load, braked (at a minimum gradient-climbing capability of 12% from a standstill)

Not all models can tow a trailer. For further information, see (▷ page 197).

Model	Manual transmission	Automatic transmission
A 160	1000 kg	1000 kg
A 160 d	1200 kg	1200 kg
A 180	1200 kg	1200 kg
A 180 d	1200 kg	1200 kg
A 200	1400 kg	1400 kg
A 200 d	1500 kg	1500 kg
A 250	1500 kg	1500 kg

Model	Manual transmission
A 180 BlueEFFICIENCY Edition	1200 kg

Model	Automatic transmission
A 200 d 4MATIC	1500 kg
A 220 4MATIC	1500 kg
A 220 d	1500 kg
A 220 d 4MATIC	1500 kg
A 250 4MATIC	1500 kg

Permissible trailer load, unbraked

Not all models can tow a trailer. For further information, see (▷ page 197).

Model	Manual transmission	Automatic transmission
A 160	685 kg	695 kg
A 160 d	695 kg	710 kg
A 180	685 kg	695 kg
A 180 d	695 kg	710 kg
A 200	685 kg	695 kg
A 200 d	725 kg	740 kg
A 250	695 kg	715 kg

Model	Manual transmission
A 180 BlueEFFICIENCY Edition	685 kg

Model	Automatic transmission
A 200 d 4MATIC	750 kg
A 220 4MATIC	750 kg
A 220 d	740 kg
A 220 d 4MATIC	750 kg
A 250 4MATIC	750 kg

Maximum drawbar load

! Use a drawbar noseweight as close as possible to the maximum permissible noseweight. Do not use a noseweight of less than 50kg, otherwise the trailer may come loose.

Note that the payload and the rear axle load are reduced by the actual payload.

Not all models can tow a trailer. For further information, see (> page 197).

The drawbar load is not included in the trailer load.

Missing values were not available at the time of going to print.

Model	Manual transmission	Automatic transmission
A 160	75 kg	75 kg
A 160 d	75 kg	75 kg
A 180	75 kg	75 kg
A 180 d	75 kg	75 kg
A 200	75 kg	75 kg
A 200 d	75 kg	75 kg
A 250	75 kg	75 kg

Model	Manual transmission
A 180 BlueEFFICIENCY Edition	75 kg

Model	Automatic transmission
A 200 d 4MATIC	75 kg
A 220 4MATIC	75 kg
A 220 d	75 kg
A 220 d 4MATIC	75 kg
A 250 4MATIC	75 kg

The actual drawbar load may not be higher than the specified value. The value can be found on the trailer tow hitch or trailer identification plates. The lowest weight applies.

You can attach carrier systems, e.g. bicycle racks or load-bearing implements, on the ball coupling. The maximum payload of 75 kg applies when using carrier systems on the ball coupling.

Permissible rear axle load during trailer towing

Not all models can tow a trailer. For further information, see (▷ page 197).

Missing values were not available at the time of going to print.

Model	Manual transmission	Automatic transmission
A 160	990 kg	970 kg
A 160 d	990 kg	970 kg
A 180	990 kg	970 kg
A 180 d	990 kg	970 kg
A 200	990 kg	970 kg
A 200 d	985 kg	960 kg
A 250	990 kg	970 kg

Model	Manual transmission
A 180 BlueEFFICIENCY Edition	980 kg

Model	Automatic transmission
A 200 d 4MATIC	1000 kg
A 220 4MATIC	1020 kg
A 220 d	960 kg
A 220 d 4MATIC	1000 kg
A 250 4MATIC	1020 kg

Publication details

Internet

Further information about Mercedes-Benz vehicles and about Daimler AG can be found on the following websites:

<http://www.mercedes-benz.com>

<http://www.daimler.com>

Editorial office

You are welcome to forward any queries or suggestions you may have regarding this Owner's Manual to the technical documentation team at the following address:

Daimler AG, HPC: CAC, Customer Service,
70546 Stuttgart, Germany

©Daimler AG: not to be reprinted, translated or otherwise reproduced, in whole or in part, without written permission from Daimler AG.

Vehicle manufacturer

Daimler AG
Mercedesstrasse 137
70327 Stuttgart
Germany

Your Owner's Manuals



Digital - in the vehicle

Familiarise yourself with the contents of the Owner's Manual directly via the vehicle's multimedia system (Menu item "Vehicle").



Printed manual - in the vehicle

In addition to the vehicle's Owner's Manual, you can obtain the complete multimedia system Supplement from your Mercedes-Benz Service Centre.



Digital - on the Internet

You can find the Owner's Manual on the Mercedes-Benz homepage.



Digital - as an App

The Mercedes-Benz Guides App is available for free on the Apple® App store or Google Play.

Apple® iOS



Android™



1765845601Z102